

Digital Temperature Controllers

User's Manual

E5CC

E5EC

1
Introduction

2
Preparations

3
Part Names and
Basic Procedures

4
Basic
Operation

5
Advanced
Operations

6
Parameters

7
User Calibration

A
Appendices

I
Index



H174-E1-01

Preface

The E5CC and E5EC are Digital Controllers. The main functions and characteristics of these Digital Controllers are as follows:

- Any of the following types of input can be used: thermocouple, platinum resistance thermometer, infrared sensor, analog voltage, or analog current.
- Either standard or heating/cooling control can be performed.
- Both auto-tuning and self-tuning are supported.
- Event inputs can be used to switch set points (multi-SP function), switch between RUN and STOP status, switch between automatic and manual operation, start/reset the simple program function, and perform other operations.
- Heater burnout detection and heater short (HS) alarms functions are supported. (Applicable models with heater burnout detection function.)
- Communications are supported. (Applicable to models with communications.)
- User calibration of the sensor input is supported.
- User calibration of the transfer output is supported. (Applicable to models with a transfer output.)
- The structure is waterproof (IP66).
- Conforms to UL, CSA, and IEC safety standards and EMC Directive.

This manual describes how to use the E5CC/E5EC. Read this manual thoroughly and be sure you understand it before attempting to use the Digital Controller and use the Digital Controller correctly according to the information provided. Keep this manual in a safe place for easy reference. Refer to the following manual for further information on communications: *E5CC/E5EC Digital Temperature Controllers Communications Manual* (Cat. No. H175).

© OMRON, 2011

All rights reserved. No part of this publication may be reproduced, stored in a retrieval system or transmitted, in any form, or by any means, mechanical, electronic, photocopying, recording, or otherwise, without the prior written permission of OMRON.

No patent liability is assumed with respect to the use of the information contained herein. Moreover, because OMRON is constantly striving to improve its high-quality products, the information contained in this manual is subject to change without notice. Every precaution has been taken in the preparation of this manual. Nevertheless, OMRON assumes no responsibility for errors or omissions. Neither is any liability assumed for damages resulting from the use of the information contained in this publication.

Read and Understand this Manual

Please read and understand this manual before using the products. Please consult your OMRON representative if you have any questions or comments.

Warranty and Limitations of Liability

WARRANTY

OMRON's exclusive warranty is that the products are free from defects in materials and workmanship for a period of one year (or other period if specified) from date of sale by OMRON.

OMRON MAKES NO WARRANTY OR REPRESENTATION, EXPRESS OR IMPLIED, REGARDING NON-INFRINGEMENT, MERCHANTABILITY, OR FITNESS FOR PARTICULAR PURPOSE OF THE PRODUCTS. ANY BUYER OR USER ACKNOWLEDGES THAT THE BUYER OR USER ALONE HAS DETERMINED THAT THE PRODUCTS WILL SUITABLY MEET THE REQUIREMENTS OF THEIR INTENDED USE. OMRON DISCLAIMS ALL OTHER WARRANTIES, EXPRESS OR IMPLIED.

LIMITATIONS OF LIABILITY

OMRON SHALL NOT BE RESPONSIBLE FOR SPECIAL, INDIRECT, OR CONSEQUENTIAL DAMAGES, LOSS OF PROFITS OR COMMERCIAL LOSS IN ANY WAY CONNECTED WITH THE PRODUCTS, WHETHER SUCH CLAIM IS BASED ON CONTRACT, WARRANTY, NEGLIGENCE, OR STRICT LIABILITY.

In no event shall the responsibility of OMRON for any act exceed the individual price of the product on which liability is asserted.

IN NO EVENT SHALL OMRON BE RESPONSIBLE FOR WARRANTY, REPAIR, OR OTHER CLAIMS REGARDING THE PRODUCTS UNLESS OMRON'S ANALYSIS CONFIRMS THAT THE PRODUCTS WERE PROPERLY HANDLED, STORED, INSTALLED, AND MAINTAINED AND NOT SUBJECT TO CONTAMINATION, ABUSE, MISUSE, OR INAPPROPRIATE MODIFICATION OR REPAIR.

Application Considerations

SUITABILITY FOR USE

OMRON shall not be responsible for conformity with any standards, codes, or regulations that apply to the combination of products in the customer's application or use of the products.

At the customer's request, OMRON will provide applicable third party certification documents identifying ratings and limitations of use that apply to the products. This information by itself is not sufficient for a complete determination of the suitability of the products in combination with the end product, machine, system, or other application or use.

The following are some examples of applications for which particular attention must be given. This is not intended to be an exhaustive list of all possible uses of the products, nor is it intended to imply that the uses listed may be suitable for the products:

- Outdoor use, uses involving potential chemical contamination or electrical interference, or conditions or uses not described in this manual.
- Nuclear energy control systems, combustion systems, railroad systems, aviation systems, medical equipment, amusement machines, vehicles, safety equipment, and installations subject to separate industry or government regulations.
- Systems, machines, and equipment that could present a risk to life or property.

Please know and observe all prohibitions of use applicable to the products.

NEVER USE THE PRODUCTS FOR AN APPLICATION INVOLVING SERIOUS RISK TO LIFE OR PROPERTY WITHOUT ENSURING THAT THE SYSTEM AS A WHOLE HAS BEEN DESIGNED TO ADDRESS THE RISKS, AND THAT THE OMRON PRODUCTS ARE PROPERLY RATED AND INSTALLED FOR THE INTENDED USE WITHIN THE OVERALL EQUIPMENT OR SYSTEM.

PROGRAMMABLE PRODUCTS

OMRON shall not be responsible for the user's programming of a programmable product, or any consequence thereof.

Disclaimers

CHANGE IN SPECIFICATIONS

Product specifications and accessories may be changed at any time based on improvements and other reasons.

It is our practice to change model numbers when published ratings or features are changed, or when significant construction changes are made. However, some specifications of the products may be changed without any notice. When in doubt, special model numbers may be assigned to fix or establish key specifications for your application on your request. Please consult with your OMRON representative at any time to confirm actual specifications of purchased products.

DIMENSIONS AND WEIGHTS

Dimensions and weights are nominal and are not to be used for manufacturing purposes, even when tolerances are shown.

PERFORMANCE DATA

Performance data given in this manual is provided as a guide for the user in determining suitability and does not constitute a warranty. It may represent the result of OMRON's test conditions, and the users must correlate it to actual application requirements. Actual performance is subject to the OMRON Warranty and Limitations of Liability.

ERRORS AND OMISSIONS

The information in this manual has been carefully checked and is believed to be accurate; however, no responsibility is assumed for clerical, typographical, or proofreading errors, or omissions.

Safety Precautions

Definition of Precautionary Information





The following notation is used in this manual to provide precautions required to ensure safe usage of the product.

The safety precautions that are provided are extremely important to safety. Always read and heed the information provided in all safety precautions.

The following notation is used.

	CAUTION	Indicates a potentially hazardous situation which, if not avoided, may result in minor or moderate injury or in property damage.
---	----------------	--

Symbols

Symbol		Meaning
Caution		<ul style="list-style-type: none"> General Caution Indicates non-specific general cautions, warnings, and dangers.
		<ul style="list-style-type: none"> Electrical Shock Caution Indicates possibility of electric shock under specific conditions.
Prohibition		<ul style="list-style-type: none"> General Prohibition Indicates non-specific general prohibitions.
Mandatory Caution		<ul style="list-style-type: none"> General Caution Indicates non-specific general cautions, warnings, and dangers.

● Safety Precautions

 **CAUTION**

Minor injury due to electric shock may occasionally occur.
Do not touch the terminals while power is being supplied.



Electric shock, fire, or malfunction may occasionally occur.
Do not allow metal objects, conductors, cuttings from installation work, or moisture to enter the Digital Controller or a Setup Tool port. Attach the cover to the front-panel Setup Tool port whenever you are not using it to prevent foreign objects from entering the port.



Minor injury from explosion may occasionally occur.
Do not use the product where subject to flammable or explosive gas.



Fire may occasionally occur.
Do not allow dirt or other foreign objects to enter a Setup Tool port, or between the pins on the connectors on the Setup Tool cable.



Minor electric shock, fire, or malfunction may occasionally occur.
Never disassemble, modify, or repair the product or touch any of the internal parts.



CAUTION - Risk of Fire and Electric Shock

- (a) This product is UL recognized as Open Type Process Control Equipment. It must be mounted in an enclosure that does not allow fire to escape externally.
- (b) More than one disconnect switch may be required to de-energize the equipment before servicing.
- (c) Signal inputs are SELV, limited energy. ^{*1}
- (d) Caution: To reduce the risk of fire or electric shock, do not interconnect the outputs of different Class 2 circuits. ^{*2}



If the output relays are used past their life expectancy, contact fusing or burning may occasionally occur.
Always consider the application conditions and use the output relays within their rated load and electrical life expectancy. The life expectancy of output relays varies considerably with the output load and switching conditions.



^{*1} A SELV circuit is one separated from the power supply with double insulation or reinforced insulation, that does not exceed 30 V r.m.s. and 42.4 V peak or 60 VDC.

^{*2} A class 2 power supply is one tested and certified by UL as having the current and voltage of the secondary output restricted to specific levels.

 **CAUTION**

Loose screws may occasionally result in fire.
Tighten the terminal screws to the specified torque of 0.43 to 0.58 N·m.



Set the parameters of the product so that they are suitable for the system being controlled. If they are not suitable, unexpected operation may occasionally result in property damage or accidents.



A malfunction in the Digital Controller may occasionally make control operations impossible or prevent alarm outputs, resulting in property damage. To maintain safety in the event of malfunction of the Digital Controller, take appropriate safety measures, such as installing a monitoring device on a separate line.



Precautions for Safe Use

Be sure to observe the following precautions to prevent operation failure, malfunction, or adverse affects on the performance and functions of the product. Not doing so may occasionally result in unexpected events. Use the product within the specifications.

- The product is designed for indoor use only. Do not use or store the product outdoors or in any of the following locations.

Locations directly subject to heat radiated from heating equipment.

Locations subject to splashing liquid or oil atmosphere.

Locations subject to direct sunlight.

Locations subject to dust or corrosive gas (in particular, sulfide gas and ammonia gas).

Locations subject to intense temperature change.

Locations subject to icing and condensation.

Locations subject to vibration and large shocks.

- Use and store the Digital Controller within the rated ambient temperature and humidity. Gang-mounting two or more Digital Controllers, or mounting Digital Controllers above each other may cause heat to build up inside the Digital Controllers, which will shorten their service life. In such a case, use forced cooling by fans or other means of air ventilation to cool down the Digital Controllers.
- To allow heat to escape, do not block the area around the product. Do not block the ventilation holes on the product.
- Be sure to wire properly with correct polarity of terminals.
- Use the specified size of crimped terminals (M3, width of 5.8 mm or less) for wiring. To connect bare wires to the terminal block, use copper braided or solid wires with a gage of AWG24 to AWG18 (equal to a cross-sectional area of 0.205 to 0.8231 mm²). (The stripping length is 6 to 8 mm.) Up to two wires of the same size and type, or two crimped terminals can be inserted into a single terminal.
- Do not wire the terminals that are not used.
- To avoid inductive noise, keep the wiring for the Digital Controller's terminal block away from power cables that carry high voltages or large currents. Also, do not wire power lines together with or parallel to Digital Controller wiring. Using shielded cables and using separate conduits or ducts is recommended.

Attach a surge suppressor or noise filter to peripheral devices that generate noise (in particular, motors, transformers, solenoids, magnetic coils or other equipment that have an inductance component).

When a noise filter is used at the power supply, first check the voltage or current, and attach the noise filter as close as possible to the Digital Controller.

Allow as much space as possible between the Digital Controller and devices that generate powerful high frequencies (high-frequency welders, high-frequency sewing machines, etc.) or surge.

- Use this product within the rated load and power supply.
- Make sure that the rated voltage is attained within 2 seconds of turning ON the power using a switch or relay contact. If the voltage is applied gradually, the power may not be reset or output malfunctions may occur.
- Make sure that the Digital Controller has 30 minutes or more to warm up after turning ON the power before starting actual control operations to ensure the correct temperature display.
- When executing self-tuning, turn ON power for the load (e.g., heater) at the same time as or before supplying power to the Digital Controller. If power is turned ON for the Digital Controller before turning ON power for the load, self-tuning will not be performed properly and optimum control will not be achieved.

- A switch or circuit breaker should be provided close to Digital Controller. The switch or circuit breaker should be within easy reach of the operator, and must be marked as a disconnecting means for Digital Controller.
- Do not use paint thinner or similar chemical to clean with. Use standard grade alcohol.
- Design the system (e.g., control panel) considering the 2 seconds of delay in setting the Digital Controller's output after the power supply is turned ON.
- The output will turn OFF when you move to the Initial Setting Level. Take this into consideration when performing control.
- The number of non-volatile memory write operations is limited. Therefore, use RAM write mode when frequently overwriting data during communications or other operations.
- Use suitable tools when taking the Digital Controller apart for disposal. Sharp parts inside the Digital Controller may cause injury.
- Do not connect cables to both the front-panel Setup Tool port and the top-panel Setup Tool port at the same time. The Digital Controller may be damaged or may malfunction.
- Do not exceed the communications distance that is given in the specifications. Use the specified communications cable.
- Do not turn the power supply to the Digital Controller ON or OFF while the USB-Serial Conversion Cable is connected. The Digital Controller may malfunction.

Installation Precautions

● Service Life

Use the Digital Controller within the following temperature and humidity ranges:

Temperature: -10 to 55°C (with no icing or condensation), Humidity: 25% to 85%

If the Digital Controller is installed inside a control board, the ambient temperature must be kept to under 55°C , including the temperature around the Controller.

The service life of electronic devices like Digital Controllers is determined not only by the number of times the relay is switched but also by the service life of internal electronic components. Component service life is affected by the ambient temperature: the higher the temperature, the shorter the service life and, the lower the temperature, the longer the service life. Therefore, the service life can be extended by lowering the temperature of the Digital Controller.

When two or more Digital Controllers are mounted horizontally close to each other or vertically next to one another, the internal temperature will increase due to heat radiated by the Digital Controllers and the service life will decrease. In such a case, use forced cooling by fans or other means of air ventilation to cool down the Digital Controllers. When providing forced cooling, however, be careful not to cool down the terminals sections alone to avoid measurement errors.

● Ambient Noise

To avoid inductive noise, keep the wiring for the Digital Controller's terminal block wiring away from power cables carrying high voltages or large currents. Also, do not wire power lines together with or parallel to Digital Controller wiring. Using shielded cables and using separate conduits or ducts is recommended.

Attach a surge suppressor or noise filter to peripheral devices that generate noise (in particular, motors, transformers, solenoids, magnetic coils or other equipment that have an inductance component). When a noise filter is used at the power supply, first check the voltage or current, and attach the noise filter as close as possible to the Digital Controller.

Allow as much space as possible between the Digital Controller and devices that generate powerful high frequencies (high-frequency welders, high-frequency sewing machines, etc.) or surge.

● Ensuring Measurement Accuracy

When extending or connecting the thermocouple lead wire, be sure to use compensating wires that match the thermocouple types.

When extending or connecting the lead wire of the platinum resistance thermometer, be sure to use wires that have low resistance and keep the resistance of the three lead wires the same.

Mount the Digital Controller so that it is horizontally level.

If the measurement accuracy is low, check to see if input shift has been set correctly.

● Waterproofing

The degree of protection is as shown below. Sections without any specification on their degree of protection or those with IP□0 are not waterproof.

Front panel: IP66

Rear case: IP20, Terminal section: IP00

When waterproofing is required, insert the Waterproof Packing on the backside of the front panel. Keep the Port Cover on the front-panel Setup Tool port of the E5EC securely closed. The degree of protection when the Waterproof Packing is used is IP66. To maintain an IP66 degree of protection, the Waterproof Packing and the Port Cover for the front-panel Setup Tool port must be periodically replaced because they may deteriorate, shrink, or harden depending on the operating environment. The replacement period will vary with the operating environment. Check the required period in the actual application. Use 3 years or sooner as a guideline. If the Waterproof Packing and Port Cover are not periodically replaced, waterproof performance may not be maintained. If a waterproof structure is not required, then the Waterproof Packing does not need to be installed.

Precautions for Operation

- It takes approximately two seconds for the outputs to turn ON from after the power supply is turned ON. Due consideration must be given to this time when incorporating Digital Controllers into a control panel or similar device.
- Make sure that the Digital Controller has 30 minutes or more to warm up after turning ON the power before starting actual control operations to ensure the correct temperature display.
- When using self-tuning, turn ON power for the load (e.g., heater) at the same time as or before supplying power to the Digital Controller. If power is turned ON for the Digital Controller before turning ON power for the load, self-tuning will not be performed properly and optimum control will not be achieved. When starting operation after the Digital Controller has warmed up, turn OFF the power and then turn it ON again at the same time as turning ON power for the load. (Instead of turning the Digital Controller OFF and ON again, switching from STOP Mode to RUN Mode can also be used.)
- Avoid using the Digital Controller in places near a radio, television set, or wireless installing. The Digital Controller may cause radio disturbance for these devices.

Preparations for Use

Be sure to thoroughly read and understand the manual provided with the product, and check the following points.

Timing	Check point	Details
Purchasing the product	Product appearance	After purchase, check that the product and packaging are not dented or otherwise damaged. Damaged internal parts may prevent optimum control.
	Product model and specifications	Make sure that the purchased product meets the required specifications.
Setting the Unit	Product installation location	Provide sufficient space around the product for heat dissipation. Do not block the vents on the product.
Wiring	Terminal wiring	Do not subject the terminal screws to excessive stress (force) when tightening them. Make sure that there are no loose screws after tightening terminal screws to the specified torque of 0.43 to 0.58 N·m.
		Be sure to confirm the polarity for each terminal before wiring the terminal block and connectors.
	Power supply inputs	Wire the power supply inputs correctly. Incorrect wiring will result in damage to the internal circuits.
Operating environment	Ambient temperature	The ambient operating temperature for the product is -10 to 55°C (with no condensation or icing). To extend the service life of the product, install it in a location with an ambient temperature as low as possible. In locations exposed to high temperatures, if necessary, cool the products using a fan or other cooling method.
	Vibration and shock	Check whether the standards related to shock and vibration are satisfied at the installation environment. (Install the product in locations where the contactors will not be subject to vibration or shock.)
	Foreign particles	Install the product in a location that is not subject to liquid or foreign particles entering the product.

Revision History

A manual revision code appears as a suffix to the catalog number on the front cover of the manual.

Cat. No.	H174-E1-01
----------	-------------------

↑
Revision code

Revision code	Date	Revised content
01	December 2011	Original production

Conventions Used in This Manual

Model Notation

The E5CC-□□ and E5EC-□□ are given as the E5CC and E5EC when all of the models share functionality.

The following notation is used when specifying differences in functionality

	Event inputs	Communications	Remote SP Input	HB alarm and HS alarm	Transfer output
E5CC/E5EC-□-000	---	---	---	---	---
E5CC-□-001	2	---	---	1	---
E5CC-□-002	---	RS-485	---	1	---
E5CC-□-003	---	RS-485	---	2 (for 3-phase heaters)	---
E5CC/E5EC-□-004	2	RS-485	---	---	---
E5CC/E5EC-□-005	4	---	---	---	---
E5CC-□-006	2	---	---	---	Provided.
E5CC-□-007	2	---	Provided.	---	---
E5EC-□-008	2	RS-485	---	1	---
E5EC-□-009	2	RS-485	---	2 (for 3-phase heaters)	---
E5EC-□-010	4	---	---	1	---
E5EC-□-011	6	---	Provided.	1	Provided.
E5EC-□-012	4	RS-485	Provided.	1	Provided.
E5EC-□-013	6	---	Provided.	---	Provided.
E5EC-□-014	4	RS-485	Provided.	---	Provided.

Meanings of Abbreviations

The following abbreviations are used in parameter names, figures, and other descriptions. These abbreviations mean the following:

Symbol	Term
PV	Process value
SP	Set point
SV	Set value
AT	Auto-tuning
ST	Self-tuning
EU	Engineering unit*
LBA	Loop burnout alarm
HB	Heater burnout
HS	Heater short
RSP	Remote SP
LSP	Local SP

* "EU" stands for Engineering Unit. EU is used as the minimum unit for engineering units such as °C, m, and g. The size of the EU depends on the input type. For example, when the input temperature setting range is -200 to 1,300°C, 1 EU is 1°C, and when the input temperature setting range is -20.0 to 500.0°C, 1 EU is 0.1°C. For analog inputs, the size of the EU depends on the decimal point position of the scaling setting, and 1 EU is the minimum scaling unit.

How to Read Display Symbols

The following tables show the correspondence between the symbols displayed on the displays and alphabet characters.

<i>A</i>	<i>b</i>	<i>c</i>	<i>d</i>	<i>E</i>	<i>F</i>	<i>G</i>	<i>H</i>	<i>I</i>	<i>J</i>	<i>K</i>	<i>L</i>	<i>M</i>
A	B	C	D	E	F	G	H	I	J	K	L	M

<i>N</i>	<i>o</i>	<i>P</i>	<i>Q</i>	<i>R</i>	<i>S</i>	<i>T</i>	<i>U</i>	<i>V</i>	<i>W</i>	<i>X</i>	<i>Y</i>	<i>Z</i>
N	O	P	Q	R	S	T	U	V	W	X	Y	Z

How This Manual is Organized

Goal	Related sections	Contents
<ul style="list-style-type: none"> ● Learning about the appearance, features, functions, and model numbers of the E5CC/E5EC 	<i>Section 1 Introduction</i>	This section shows the appearance and describes the features, functions, and model numbers of the E5CC/E5EC.
<ul style="list-style-type: none"> ● Setting up the E5CC/E5EC 	<i>Section 2 Preparations</i>	This section describes the steps that are required before turning ON the power supply to the E5CC/E5EC (including installation, terminal usage, wiring, and isolation/insulation block diagram). It also describes how to use the Setup Tool ports.
<ul style="list-style-type: none"> ● Learning the basic procedures from turning ON the power supply to the E5CC/E5EC to starting actual operation 	<i>Section 3 Part Names and Basic Procedures</i>	This section describes the basic procedures from turning ON the power supply to the E5CC/E5EC to starting actual operation. It also gives the names of the parts of the E5CC/E5EC. This section serves as a basic tutorial for first-time users of the E5CC/E5EC.
<ul style="list-style-type: none"> ● Learning the basic operating methods for the E5CC/E5EC 	<i>Section 4 Basic Operation</i> <i>Section 6 Parameters</i>	<p>These sections describe the basic operating methods and provide specific examples of the following basic functions of the E5CC/E5EC.</p> <ul style="list-style-type: none"> • Moving between setting levels • Setting the input type • Selecting the temperature unit • Selecting between PID control and ON/OFF control • Setting the set point • Using ON/OFF control • Determining PID constants • Setting alarm outputs • Setting alarm hysteresis • Using heater burnout (HB) and heater short (HS) alarms • Customizing the displays

Goal	Related sections	Contents
<ul style="list-style-type: none"> ● Learning advanced operating methods for the E5CC/E5EC 	<i>Section 5 Advanced Operations</i> <i>Section 6 Parameters</i>	<p>These sections describe the following advanced operating methods to help you make the most of the E5CC/E5EC.</p> <ul style="list-style-type: none"> • Input shift • Scaling upper/lower limits for an analog input • Heating and cooling control • Event inputs • Multi-SP • Upper/lower limits for the set point • SP ramp • Protection • Displaying changed parameters • OR output of alarms • Alarm delays and loop burnout alarms • Manual control • Transfer output • Simple programming • Output limits, MV at stop, and MV at PV error • Extraction of square root • MV rate of change • Setting the Shift Key (PF Key) • PV/SV status display • Communications with a host device (e.g., a PLC) • Remote SP • Logic operations
<ul style="list-style-type: none"> ● Calibrating the E5CC/E5EC 	<i>Section 7 User Calibration</i>	<p>This section describes the procedures that you can use to calibrate the sensor or transfer output of the E5CC/E5EC.</p>
<ul style="list-style-type: none"> ● Learning the specifications and parameters of the E5CC/E5EC 	<i>Appendices</i>	<p>The appendices list the specifications and parameters of the E5CC/E5EC.</p>

Related Manuals

The following manual is also related to the E5CC/E5EC.

Manual name	Cat. No.	Contents
<ul style="list-style-type: none"> ● E5CC/E5EC Digital Temperature Controllers Communications Manual 	H175	<p>This manual describes the command text and communications procedures to use the CompoWay/F and Modbus-RTU protocols for serial communications between the E5CC/E5EC and a host device (e.g., a PLC).</p>

Sections in this Manual

1	Introduction	1
2	Preparations	2
3	Part Names and Basic Procedures	3
4	Basic Operation	4
5	Advanced Operations	5
6	Parameters	6
7	User Calibration	7
A	Appendices	A
I	Index	I

CONTENTS

Preface	1
Read and Understand this Manual	2
Safety Precautions	5
Definition of Precautionary Information	1-5
Symbols	1-5
Precautions for Safe Use	8
Installation Precautions	10
Precautions for Operation	12
Preparations for Use	13
Revision History	14
Conventions Used in This Manual	15
Model Notation	1-15
Meanings of Abbreviations	1-15
How to Read Display Symbols	1-16
How This Manual is Organized	1-16
Related Manuals	1-17
Sections in this Manual	19

Section 1 Introduction

1-1 Appearance, Features, and Functions of the E5CC/E5EC	1-2
1-1-1 Appearance	1-2
1-1-2 Features	1-2
1-1-3 Main Functions	1-3
1-2 I/O Configuration and Model Number Legend	1-5
1-2-1 I/O Configuration	1-5
1-2-2 Model Number Legends	1-6

Section 2 Preparations

2-1 Installation	2-2
2-1-1 Dimensions (Unit: mm)	2-2
2-1-2 Panel Cutout (Unit: mm)	2-3
2-1-3 Mounting	2-5
2-2 Using the Terminals	2-7
2-2-1 E5CC Terminal Block Wiring Example	2-7
2-2-2 E5EC Terminal Block Wiring Example	2-11
2-2-3 Precautions when Wiring	2-16
2-2-4 Wiring	2-16
2-3 Insulation Block Diagrams	2-22
2-4 Using the Setup Tool Port	2-23
2-4-1 Procedure	2-23
2-4-2 Connection Method	2-23
2-4-3 Installing the Driver	2-26

Section 3 Part Names and Basic Procedures

3-1	Basic Application Flow	3-2
3-2	Power ON.....	3-3
3-3	Part Names, Part Functions, and Setting Levels	3-4
3-3-1	Part Names and Functions	3-4
3-3-2	Entering Numeric Values	3-7
3-3-3	Setting Levels	3-8
3-3-4	E5CC/E5EC Setting Levels	3-9
3-4	Procedures after Turning ON the Power Supply.....	3-13
3-4-1	Basic Flow of Operations.....	3-13
3-4-2	Basic Procedure	3-13

Section 4 Basic Operation

4-1	Moving between Setting Levels	4-3
4-1-1	Moving to the Initial Setting Level	4-3
4-1-2	Moving to the Adjustment Level.....	4-4
4-1-3	Moving to the Protect Level	4-4
4-1-4	Moving to the Advanced Function Setting Level.....	4-5
4-1-5	Moving to the Communications Setting Level.....	4-7
4-2	Initial Setting Examples	4-8
4-3	Setting the Input Type	4-10
4-3-1	Input Type	4-10
4-4	Selecting the Temperature Unit.....	4-12
4-4-1	Temperature Unit	4-12
4-5	Selecting PID Control or ON/OFF Control	4-13
4-6	Setting Output Specifications	4-14
4-6-1	Control Periods	4-14
4-6-2	Direct and Reverse Operation	4-14
4-6-3	Assigned Output Functions.....	4-15
4-6-4	Auxiliary Output Opening or Closing in Alarm	4-18
4-7	Setting the Set Point (SP)	4-19
4-7-1	Changing the SP.....	4-19
4-8	Using ON/OFF Control	4-20
4-8-1	ON/OFF Control.....	4-20
4-8-2	Settings.....	4-21
4-9	Determining PID Constants (AT, ST, Manual Setup).....	4-23
4-9-1	AT (Auto-tuning).....	4-23
4-9-2	ST (Self-tuning).....	4-25
4-9-3	Manual Setup.....	4-28
4-10	Alarm Outputs.....	4-30
4-10-1	Alarm Types.....	4-30
4-10-2	Alarm Values	4-34
4-11	Alarm Hysteresis	4-37
4-11-1	Standby Sequence	4-37
4-11-2	Alarm Latch	4-38
4-12	Using Heater Burnout (HB) and Heater Short (HS) Alarms	4-39
4-12-1	HB Alarm	4-39
4-12-2	HS Alarm	4-41
4-12-3	Installing Current Transformers (CT)	4-43
4-12-4	Calculating Detection Current Values	4-45
4-12-5	Application Examples	4-45

4-13 Customizing the PV/SP Display	4-49
4-13-1 PV/SP Display Selections	4-49

Section 5 Advanced Operations

5-1 Shifting Input Values	5-3
5-2 Setting Scaling Upper and Lower Limits for Analog Inputs	5-5
5-3 Executing Heating/Cooling Control	5-7
5-3-1 Heating/Cooling Control	5-7
5-4 Using Event Inputs	5-11
5-4-1 Event Input Settings	5-11
5-4-2 How to Use the Multi-SP Function	5-11
5-4-3 Operation Commands Other than Multi-SP	5-12
5-5 Setting the SP Upper and Lower Limit Values	5-15
5-5-1 Set Point Limiter	5-15
5-5-2 Setting	5-16
5-6 Using the SP Ramp Function to Limit the SP Change Rate	5-17
5-6-1 SP Ramp	5-17
5-7 Using the Key Protect Level	5-19
5-7-1 Protection	5-19
5-7-2 Entering the Password to Move to the Protect Level	5-20
5-8 Displaying Only Parameters That Have Been Changed	5-22
5-8-1 Displaying Changed Parameters	5-22
5-9 OR Output of Alarms	5-24
5-9-1 Integrated Alarm	5-24
5-10 Alarm Delays	5-26
5-10-1 Alarm Delays	5-26
5-11 Loop Burnout Alarm	5-28
5-11-1 Loop Burnout Alarm (LBA)	5-28
5-12 Performing Manual Control	5-31
5-12-1 Manual Operation	5-31
5-13 Using the Transfer Output	5-34
5-13-1 Transfer Output Function	5-34
5-14 Using the Simple Program Function	5-37
5-14-1 Simple Program Function	5-37
5-14-2 Operation at the Program End	5-39
5-14-3 Application Example Using a Simple Program	5-41
5-15 Output Adjustment Functions	5-42
5-15-1 Output Limits	5-42
5-15-2 MV at Stop	5-42
5-15-3 MV at PV Error	5-43
5-16 Using the Extraction of Square Root Parameter	5-44
5-16-1 Extraction of Square Roots	5-44
5-17 Setting the Width of MV Variation	5-46
5-17-1 MV Change Rate Limit	5-46
5-18 Setting the PF Key	5-48
5-18-1 PF Setting (Function Key)	5-48
5-19 Displaying PV/SV Status	5-51
5-19-1 PV and SV Status Display Functions	5-51
5-20 Communications with a Host Device (e.g., a PLC)	5-53
5-21 Using a Remote SP	5-55

5-22	Logic Operations	5-57
5-22-1	The Logic Operation Function (CX-Thermo)	5-57
5-22-2	Using Logic Operations	5-57

Section 6 Parameters

6-1	Conventions Used in this Section	6-2
6-2	Protect Level	6-3
6-3	Operation Level	6-7
6-4	Adjustment Level	6-17
6-5	Monitor/Setting Item Level	6-35
6-6	Manual Control Level	6-36
6-7	Initial Setting Level	6-38
6-8	Advanced Function Setting Level	6-54
6-9	Communications Setting Level	6-84

Section 7 User Calibration

7-1	User Calibration	7-2
7-2	Parameter Structure	7-3
7-3	Thermocouple Calibration	7-4
7-4	Resistance Thermometer Calibration	7-7
7-5	Calibrating Analog Input	7-9
7-6	Calibrating the Transfer Output	7-11
7-7	Checking Indication Accuracy	7-13

Section A Appendices

A-1	Specifications	A-2
A-1-1	Ratings.....	A-2
A-1-2	Characteristics	A-4
A-1-3	Rating and Characteristics of Options	A-5
A-1-4	Waterproof Packing	A-5
A-1-5	Setup Tool Port Cover for Front Panel	A-6
A-2	Current Transformer (CT)	A-7
A-2-1	Specifications.....	A-7
A-2-2	Dimensions (Unit: mm)	A-7
A-3	USB-Serial Conversion Cable and Conversion Cable	A-8
A-3-1	E58-CIFQ2 USB-Serial Conversion Cable	A-8
A-3-2	E58-CIFQ2-E Conversion Cable.....	A-9
A-4	Error Displays	A-10
A-5	Troubleshooting	A-13
A-6	Parameter Operation Lists	A-16
A-6-1	Operation Level.....	A-16
A-6-2	Adjustment Level	A-17
A-6-3	Initial Setting Level.....	A-18
A-6-4	Manual Control Level.....	A-21
A-6-5	Monitor/Setting Item Level	A-21
A-6-6	Advanced Function Setting Level	A-22

A-6-7	Protect Level	A-26
A-6-8	Communications Setting Level.....	A-26
A-6-9	Initialization According to Parameter Changes	A-27
A-7	Sensor Input Setting Range, Indication Range, Control Range.....	A-30
A-8	Setting Levels Diagram	A-31
A-9	Parameter Flow	A-32

Index

1

Introduction

1-1	Appearance, Features, and Functions of the E5CC/E5EC	1-2
1-1-1	Appearance	1-2
1-1-2	Features	1-2
1-1-3	Main Functions	1-3
1-2	I/O Configuration and Model Number Legend	1-5
1-2-1	I/O Configuration	1-5
1-2-2	Model Number Legends	1-6

1-1 Appearance, Features, and Functions of the E5CC/E5EC

1-1-1 Appearance

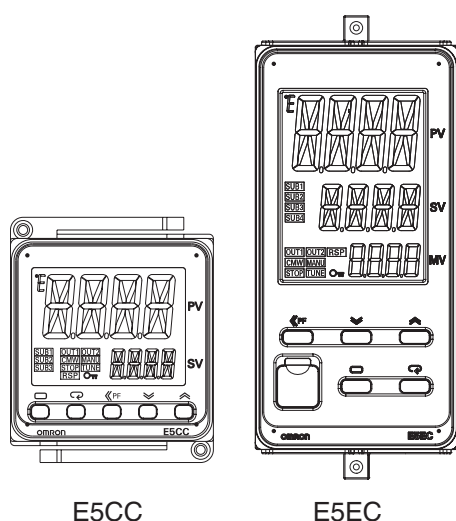

- A stylish design that gives a new look to control panels.
- Large display characters and white backlight for better visibility.
- A compact size to help downsize control panels.
- Much faster sampling and greater expandability than expected in this class of Controller.
- Even easier to use than previous models.

1-1-2 Features

This section compares the features of the E5CC/E5EC with the previous E5CN/E5EN Controllers.

High-speed Control Capability

Input sampling cycle: 50 ms
 Control period: 0.1 s and 0.2 s have been added.
 Integral/differential time unit: Setting in increments of 0.1 s has been added.

I/O Expandability

- Number of event inputs: Increased from 2 to 4 for the E5CC and from 4 to 6 for the E5EC.
- Number of auxiliary outputs: Increased from 2 to 3 for the E5CC and from 3 to 4 for the E5EC.
- Remote SP inputs: A remote SP input that treats the external analog signal at the set point (SP) has been added.

Universal Input Capability

Universal input: The input sensor can be selected freely from the following for any model of the E5CC or E5EC: Thermocouple, resistance thermometer, ES1B Infrared Temperature Sensor, current, and voltage.

Easier Numeric Inputs with a Digit Shift Key

Digit shift: When setting the SP or other parameters, you can use a Shift Key (assigned to the PF Key) to shift the digit that is being set to aid changing the set values.

Setup Tool Port on Front Panel of the E5EC

This port allows you to change or set parameters from the Setup Tool even when the Controller is installed in a panel.

1-1-3 Main Functions

This section introduces the main E5CC/E5EC functions. For details on particular functions and how to use them, refer to *Section 3 Part Names and Basic Procedures* and following sections.

● Input Sensor Types

You can connect the following sensors and signals to the universal input.

Thermocouple:	K, J, T, E, L, U, N, R, S, B, W, PLII
Resistance thermometer:	Pt100, JPt100
Infrared temperature sensor:	ES1B
	10 to 70°C, 60 to 120°C, 115 to 165°C, 140 to 260°C
Current input:	4 to 20 mA DC, 0 to 20 mA DC
Voltage input:	1 to 5 VDC, 0 to 5 V DC, 0 to 10 V DC

● Control Outputs

- A control output can be a relay, voltage (for driving SSR), or current output, depending on the model.

● Adjusting PID Constants

- You can easily set the optimum PID constants by performing AT (auto-tuning) with the limit cycle method or by performing ST (self-tuning) with the step response method.
- You can also add RT(robust tuning) to give priority to control stability.

● Alarms

Standard Alarms

- You can output an alarm when the deviation, process value, set point, or manipulated value reaches a specified value.
- You can also output alarms for the PV rate of change and for loop burnouts.
- If necessary, a more comprehensive alarm function can be achieved by setting a standby sequence, alarm hysteresis, auxiliary output close in alarm/open in alarm, alarm latch, alarm ON delay, and alarm OFF delay.

HB and HS Alarms

- With models with the optional HB and HS alarms, you can detect heater burnout and heater short alarms based on CT inputs.

Integrated Alarm

- You can output an integrated alarm if a standard alarm, HB alarm, or HS alarm turns ON.

● Event Inputs

- With any E5CC/E5EC model that supports event inputs, you can use external contact or non-contact inputs to achieve any of the following functions: Switching set points (Multi-SP No. Switch, 8 points max.), switching RUN/STOP, switching between automatic and manual operation, starting/resetting the program, inverting direct/reverse operation, switching the SP mode 100% AT execute/cancel, 40% AT execute/cancel, setting change enable/disable, communications write enable/disable, and canceling the alarm latch.

● **Communications Functions**

With any E5CC/E5EC model that supports communications, you can use communications via CompoWay/F^{*1} or Modbus^{*2}.

RS-485 Interface

- *1 CompoWay/F is an integrated general-purpose serial communications protocol developed by OMRON. It uses commands compliant with the well-established FINS, together with a consistent frame format on OMRON Programmable Controllers to facilitate communications between personal computers and components.
- *2 Modbus is a communications control method conforming to the RTU Mode of Modbus Protocol. Modbus is a registered trademark of Schneider Electric.

● **Transfer Output**

With any E5CC/E5EC model that supports a transfer output, you can output the set point, process value, manipulated variable, or other values as a 4 to 20-mA or 1 to 5-V transfer output.

● **Remote SP**

With any E5CC/E5EC model that supports remote SP input, you can set the set point with an analog input.

1-2 I/O Configuration and Model Number Legend

1-2-1 I/O Configuration

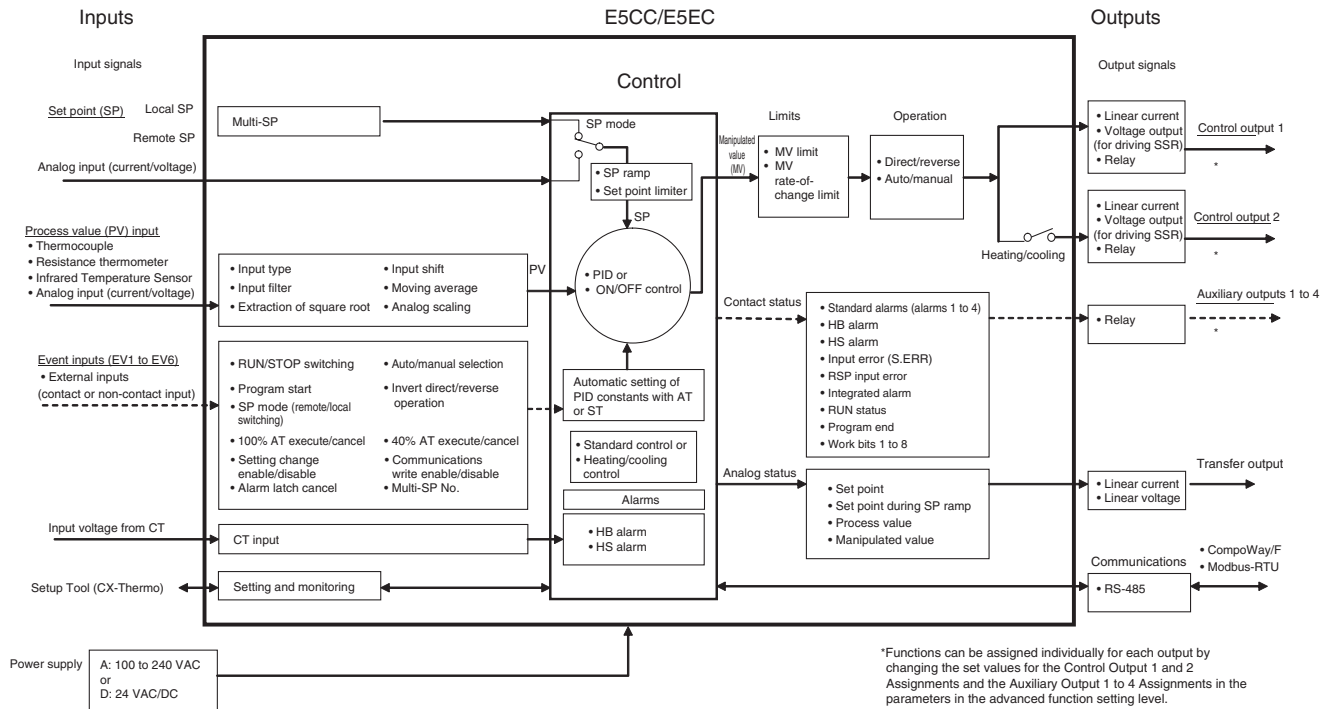

Note: Not all models support these functions. For details, refer to 1-2-2 Model Number Legends.

1-2-2 Model Number Legends

● E5CC

E5 C - -

(1) (2) (3) (4) (5) (6) (7)

(1)	(2)	(3)	(4)	(5)	(6)	(7)	Meaning				
Size	Control Outputs 1 and 2	No. of auxiliary outputs	Power supply voltage	Terminal type	Input type	Options					
C							48 × 48 mm				
							Control output 1		Control output 2		
	R	X					Relay output		None		
	Q	X					Voltage output (for driving SSR)		None		
*1	C	X					Linear current output		None		
	Q	Q					Voltage output (for driving SSR)		Voltage output (for driving SSR)		
	*2*3	0					None				
	*3	2					2				
		3					3				
		A					100 to 240 VAC				
		D					24 VAC/DC				
		S					Screw terminals				
		5					Screw terminals (with cover)				
		M					Universal input				
							Event inputs	Communications	Remote SP Input	HB alarm and HS alarm	Transfer output
							000	---	---	---	---
							001	2	---	1	---
						*3	002	---	RS-485	1	---
							003	---	RS-485	2 (for 3-phase heaters)	---
							004	2	RS-485	---	---
							005	4	---	---	---
							006	2	---	---	Provided.
							007	2	---	Provided.	---

*1 Options with HB and HS alarms (001 and 003) cannot be selected if a current output is selected for the control output. The control output cannot be used as a transfer output.

*2 If no auxiliary outputs (none) is selected, 000 (none) must be selected for the options.

*3 These cannot be selected if 5 (screw terminals with cover) is selected for the terminal type.

● E5EC

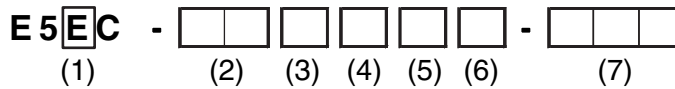

(1)	(2)	(3)	(4)	(5)	(6)	(7)	Meaning						
Size	Control Outputs 1 and 2	No. of auxiliary outputs	Power supply voltage	Terminal type	Input type	Options							
E							48 × 96 mm						
							Control output 1	Control output 2					
*1	R	X					Relay output	None					
*1	Q	X					Voltage output (for driving SSR)	None					
*2*1	C	X					Linear current output	None					
*1	Q	Q					Voltage output (for driving SSR)	Voltage output (for driving SSR)					
*1	Q	R					Voltage output (for driving SSR)	Relay output					
*1	R	R					Relay output	Relay output					
*2*1	C	C					Linear current output	Linear current output					
		*3	2				2						
			4				4						
			A				100 to 240 VAC						
			D				24 VAC/DC						
			S				Screw terminals						
			5				Screw terminals (with cover)						
			M				Universal input						
							Event inputs	Communications	Remote SP Input	HB alarm and HS alarm	Transfer output	For RX, QX, RR, QQ, or QR	For CX or CC
							000	---	---	---	---	Selectable	Selectable
							004	2	RS-485	---	---	---	Selectable
							005	4	---	---	---	---	Selectable
						*3	008	2	RS-485	---	1	Selectable	---
							009	2	RS-485	---	2 (for 3-phase heaters)	Selectable	---
							010	4	---	---	1	Selectable	---
							011	6	---	Provided.	1	Provided.	Selectable
						*3	012	4	RS-485	Provided.	1	Provided.	Selectable
							013	6	---	Provided.	---	Provided.	Selectable
							014	4	RS-485	Provided.	---	Provided.	Selectable

*1 The options that can be selected depend on the type of control output.
 *2 The control output cannot be used as a transfer output.
 *3 These cannot be selected if 5 (screw terminals with cover) is selected for the terminal type.

2

Preparations

2-1	Installation	2-2
2-1-1	Dimensions (Unit: mm)	2-2
2-1-2	Panel Cutout (Unit: mm)	2-3
2-1-3	Mounting	2-5
2-2	Using the Terminals	2-7
2-2-1	E5CC Terminal Block Wiring Example	2-7
2-2-2	E5EC Terminal Block Wiring Example	2-11
2-2-3	Precautions when Wiring	2-16
2-2-4	Wiring	2-16
2-3	Insulation Block Diagrams	2-22
2-4	Using the Setup Tool Port	2-23
2-4-1	Procedure	2-23
2-4-2	Connection Method	2-23
2-4-3	Installing the Driver	2-26

2-1 Installation

2-1-1 Dimensions (Unit: mm)

● E5CC

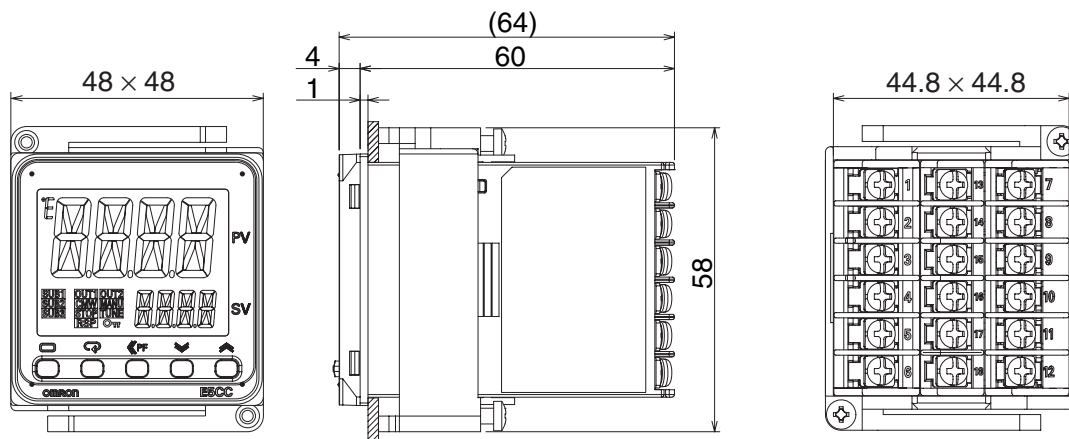

● E5EC

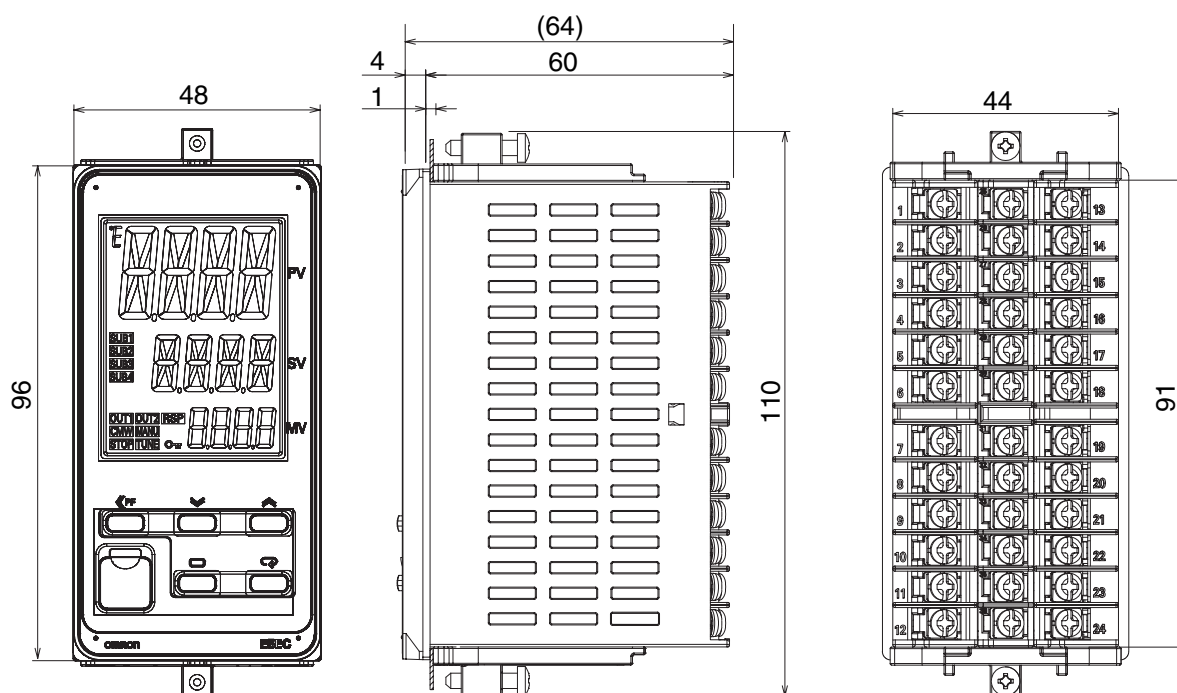

2-1-2 Panel Cutout (Unit: mm)

● E5CC

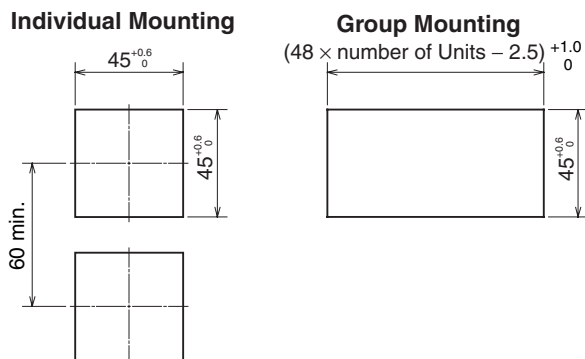

- Waterproofing is not possible when group mounting several Controllers.
- The recommended panel thickness is 1 to 5 mm for the E5CC.
- Controllers must not be closely mounted vertically. (Observe the recommended mounting space limits.)
- When group mounting several Controllers, ensure that the surrounding temperature does not exceed the ambient operating temperature listed in the specifications.

● E5EC

Individual Mounting

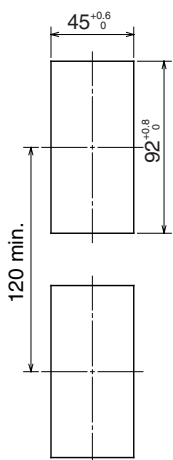

Group Mounting*

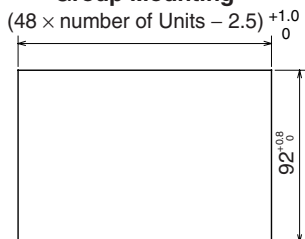

- Waterproofing is not possible when group mounting several Controllers.
- The recommended panel thickness is 1 to 8 mm for the E5EC.
- Controllers must not be closely mounted vertically. (Observe the recommended mounting space limits.)
- When group mounting several Controllers, ensure that the surrounding temperature does not exceed the ambient operating temperature listed in the specifications.

* For E5EC models with two control outputs (QQ, QR, RR, or CC) and 011, 012, 013, or 014 options (shown below), the ambient temperature for group mounting must be 45°C max.

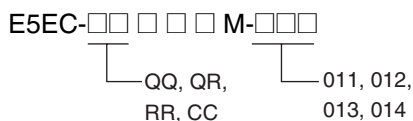

To mount these models at an ambient temperature of 55°C, install them at the following intervals.

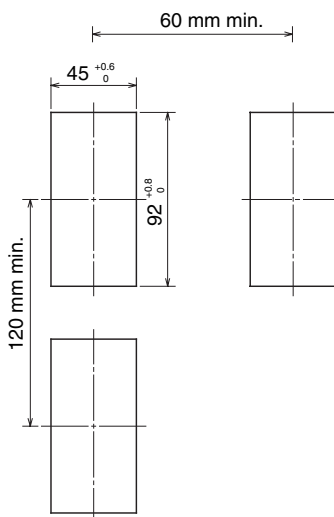

2-1-3 Mounting

● E5CC

There are two models of Terminal Covers that you can use with the E5CC.

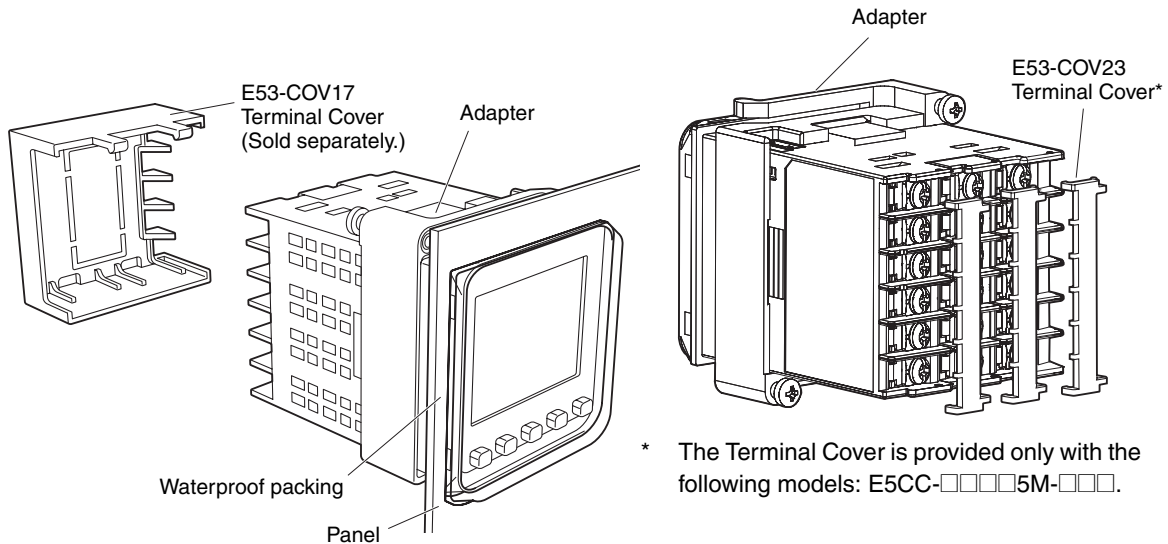

* The Terminal Cover is provided only with the following models: E5CC-□□□□5M-□□□.

Mounting to the Panel

- (1) For waterproof mounting, waterproof packing must be installed on the Controller. Waterproofing is not possible when group mounting several Controllers. Waterproof packing is not necessary when there is no need for the waterproofing function.
- (2) Insert the E5CC into the mounting hole in the panel.
- (3) Push the adapter from the terminals up to the panel, and temporarily fasten the E5CC.
- (4) Tighten the two fastening screws on the adapter. Alternately tighten the two screws little by little to maintain a balance. Tighten the screws to a torque of 0.29 to 0.39 N·m.

Mounting the Terminal Cover

Slightly bend the E53-COV23 Terminal Cover to attach it to the terminal block as shown in the following diagram. The Terminal Cover cannot be attached in the opposite direction. Or, you can use the E53-COV17 Terminal Cover. Make sure that the "UP" mark is facing up, and then attach the E53-COV17 Terminal Cover to the holes on the top and bottom of the Digital Controller.

● E53-COV17

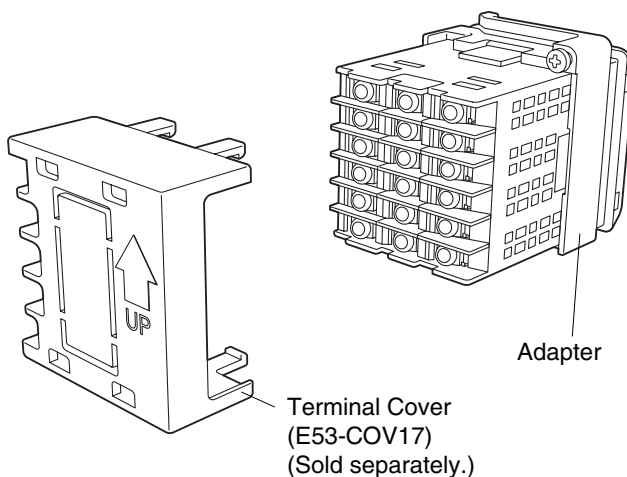

● E53-COV23

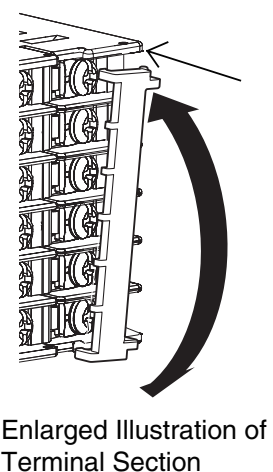

● E5EC

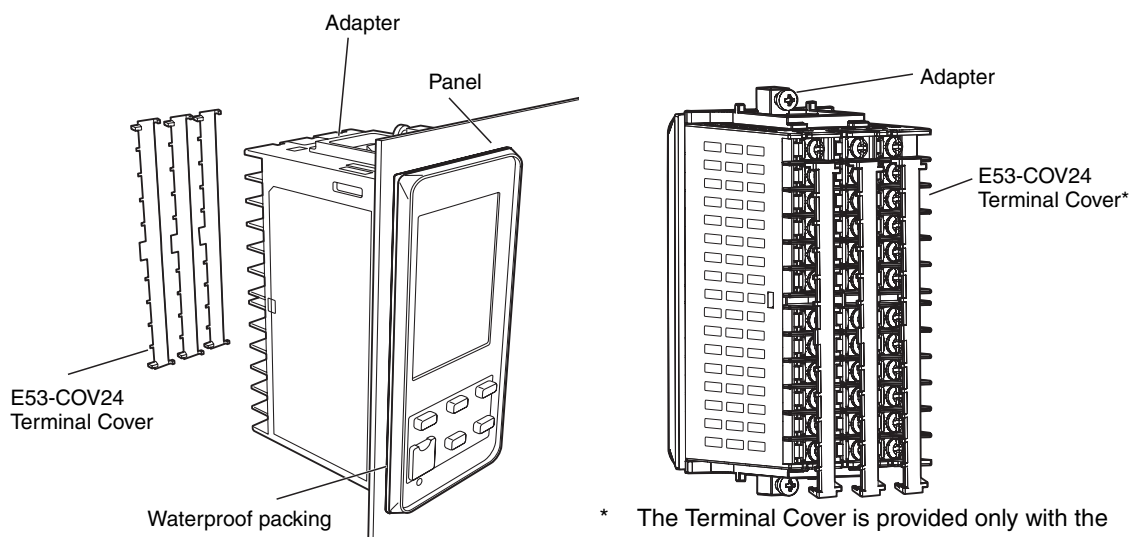

* The Terminal Cover is provided only with the following models: E5EC-□□□□5M-□□□.

Mounting to the Panel

- (1) For waterproof mounting, waterproof packing must be installed on the Controller. Waterproofing is not possible when group mounting several Controllers. Waterproof packing is not necessary when there is no need for the waterproofing function.
- (2) Insert the E5EC into the mounting hole in the panel.
- (3) Push the adapter from the terminals up to the panel, and temporarily fasten the E5EC.
- (4) Tighten the two fastening screws on the adapter. Alternately tighten the two screws little by little to maintain a balance. Tighten the screws to a torque of 0.29 to 0.39 N·m.

Mounting the Terminal Cover

Slightly bend the E53-COV24 Terminal Cover to attach it to the terminal block as shown in the following diagram. The Terminal Cover cannot be attached in the opposite direction.

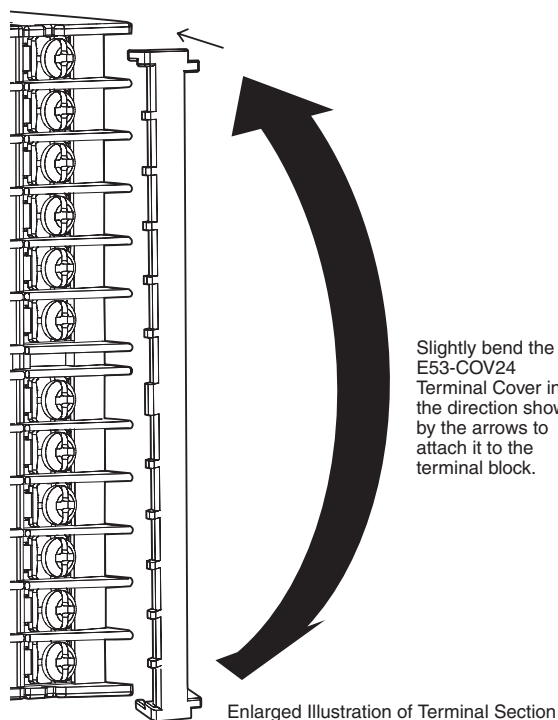

Slightly bend the E53-COV24 Terminal Cover in the direction shown by the arrows to attach it to the terminal block.

2-2 Using the Terminals

The terminal arrangements of the E5CC/E5EC are described in this section.

2-2-1 E5CC Terminal Block Wiring Example

● Terminal Arrangement

The terminals block of the E5CC is divided into five types of terminals: control outputs 1 and 2, sensor input, auxiliary outputs, input power supply, and options.

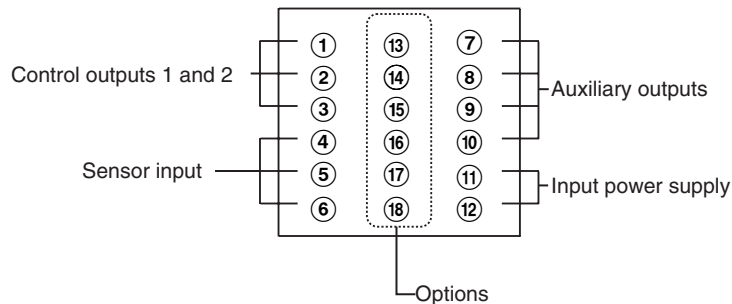

Precautions for Correct Use

When you purchase the Digital Controller, it will be set for a K thermocouple (input type = 5) by default. If a different sensor is used, an input error (*5.ERR*) will occur. Check the setting of the Input Type parameter.

Control Outputs 1 and 2

● Model Numbers

The specifications for control outputs 1 and 2 are given in the following location in the model number.

E5CC-□□ □ □ □ M-□□□□

└── Control outputs 1 and 2

Code	Output type	Specification
RX	1 relay output	250 VAC, 3 A (resistive load)
QX	1 voltage output (for driving SSR)	12 VDC, 21 mA
CX	1 current output	4 to 20 mA DC or 0 to 20 mA DC with load of 500 Ω max.
QQ	2 voltage outputs (for driving SSRs)	12 VDC, 21 mA

● **Terminal Details**

Do not connect anything to the terminals that are shaded gray.

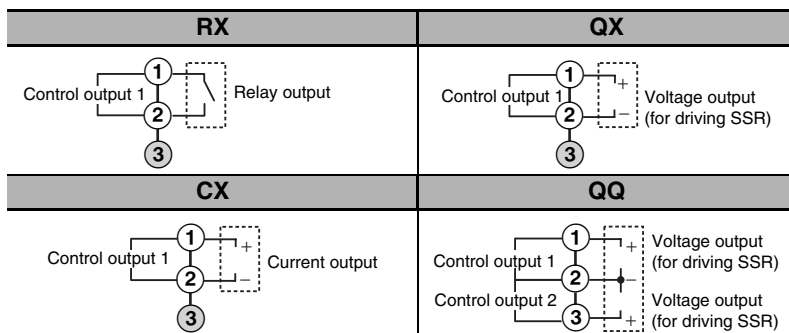

Sensor Input

● **Model Numbers**

All E5CC models have universal sensor inputs, so the code in the model number is always "M."



● **Terminal Details**

Do not connect anything to the terminals that are shaded gray.

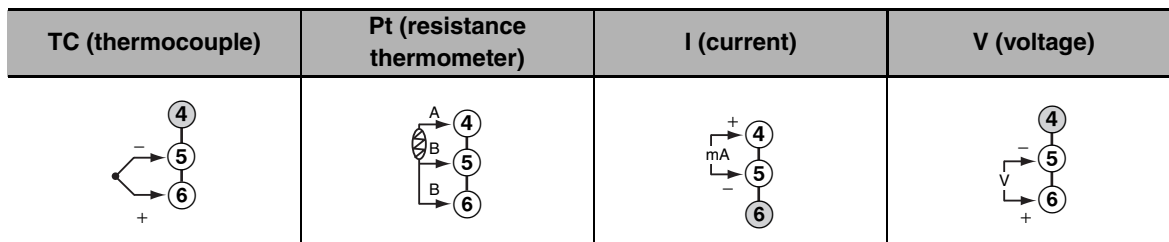

Precautions for Correct Use

When complying with EMC standards, the line connecting the sensor must be 30 m or less. If the cable length exceeds 30 m, compliance with EMC standards will not be possible.

Auxiliary Outputs

● Model Numbers

The number of auxiliary outputs on the E5CC is given in the following location in the model number.

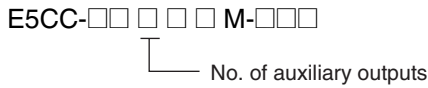

Code	Auxiliary outputs	Specification
0*	None	None
2*	Model with 2 auxiliary outputs	SPST-NO, 250 VAC, 3 A
3	Model with 3 auxiliary outputs	SPST-NO, 250 VAC, 2 A

* These cannot be selected if 5 (screw terminals with cover) is selected for the terminal type.

● Terminal Details

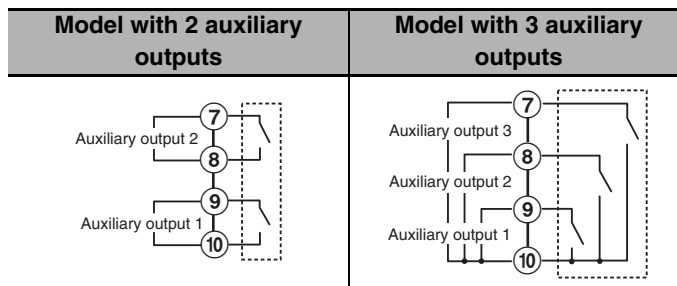

Input Power Supply

● Model Numbers

The input power supply specification of the E5CC is given in the following location in the model number.

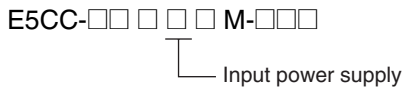

Code	Specification	Power consumption
A	100 to 240 VAC, 50/60 Hz	Option number 000: 5.2 VA max. Other option numbers: 6.5 VA max.
D	24 VAC, 50/60 Hz 24 VDC (no polarity)	Option number 000: 3.1 VA max./1.6 W max. Other option numbers: 4.1 VA max./2.3 W max.

● Terminal Details

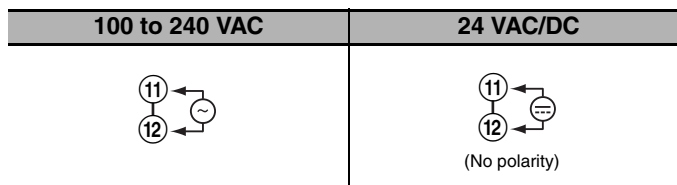

Options

● Model Numbers

The options specification of the E5CC is given in the following location in the model number.

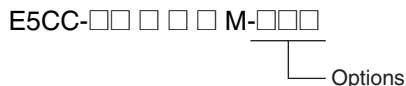

Code	Specification	Remarks
000	None	
001	Event inputs 1 and 2, and CT1	
002*	Communications (RS-485) and CT1	The communications protocol is CompoWay/F or Modbus-RTU.
003	Communications (RS-485), CT1, and CT2	The communications protocol is CompoWay/F or Modbus-RTU.
004	Communications (RS-485), and event inputs 3 and 4	The communications protocol is CompoWay/F or Modbus-RTU.
005	Event inputs 1 to 4	
006	Event inputs 1 and 2, and transfer output	Transfer output: Current: 4 to 20 mA DC Voltage: 1 to 5 VDC
007	Event inputs 1 and 2, and remote SP input	Remote SP input: Current: 4 to 20 or 0 to 20 mA DC Voltage: 1 to 5, 0 to 5, or 0 to 10 VDC

* These cannot be selected if 5 (screw terminals with cover) is selected for the terminal type.

● Terminal Details

Do not connect anything to the terminals that are shaded gray.

001	002	003
004	005	006
007		

2-2-2 E5EC Terminal Block Wiring Example

● Terminal Arrangement

The terminals block of the E5EC is divided into five types of terminals: control outputs 1 and 2, sensor input, auxiliary outputs, input power supply, and options.

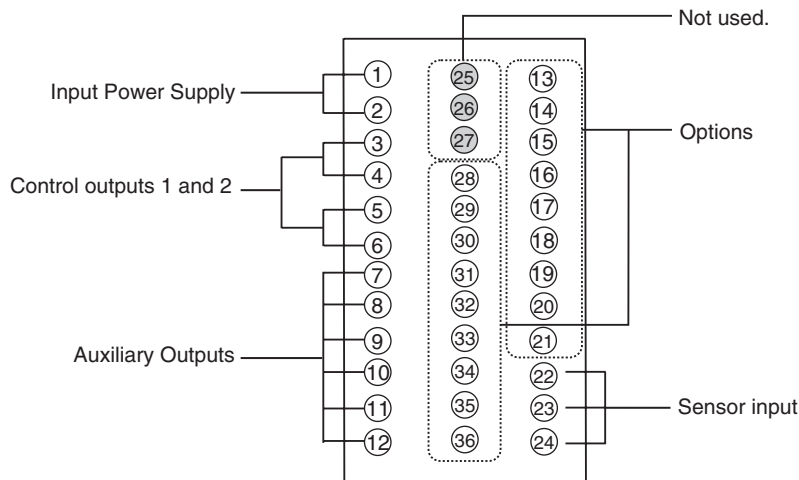

Precautions for Correct Use

- When you purchase the Digital Controller, it will be set for a K thermocouple (input type = 5). If a different sensor is used, an input error (*5.ERR*) will occur. Check the setting of the Input Type parameter.

Control Outputs 1 and 2

● Model Numbers

The specifications for control outputs 1 and 2 are given in the following location in the model number.

E5EC-□□ □ □ □ M-□□□□

Control outputs 1 and 2

Code	Output type	Specification
RX	1 relay output	250 VAC, 5 A (resistive load)
QX	1 voltage output (for driving SSR)	12 VDC, 40 mA
CX	1 current output	4 to 20 mA DC or 0 to 20 mA DC with load of 500 Ω max.
QQ	2 voltage outputs (for driving SSRs)	12 VDC, 21 mA
QR	1 voltage output (for driving SSR) and 1 relay output	12 VDC, 21 mA for voltage output 250 VAC, 5 A (resistive load) for relay output
RR	2 relay outputs	250 VAC, 5 A (resistive load)
CC	2 current outputs	4 to 20 mA DC or 0 to 20 mA DC with load of 500 Ω max.

● **Terminal Details**

Do not connect anything to the terminals that are shaded gray.

RX	QX	CX
QQ	QR	RR
CC		

Sensor Input

● **Model Numbers**

All E5EC models have universal sensor inputs, so the code in the model number is always "M."



● **Terminal Details**

Do not connect anything to the terminals that are shaded gray.

TC (thermocouple)	Pt (resistance thermometer)	I (current)	V (voltage)



Precautions for Correct Use

When complying with EMC standards, the line connecting the sensor must be 30 m or less. If the cable length exceeds 30 m, compliance with EMC standards will not be possible.

Auxiliary Outputs

● Model Numbers

The number of auxiliary outputs on the E5EC is given in the following location in the model number.

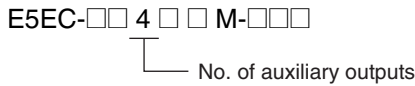

Code	Auxiliary outputs	Specification
2*	Model with 2 auxiliary outputs	SPST-NO, 250 VAC, 3 A
4	Model with 4 auxiliary outputs	SPST-NO, 250 VAC, 2 A

* These cannot be selected if 5 (screw terminals with cover) is selected for the terminal type.

● Terminal Details

Do not connect anything to the terminals that are shaded gray.

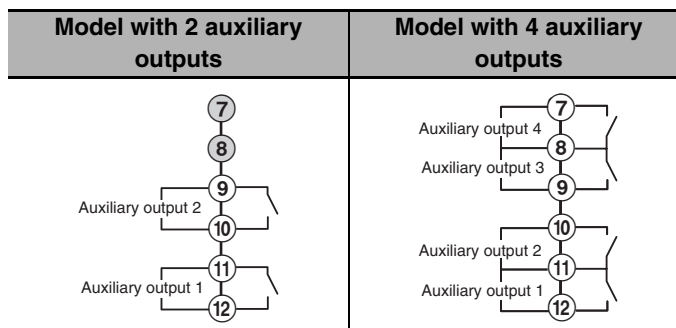

Input Power Supply

● Model Numbers

The input power supply specification of the E5EC is given in the following location in the model number.

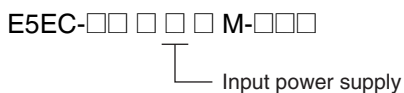

The codes that are given in the following table show the specification.

Code	Specification	Power consumption
A	100 to 240 VAC (50/60 Hz)	Option number 000: 6.6 VA max. Other option numbers: 8.3 VA max.
D	24 VAC, 50/60 Hz 24 VDC (no polarity)	Option number 000: 4.1 VA max./2.3 W max. Other option numbers: 5.5 VA max./3.2 W max.

● Terminal Details

Details on the input power supply terminals are shown below.

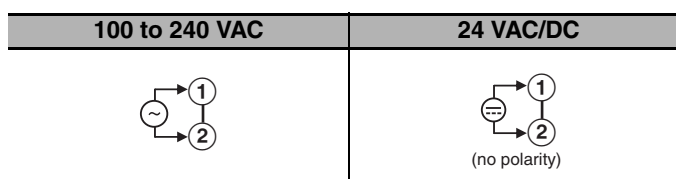

Options

● Model Numbers

The options specification of the E5EC is given in the following location in the model number.

E5EC-□□ □ □ □ M-□□□
└─ Options

Code	Specification	Remarks
000	None	
004	Communications (RS-485), and event inputs 1 and 2	The communications protocol is CompoWay/F or Modbus-RTU.
005	Event inputs 1 to 4	
008*	Communications (RS-485), event inputs 1 and 2, and CT1	The communications protocol is CompoWay/F or Modbus-RTU.
009	Communications (RS-485), event inputs 1 and 2, CT1, and CT2	The communications protocol is CompoWay/F or Modbus-RTU.
010	Event inputs 1 to 4, and CT1	
011	Event inputs 1 to 6, CT1, transfer output, and remote SP input	Transfer output: Current: 4 to 20 mA DC Voltage: 1 to 5 VDC Remote SP input: Current: 4 to 20 or 0 to 20 mA DC Voltage: 1 to 5, 0 to 5, or 0 to 10 VDC
012*	Communications (RS-485), event inputs 1, 2, 5, and 6, CT1, transfer output, and remote SP input	The communications protocol is CompoWay/F or Modbus-RTU. Transfer output: Current: 4 to 20 mA DC Voltage: 1 to 5 VDC Remote SP input: Current: 4 to 20 or 0 to 20 mA DC Voltage: 1 to 5, 0 to 5, or 0 to 10 VDC
013	Event inputs 1 to 6, transfer output, and remote SP input	Transfer output: Current: 4 to 20 mA DC Voltage: 1 to 5 VDC Remote SP input: Current: 4 to 20 or 0 to 20 mA DC Voltage: 1 to 5, 0 to 5, or 0 to 10 VDC
014	Communications (RS-485), event inputs 1, 2, 5, and 6, transfer output, and remote SP input	The communications protocol is CompoWay/F or Modbus-RTU. Transfer output: Current: 4 to 20 mA DC Voltage: 1 to 5 VDC Remote SP input: Current: 4 to 20 or 0 to 20 mA DC Voltage: 1 to 5, 0 to 5, or 0 to 10 VDC

* These cannot be selected if 5 (screw terminals with cover) is selected for the terminal type.

● Terminal Details

Do not connect anything to the terminals that are shaded gray.

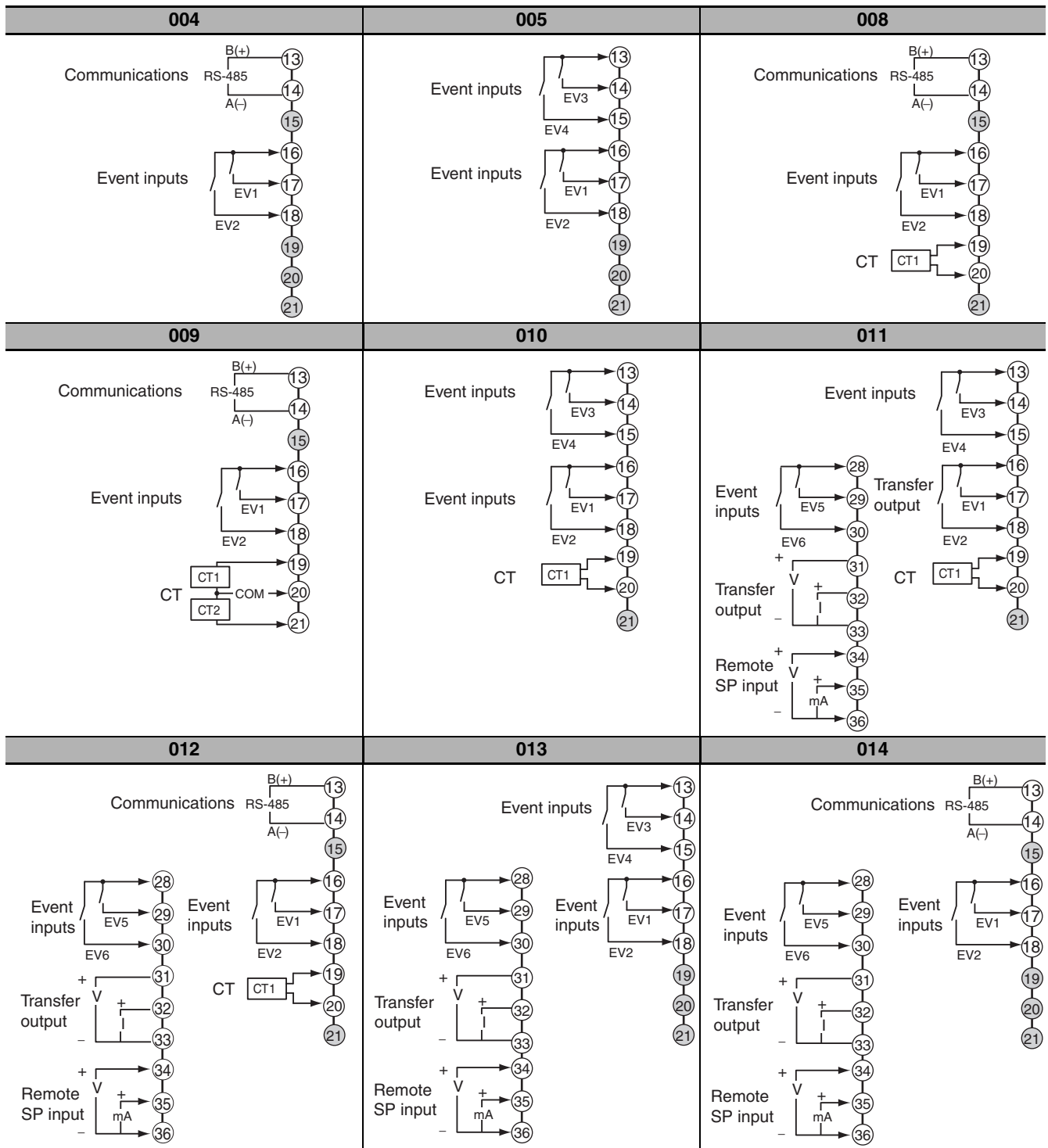

2-2-3 Precautions when Wiring

- Separate input leads and power lines in order to prevent external noise.
- Use a shielded, AWG24 to AWG18 (cross-sectional area of 0.205 to 0.823 mm²) twisted-pair cable. The stripping length is 6 to 8 mm.
- Use crimp terminals when wiring the terminals.
- Use the suitable wiring material and crimp tools for crimp terminals.
- Tighten the terminal screws to a torque of 0.43 to 0.58 N·m.
- Use the following types of crimp terminals for M3.0 screws.



2-2-4 Wiring

In the connection diagrams, the left side of the terminal numbers represents the inside of the Controller and the right side represents the outside.

● Power Supply Power Consumption

Input Power Supply	E5CC		E5EC	
	Options No.: 000	Options No.: Not 000	Options No.: 000	Options No.: Not 000
100 to 240 VAC, 50/60 Hz	5.2 VA max.	6.5 VA max.	6.6 VA max.	8.3 VA max.
24 VAC, 50/60 Hz	3.1 VA max.	4.1 VA max.	4.1 VA max.	5.5 VA max.
24 VDC (no polarity)	1.6 W max.	2.3 W max.	2.3 W max.	3.2 W max.

- These models have reinforced insulation between the input power supply, the relay outputs, and other terminals.

● Inputs

Refer to 2-2-1 *E5CC Terminal Block Wiring Example* or 2-2-2 *E5EC Terminal Block Wiring Example* for the terminal arrangement. When extending the thermocouple lead wires, be sure to use compensating wires that match the thermocouple type. When extending the lead wires of a resistance thermometer, be sure to use wires that have low resistance and keep the resistance of the three lead wires the same.

● **Control Outputs 1 and 2**

The following diagrams show the applicable outputs and their internal equivalent circuits.

E5CC

RX (relay output)	QX (voltage output (for driving SSR))	CX (current output)	QQ (2 voltage outputs (for driving SSRs))

Output type		Specification
RX	Relay output	SPST-NO, 250 VAC, 3 A (resistive load), Electrical durability: 100,000 operations
QX	Voltage output (for driving SSR)	PNP, 12 VDC \pm 20%, 21 mA (with short-circuit protection)
CX	Current output	4 to 20 or 0 to 20 mA DC, Load: 500 Ω max., Resolution: Approx. 10,000
QQ*	2 voltage outputs (for driving SSRs)	PNP, 12 VDC \pm 20%, 21 mA (with short-circuit protection)

* Control outputs 1 and 2 are not isolated on models with a QQ output type specification (2 voltage outputs (for driving SSRs)).

E5EC

RX (relay output)	QX (voltage output (for driving SSR))	CX (current output)	
RR (2 relay outputs)	QQ (2 voltage outputs (for driving SSRs))	QR (voltage output (for driving SSR) and relay output)	CC (2 current outputs)

Output type		Specification
RX	Relay output	SPST-NO, 250 VAC, 5 A (resistive load), Electrical durability: 100,000 operations
QX	Voltage output (for driving SSR)	PNP, 12 VDC \pm 20%, 40 mA (with short-circuit protection)
CX	Current output	4 to 20 or 0 to 20 mA DC, Load: 500 Ω max., Resolution: Approx. 10,000
RR	2 relay outputs	SPST-NO, 250 VAC, 5 A (resistive load), Electrical durability: 100,000 operations
QQ*	2 voltage outputs (for driving SSRs)	PNP, 12 VDC \pm 20%, 21 mA (with short-circuit protection)
QR	Voltage output (for driving SSRs) (control output 1)	PNP, 12 VDC \pm 20%, 21 mA (with short-circuit protection)
	Relay output (control output 2)	SPST-NO, 250 VAC, 5 A (resistive load), Electrical durability: 100,000 operations
CC	2 current outputs	4 to 20 or 0 to 20 mA DC, Load: 500 Ω max., Resolution: Approx. 10,000

* Control outputs 1 and 2 are not isolated on models with a QQ output type specification (2 voltage outputs (for driving SSRs)).

● **Auxiliary Outputs 1 to 4**

When heating/cooling control is used on the E5CC, auxiliary output 2 is the control output for cooling. When heating/cooling control is used on the E5EC, auxiliary output 4 is the control output for cooling unless the Controller has only two auxiliary outputs, in which case auxiliary output 2 is the control output for cooling.

● **Event Inputs**

E5CC/E5EC models with an option number of 001 or 004 to 014 have event inputs.

E5CC

Contact inputs	Non-contact inputs
Option number: 001, 006, or 007 	
Option number: 004 	
Option number: 005 	

E5EC

Contact inputs	Non-contact inputs
Option number: 004, 008 or 009 	
Option number: 005 or 010 	
Option number: 011 or 013 	
Option number: 012 or 014 	

- Use event inputs under the following conditions:
- The outflow current is approximately 7 mA.

Contact input ON: 1 k Ω max., OFF: 100 k Ω min.

No-contact input ON: Residual voltage of 1.5 V max.; OFF: Leakage current of 0.1 mA max.

● CT Inputs

E5CC/E5EC models with an option number of 001 to 003 or 008 to 012 have one or two CT inputs.

● **Transfer Output**

E5CC/E5EC models with an option number of 006 or 011 to 014 have a transfer output.

E5CC

Option number: 006

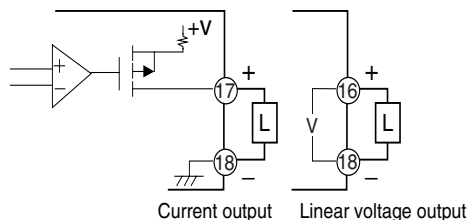

E5EC

Option number: 011, 012, 013, or 014

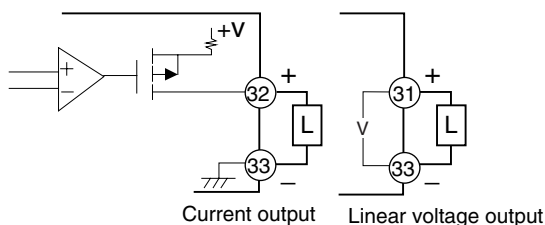

Output type	Specification
Current output	4 to 20 mA DC, Load: 500 Ω max., Resolution: 10,000
Linear voltage output	1 to 5 VDC, Load: 1 kΩ min., Resolution: 10,000

● **Remote SP Input**

E5CC/E5EC models with an option number of 007 or 011 to 014 have a remote SP input.

Input type	Specification
Current input	4 to 20 or 0 to 20 mA DC with input impedance of 150 Ω max.
Linear voltage input	1 to 5, 0 to 5, or 0 to 10 VDC with input impedance of 1 MΩ min.

The remote SP input circuit is not electrically isolated from the internal circuits. Therefore, when using a grounded sensor input, do not connect the remote SP input terminals to ground. (If the remote SP input terminals are connected to ground, errors will occur in the measured temperature as a result of leakage current.)

● Communications

RS-485

E5CC/E5EC models with an option number of 002, 003, 004, 008, 009, 012, or 014 support communications. Connect the communications cable to terminals 13 and 14 to use communications with the E5CC/E5EC.

Communications Unit Connection Diagram

● E5CC/E5EC

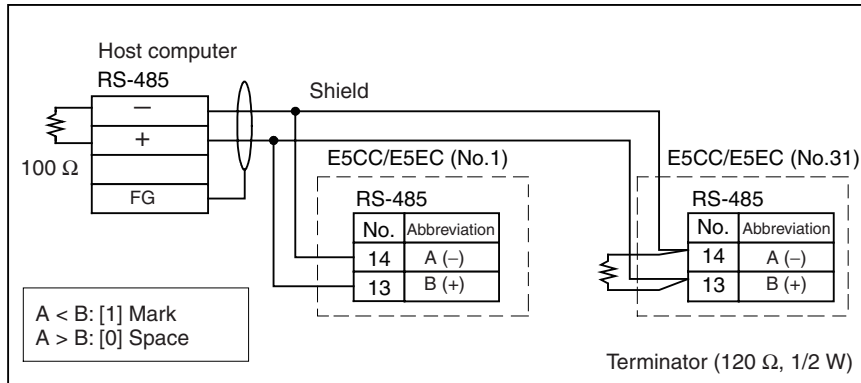

- The RS-485 connection can be either one-to-one or one-to-N. A maximum of 32 Units (including the host computer) can be connected in one-to-N systems. The maximum total cable length is 500 m. Use a shielded, AWG24 to AWG18 (cross-sectional area of 0.205 to 0.823 mm²) twisted-pair cable.

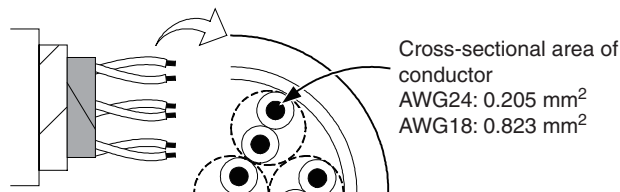

2-3 Insulation Block Diagrams

The insulation block diagrams for the E5CC/E5EC are provided in this section.

● Models with 2 Auxiliary Outputs

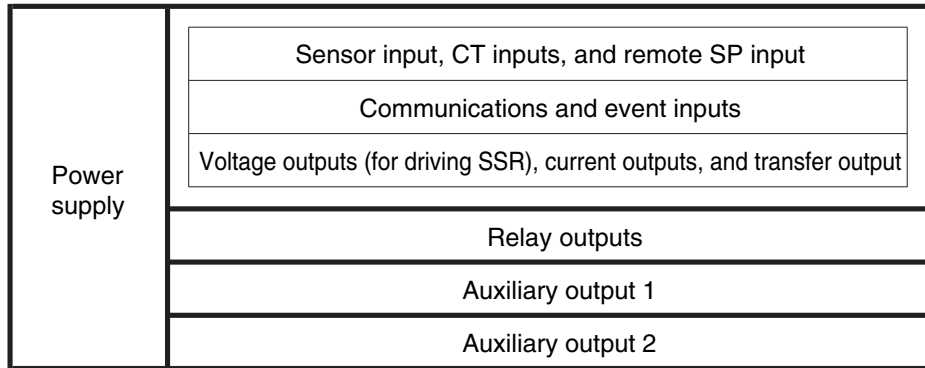



 : Reinforced insulation

 : Functional insulation

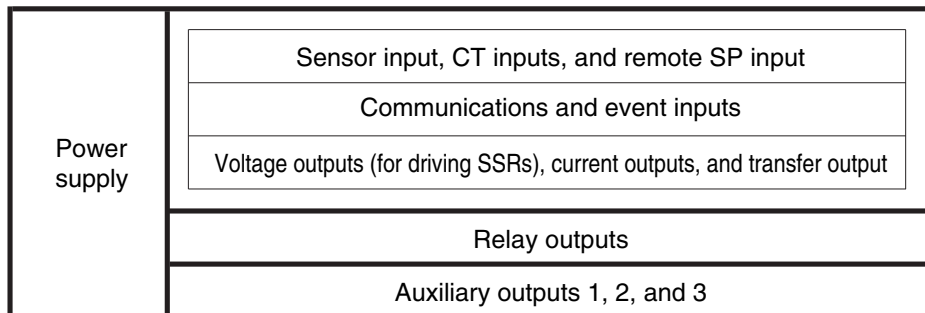
● Model with 3 Auxiliary Outputs



 : Reinforced insulation

 : Functional insulation

● Models with 4 Auxiliary Outputs

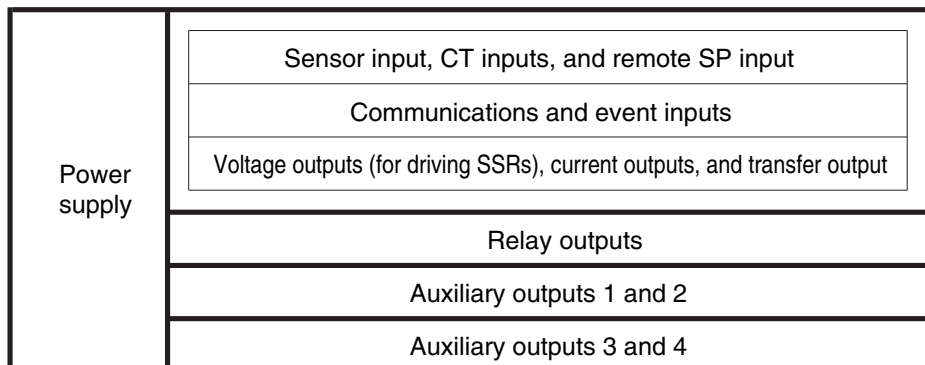

 : Reinforced insulation

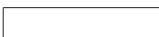
 : Functional insulation

2-4 Using the Setup Tool Port

Use the Setup Tool ports to connect the computer to the Digital Controller when using CX-Thermo version 4.4 or higher (EST2-2C-MV4 or later) or other Support Software.

The E58-CIFQ2 USB-Serial Conversion Cable*¹ is required for the connection. For information on the models that can be used with CX-Thermo, contact your OMRON sales representative.

*1 The E58-CIFQ2-E is required to connect to the Setup Tool port on the front panel of the E5EC.

2-4-1 Procedure

When the USB-Serial Conversion Cable is connected to the Digital Controller, the following operations are possible even if the power supply to the Digital Controller is not turned ON.

- Setting up the Digital Controller from a computer (Special software is required.)
- Changing settings by using key operations on the Digital Controller
- Displaying the current temperature on the Digital Controller

The control outputs, alarm outputs, transfer output, event inputs, and external communications for the Digital Controller will not operate unless the power supply to the Digital Controller is turned ON.

2-4-2 Connection Method

Use the E58-CIFQ2 USB-Serial Conversion Cable to connect the E5CC/E5EC to the computer. The USB-Serial Conversion Cable is used to communicate with a USB port on a computer as a virtual COM port.

E5CC

● Setup Tool Port and Connecting Cable

The location of the Setup Tool port on the E5CC and the required cable are shown below.

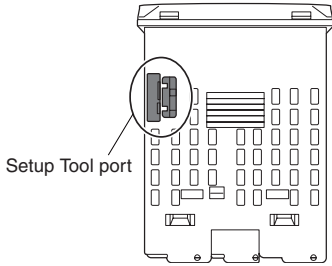
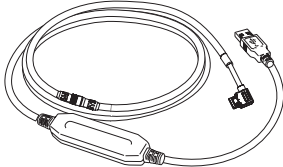
Setup Tool port	Connecting cable
<p data-bbox="368 1373 751 1402">• Top panel on the Digital Controller</p> 	<p data-bbox="1034 1402 1385 1424">E58-CIFQ2 USB-Serial Conversion Cable</p> 

● **Connection Procedure**

1 Connect the serial connector on the USB-Serial Conversion Cable to the Setup Tool port on the top panel of the Digital Controller.

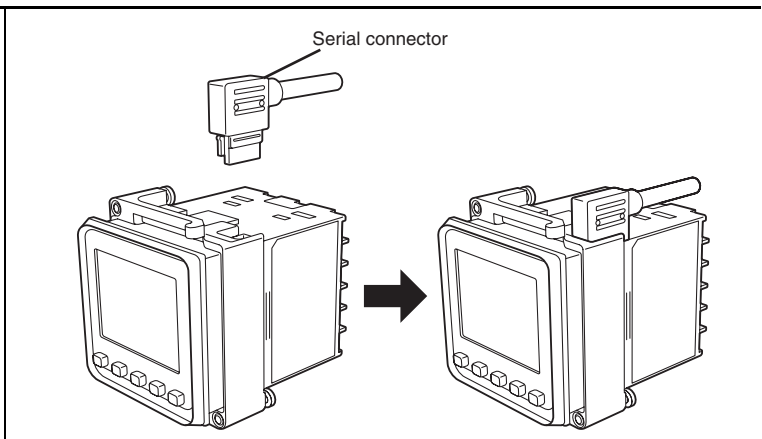

E5EC

● **Setup Tool Ports and Connecting Cables**

The locations of the Setup Tool ports on the E5EC and the required cables are shown below. There are Setup Tool ports on both the top panel and front panel of the Digital Controller.

Setup Tool ports		Connecting cables	
<ul style="list-style-type: none"> • Top panel on the Digital Controller 	<ul style="list-style-type: none"> • Front panel on the Digital Controller 	<p>E58-CIFQ2 USB-Serial Conversion Cable</p>	<p>E58-CIFQ2-E Conversion Cable*</p>

* This Cable is required only to connect to the front-panel Setup Tool port.

● **Connection Procedure**

- Top-panel Port

1 Connect the serial connector to the Setup Tool port on the top panel of the Digital Controller.

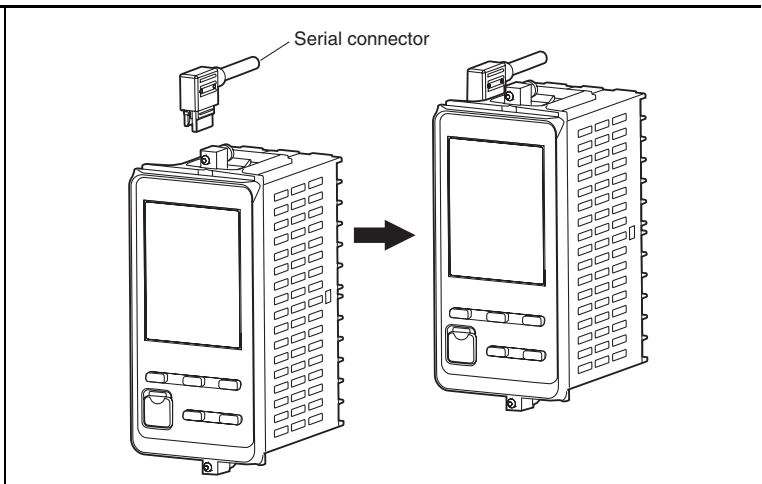

- Front-panel Port

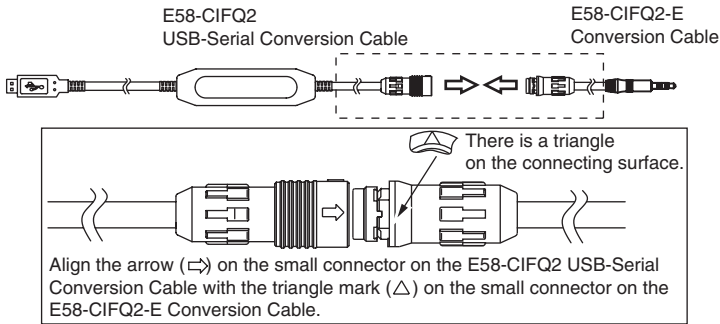
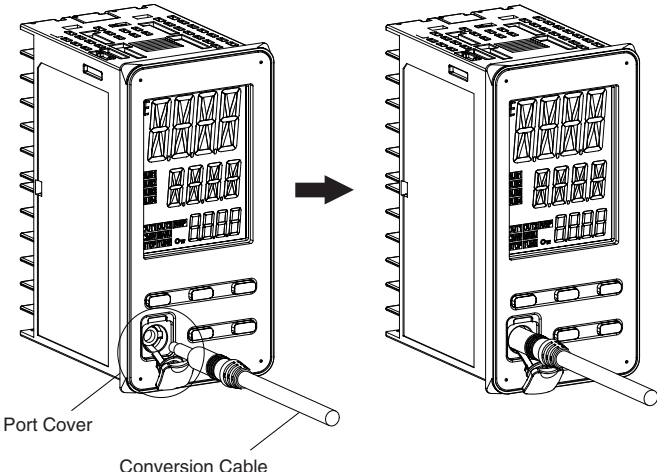
<p>1 Connect the E58-CIFQ2 USB-Serial Conversion Cable to the E58-CIFQ2-E Conversion Cable.</p>	 <p>E58-CIFQ2 USB-Serial Conversion Cable</p> <p>E58-CIFQ2-E Conversion Cable</p> <p>There is a triangle on the connecting surface.</p> <p>Align the arrow (⇔) on the small connector on the E58-CIFQ2 USB-Serial Conversion Cable with the triangle mark (△) on the small connector on the E58-CIFQ2-E Conversion Cable.</p>
<p>2 Remove the Port Cover from the front-panel Setup Tool port, and then plug in the Conversion Cable.</p>	 <p>Port Cover</p> <p>Conversion Cable</p>



Precautions for Correct Use

- Hold the connector when inserting or disconnecting the Cable.
- When connecting a connector, always make sure that it is oriented correctly. Do not force the connector if it does not connect smoothly. Connectors may be damaged if they are connected with excessive force.
- Do not connect cables to both the front-panel Setup Tool port and the top-panel Setup Tool port at the same time. The Digital Controller may be damaged or may malfunction.

2-4-3 Installing the Driver

1. Connect a USB connector on the computer with a Setup Tool port on the Digital Controller using the Cable or Cables.

2. Obtaining the Driver

When the CX-Thermo Support Software for the Digital Controller is installed, the driver for the USB-Serial Conversion Cable will be copied to the following folder.

C:\Program Files\OMRON\Drivers\USB\E58-CIF

3. Installing the Driver

Install the driver to enable the Cable to be used with the personal computer.

- Installation

When the Cable is connected with the personal computer, the OS will detect the product as a new device. At this time, install the driver using the Installation Wizard.

Note 1: We recommend that you install the driver for each USB port on the computer at the start. The Digital Controller assigns a COM port number to each USB port on the computer. If the same USB port is used, you will be able to use the same COM port number even if you use a different Cable.

2: Installation of the driver will not be completed if the installation is canceled before it is completed. Normal communications will not be possible unless the driver is installed completely. If the driver is not installed completely, uninstall it, and then install it correctly.

4. Setting Setup Tool Communications Conditions

Set the communications port (COM port) number to be used for the CX-Thermo Setup Tool to the COM port number assigned to the USB-Serial Conversion Cable.

Refer to the E58-CIFQ2 USB-Serial Conversion Cable Instruction Manual and Setup Manual for details on how to check the COM port assigned to the USB-Serial Conversion Cable.

The communications conditions for Setup Tool COM ports are fixed as shown in the table below. Set the communications conditions for the CX-Thermo Setup Tool according to the following table

Parameter	Set value
Communications Unit No.	01
Communications baud rate	38.4 (kbps)
Communications data length	7 (bits)
Communications stop bits	2 (bits)
Communications parity	Even

3

Part Names and Basic Procedures

3

3-1	Basic Application Flow	3-2
3-2	Power ON	3-3
3-3	Part Names, Part Functions, and Setting Levels	3-4
3-3-1	Part Names and Functions	3-4
3-3-2	Entering Numeric Values	3-7
3-3-3	Setting Levels	3-8
3-3-4	E5CC/E5EC Setting Levels	3-9
3-4	Procedures after Turning ON the Power Supply	3-13
3-4-1	Basic Flow of Operations	3-13
3-4-2	Basic Procedure	3-13

3-1 Basic Application Flow

The following figure shows the basic flow for using the Digital Controller.

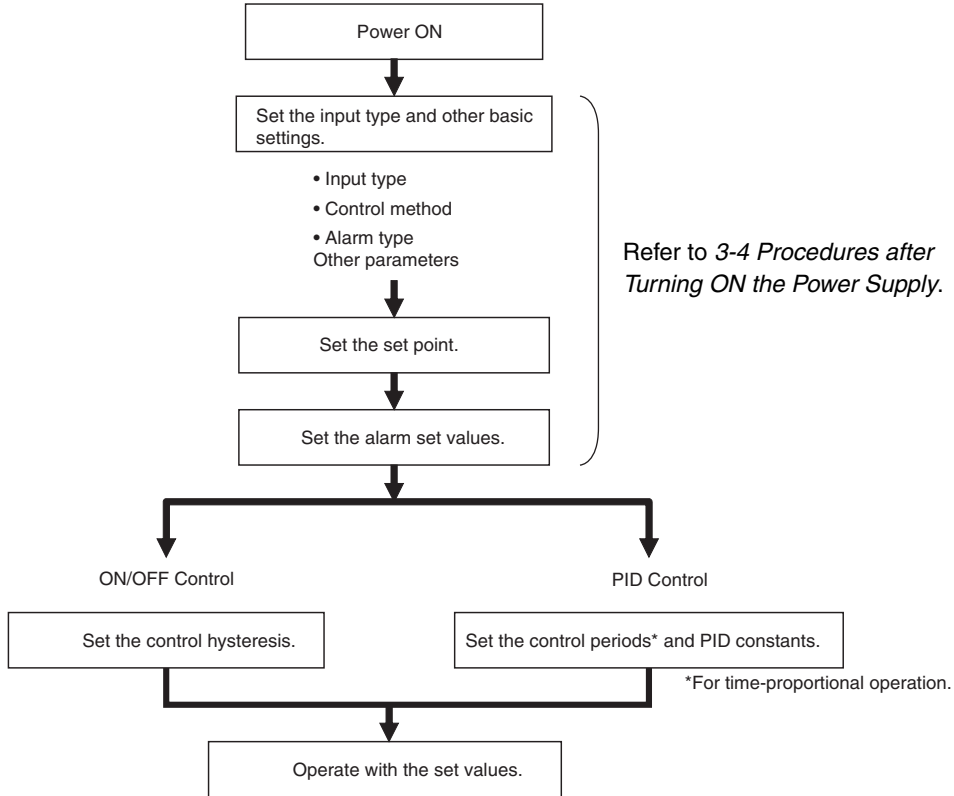

3-2 Power ON

Operation will start as soon as you turn ON the power supply to the E5CC/E5EC.
The following default settings will be used when operation starts.

- Input type 5: K thermocouple
- ON/OFF control
- Alarm: Upper-limit alarm*
- Set point: 0°C

* If the Controller is equipped with HB/HS alarm detection, it is set by default to detect heater alarms.

After the power comes ON, all indicators and displays will light for approximately 1 second, and then the operation display will appear.

The top display will show the PV and the bottom display will show the SP.

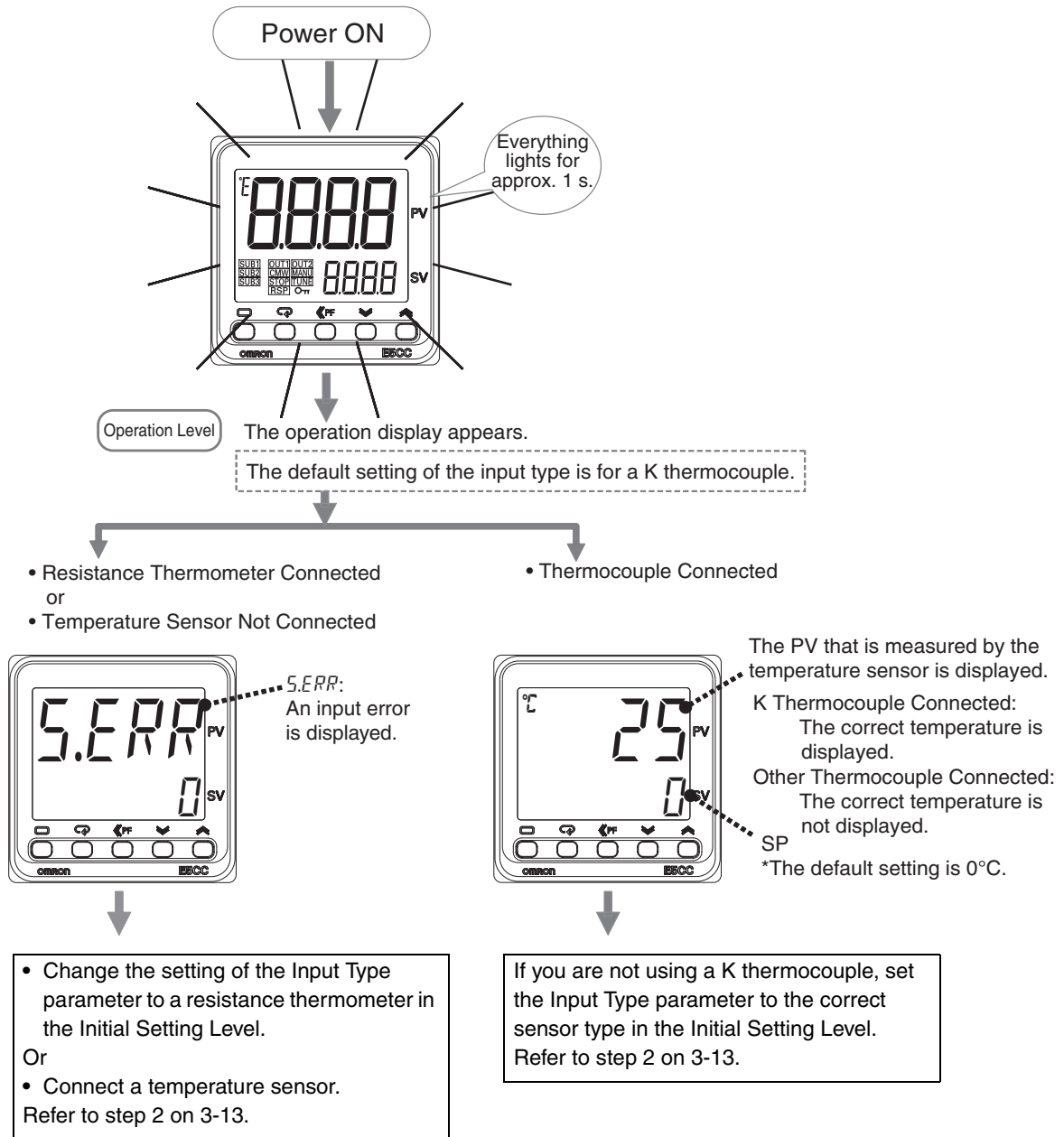

3-3 Part Names, Part Functions, and Setting Levels

3-3-1 Part Names and Functions

E5CC

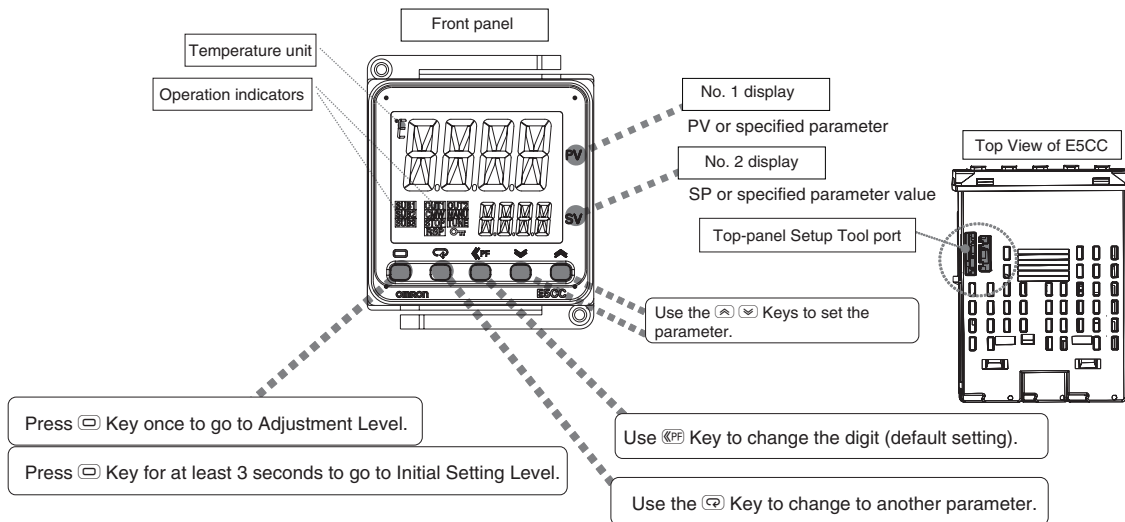

E5EC

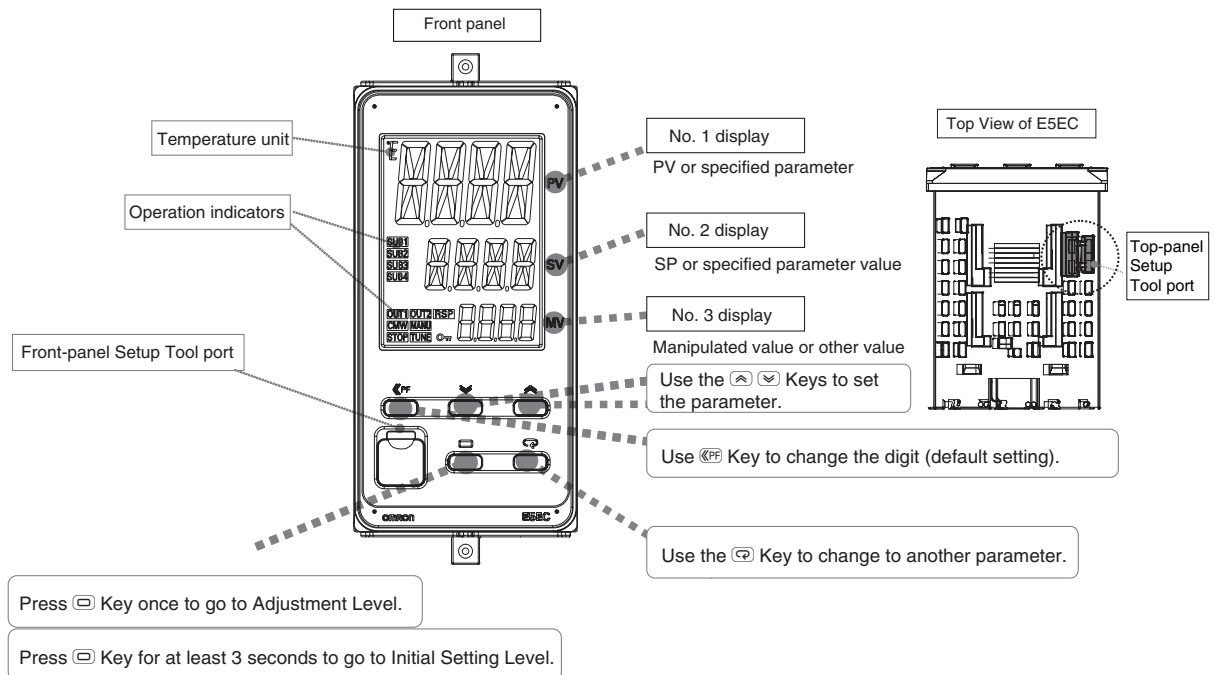









Displays

Display	Name	Description
E5CC: Top display E5EC: Top display	No. 1 display	Displays the process value or a monitor/setting item.
E5CC: Bottom display E5EC: Middle display	No. 2 display	Displays the set point or the value of a monitor/setting item.
E5CC: None E5EC: Bottom display	No. 3 Display (E5EC only)	Displays the manipulated variable, remaining soak time, multi-SP No., internal SP (ramp SP), or alarm value 1. (The value that is displayed is set in the PV/SP Display Selection parameter in the Advanced Function Setting Level.)
°C or °F	Temperature unit	Displays the temperature unit.



Indicators

Operation indicators	Name	Description
SUB1 SUB2 SUB3 SUB4 (E5EC only)	Auxiliary outputs 1 to 4 (Only the E5EC support auxiliary output 4.)	Each indicator lights when the function that is assigned to corresponding auxiliary output (1 to 4) is ON.
OUT1 OUT2	Control outputs 1 and 2	Each indicator lights when the function that is assigned to corresponding control output (1 or 2) is ON. (For a current output, the indicator is not lit only for a 0% output.)
CMW	Communications writing control	This indicator lights when wiring with communications is enabled.
MANU	Manual	This indicator is lit in Manual Mode.
STOP	Stop	This indicator is lit while operation is stopped.
TUNE	AT/ST in progress	This indicator is lit during autotuning. This indicator flashes during self-tuning.
RSP	Remote SP	This indicator is lit while the SP Mode parameter is set to Remote SP Mode. This indicator flashes when there is an RSP input error in Remote SP Mode.
OP	Setting change protection	This indicator is lit while setting change protection is ON.

Keys



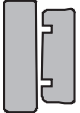

Key	Name	Overview	Description
	Level Key	<p>Selects the setting level.</p> <p>The next setting level depends on how long the key is pressed.</p>	<ul style="list-style-type: none"> In Operation Level <ul style="list-style-type: none"> Press once for less than 1 second to go to Adjustment Level. Press for at least 3 seconds to go to Initial Setting Level. In Adjustment Level <ul style="list-style-type: none"> Press once for less than 1 second to go to Operation Level. Press for at least 3 seconds to go to Initial Setting Level. In Initial Setting Level <ul style="list-style-type: none"> Press for at least 1 second to go to Operation Level. Display <i>MMdV</i> (Move to Advanced Function Setting Level) and then enter -169 to go to Advanced Function Setting Level.
	Mode Key	Changes the parameter that is displayed within a setting level.	<ul style="list-style-type: none"> Press once to go to the next parameter. Hold to go to the previous parameter.
	Down Key and Up Key	Set the value.	<ul style="list-style-type: none"> Hold the key to increment or decrement the value quickly. Any changes in settings are applied at the following times: <ul style="list-style-type: none"> After 3 seconds elapse When the  Key is pressed When the level is changed with the  Key
	Shift Key (PF Key)	Operates as a user-defined function key.	<ul style="list-style-type: none"> Press the  to select the digit to change. You can change the PF Setting parameter to assign any of the following functions. Press the  Key for at least 1 second and then specify one of the following functions: RUN/STOP, auto/manual, autotuning, or canceling an alarm latch <p>The PF Key operates as a Digit Shift Key by default.</p> <p>Example: If you set the PF Setting parameter to STOP, operation will stop when you press the PF Key for at least 1 second.</p> <ul style="list-style-type: none"> Press the PF Key once to display the Monitor/Setting Item Level. <p>The parameter that is displayed is set in the Monitor/Setting Item parameters in the Advanced Function Setting Level.</p>

Setup Tool Ports

Setup Tool port	Name	Description
	Top-panel Setup Tool port	Use the E58-CIFQ2 USB-Serial Conversion Cable to connect the E5CC/E5EC to the computer (i.e., the CX-Thermo Support Software).
	Front-panel Setup Tool port (E5EC only)	Use the E58-CIFQ2 USB-Serial Conversion Cable and the E58-CIFQ2-E Conversion Cable to connect the E5EC to the computer (i.e., the CX-Thermo Support Software).

3-3-2 Entering Numeric Values



Applying Changes to Numeric Values

After you change a numeric value with the   Keys, the changes are applied 1) when 3 seconds elapses, 2) when the  Key is pressed, or 3) when the level is changed with the  Key.



Precautions for Correct Use



Always make sure that any changes to numeric values are applied for one of the three methods that are given above before you turn OFF the power supply to the E5CC/E5EC.

If you only change the values with the   Keys and turn OFF the power supply before 3 seconds has elapsed, the changes will not be applied.

Moving between Digits (Digit Shift Key)

Press the Shift Key (PF Key) to select the digit to change.

This is useful when entering a numeric value with many digits.

Use this key to change levels: The digit to change will move as follows: 1s digit, 10s digit, 100s digit, 1000s digit, and then back to the 1s digit. Press the  +  Keys to change the value of a digit.

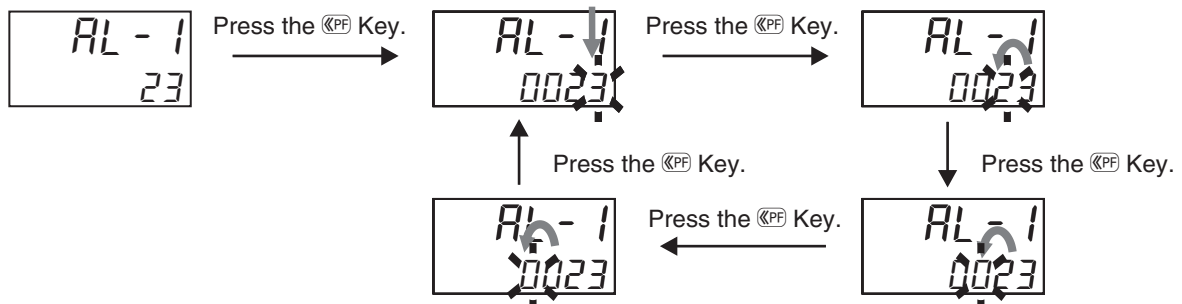

3-3-3 Setting Levels

What Are Setting Levels?

On the E5CC/E5EC, the parameters are classified into levels according to their applications. These levels are called setting levels. The setting levels consist of some basic setting levels and other setting levels.

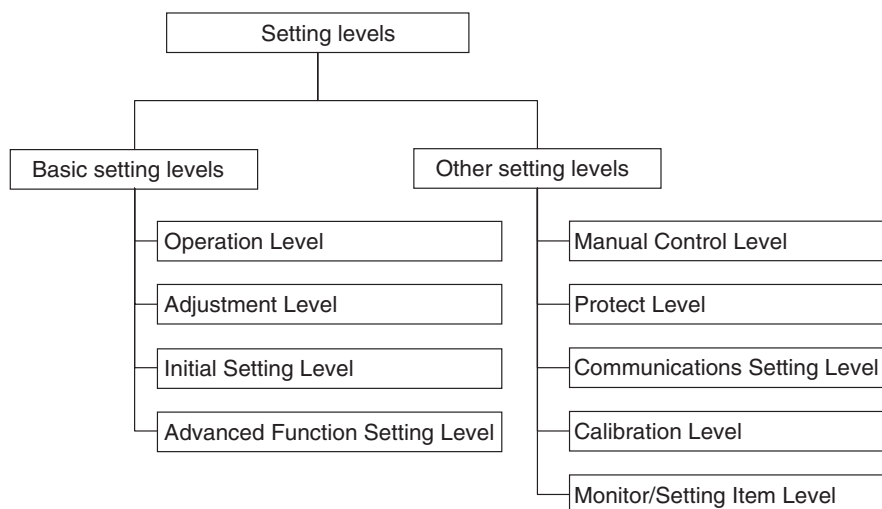

The setting levels are described in more detail in the following tables.

● Basic Setting Levels

The basic setting levels are the levels that are used most frequently.

Application of the parameters	Setting level name	Operation status
Level that is used for operation	Operation Level	Operating
Level that is used for adjustments	Adjustment Level	Operating
Level that is used for initial settings	Initial Setting Level	Stopped
	Advanced Function Setting Level	

● Other Setting Levels

The other setting levels are used as required.

Application of the parameters	Setting level name	Operation status
Level that is used for communications settings	Communications Setting Level	Stopped
Level that is used for manual operation	Manual Control Level	Operating
Level that is used to set protection	Protect Level	Operating
Level that is used for calibration	Calibration Level	Stopped
Level that is displayed when the ⓀPF Key is pressed	Monitor/Setting Item Level*	Operating

The Operation Level, Adjustment Level, Initial Setting Level, and Advanced Function Setting Level are used most commonly. They are therefore described separately from the other setting levels under Basic Setting Levels, below.

* To use the ⓀPF Key to display the Monitor/Setting Items, change the setting of the PF Setting parameter to *PFdP*.

3-3-4 E5CC/E5EC Setting Levels

Moving between Setting Levels

The following figure gives an overall image of the setting levels. The setting levels consist of the basic setting levels (shaded below) and the other setting levels (not shaded).

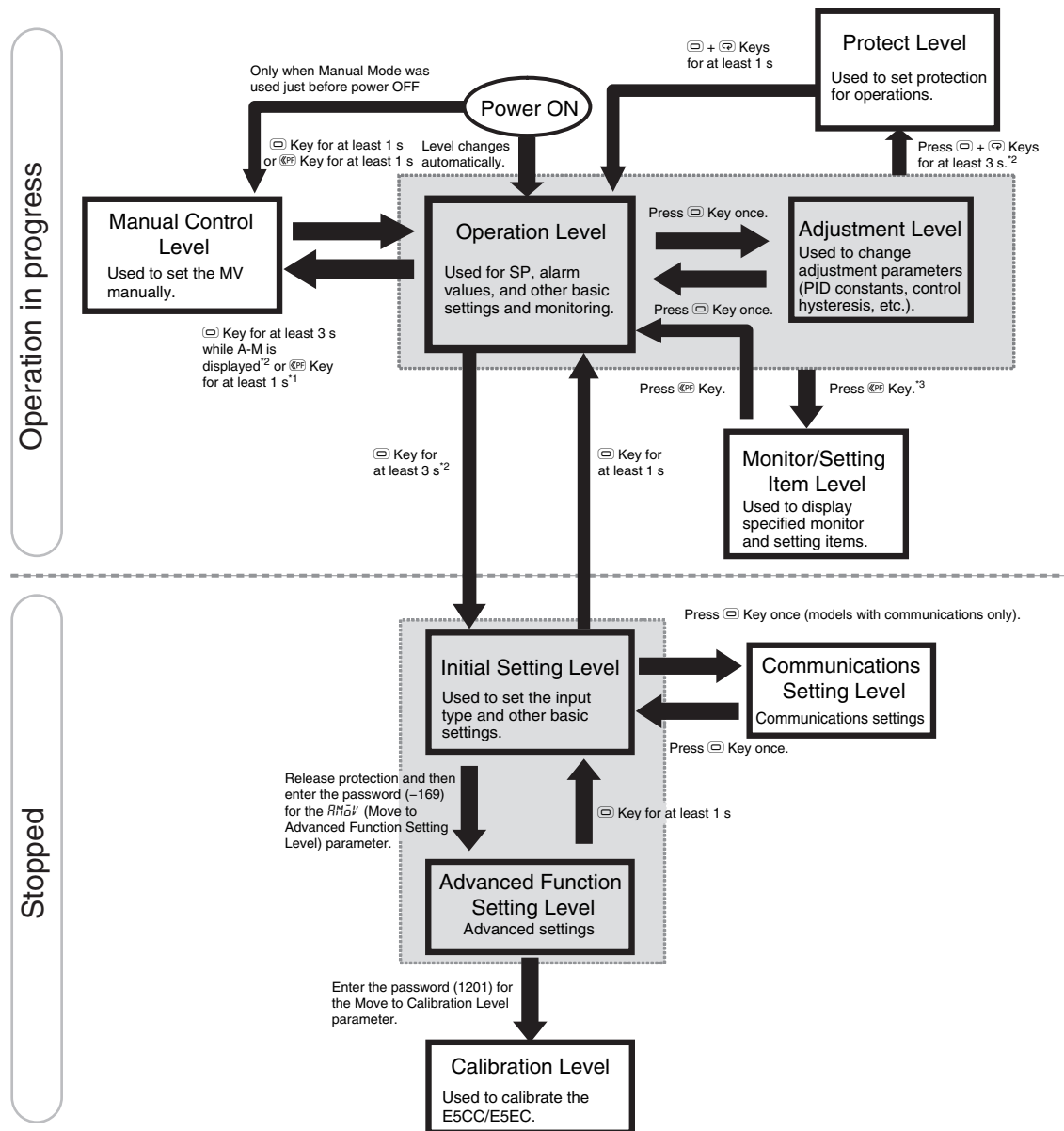

*1 To use a key procedure to move to Manual Control Level, set the Auto/Manual Select Addition parameter to ON and set the PF Setting parameter to $R-M$ (Auto/Manual).
 *2 The No. 1 display will flash when the keys are pressed for 1 s or longer.
 *3 Set the PF Setting parameter to $PFdP$ (monitor/setting items).

Basic Setting Levels

The following figure shows the basic setting levels (shaded).

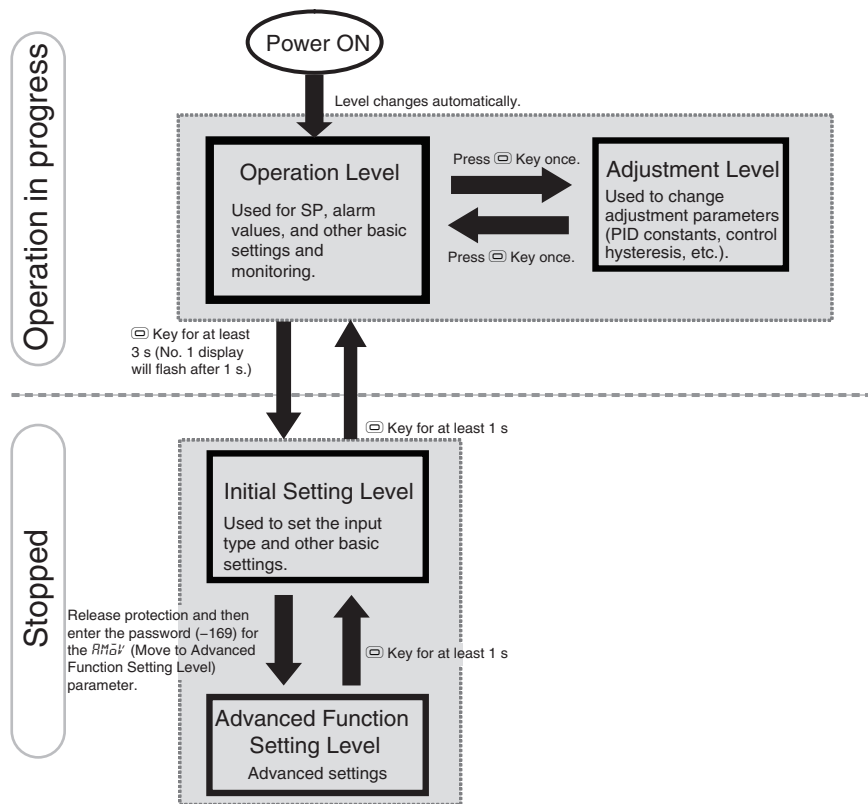

● Operation Level

This level is displayed automatically when the power supply is turned ON.

This level is used for the SP, alarm values, and other basic settings and monitoring.

Normally, select this level for operation.

● Adjustment Level

This level is used to set the PID constants and to perform tuning, such as autotuning.

In Adjustment Level, the settings of the parameters can be changed during operation. This is not possible in the Initial Setting Level or Advanced Function Setting Level.

● Initial Setting Level

This level is used for the most basic settings.

It is used to set the input type and other parameters.

Use it to set the input type, alarm type, and other basic settings.

● Advanced Function Setting Level

This level is used for advanced settings.

Use it to assign functions to the control outputs and auxiliary outputs.

You will not be able to enter the Advanced Function Setting Level with the default settings.

To enter the Advanced Function Setting Level, first disable Initial Setting/Communications Protection and then enter the password (-169) at the *RM0V* (Move to Advanced Function Setting Level) parameter in the Initial Setting Level.

Use the following procedure to move to Advanced Function Setting Level.

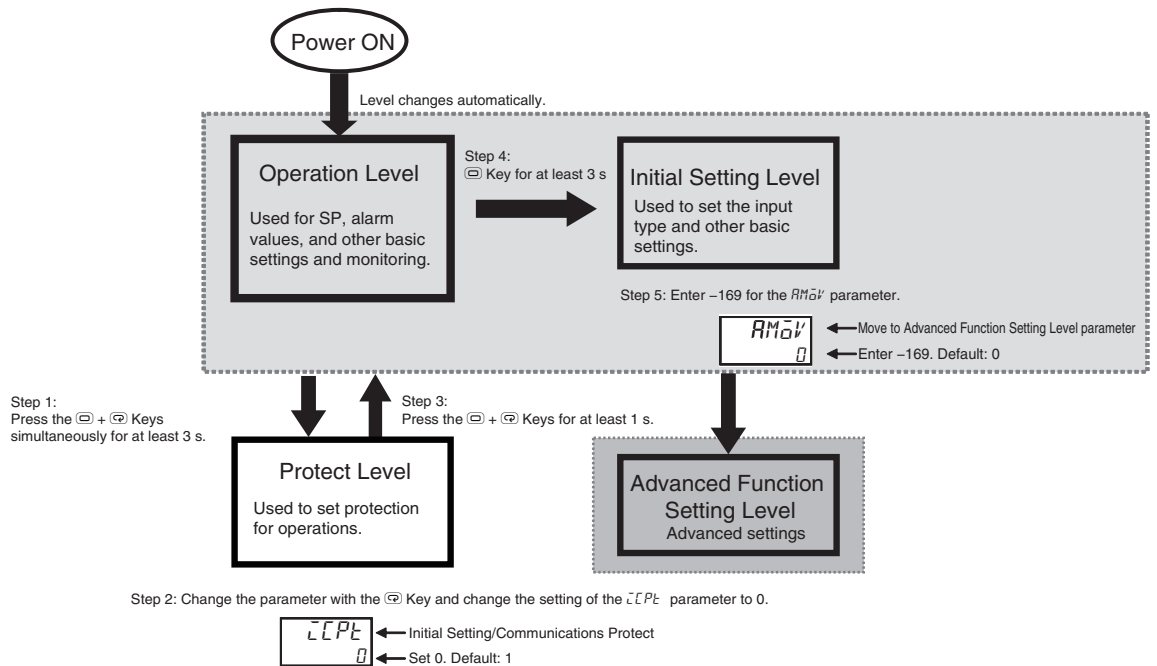

Step 1: Move to Protect Level.

Step 2: Display LCP (Initial Setting/Communications Protect) and set it to 0.

Step 3: Return to Operation Level.

Step 4: Return to Initial Setting Level.

Step 5: Display RMGV (Move to Advanced Function Setting Level) and then enter -169.

Steps 1 to 3 are necessary only the first time. Perform only steps 4 and 5 to move to Advanced Function Setting Level.

Other Setting Levels

There are five other setting levels: Manual Control Level, Protect Level, Communications Setting Level, Calibration Level, and Monitor/Setting Item Level.

● Manual Control Level

This level is used to set the MV manually. With the default settings, you cannot move to the Manual Control Level.

- To use the Ⓢ Key to move to the Manual Control Level, change the setting of the PF Setting parameter to R-M .
- To use the Level Key on the Auto/Manual Switch Display to move to the Manual Control Level, set the Auto/Manual Switch Display Addition parameter in the Advanced Function Setting Level to ON.
- To use an event input to move to the Manual Control Level, change the setting of the Event Input Assignment 1 to 6 parameter to MANU .

● Protect Level

This level is used to restrict the operations that can be performed and the parameters that can be displayed with the front-panel keys. For example, you can prohibit changing the SP and other parameters in the Operation Level and Adjustment Level. You can move to the Protect Level from the Operation Level or the Adjustment Level. To move to the Advanced Function Setting Level, you must first cancel the protection that is set in the Protect Level.

● **Communications Setting Level**

This level is used to set the communications parameters. You can move to the Communications Setting Level from the Initial Setting Level.

● **Calibration Level**

This level is used to calibrate the Digital Controller. You can move to the Calibration Level from the Advanced Function Setting Level.

● **Monitor/Setting Item Level**

To use the \llbracket PF \rrbracket Key to display the Monitor/Setting Items, change the setting of the PF Setting parameter to PF_{dP} . The items that will be displayed in the Monitor/Setting Item Level are set using the Monitor/Setting Item 1 to 5 parameters.

3-4 Procedures after Turning ON the Power Supply

3-4-1 Basic Flow of Operations

The basic flow of operations after you turn ON the power supply is shown below.

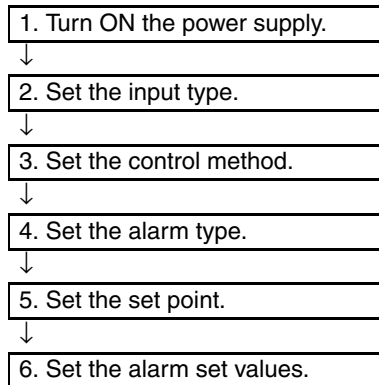

3-4-2 Basic Procedure

The basic procedure is given below.

1 Turn ON the power supply.

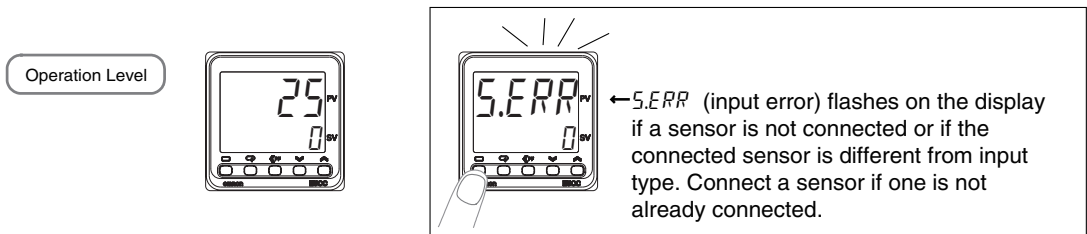

2 Set the input type.

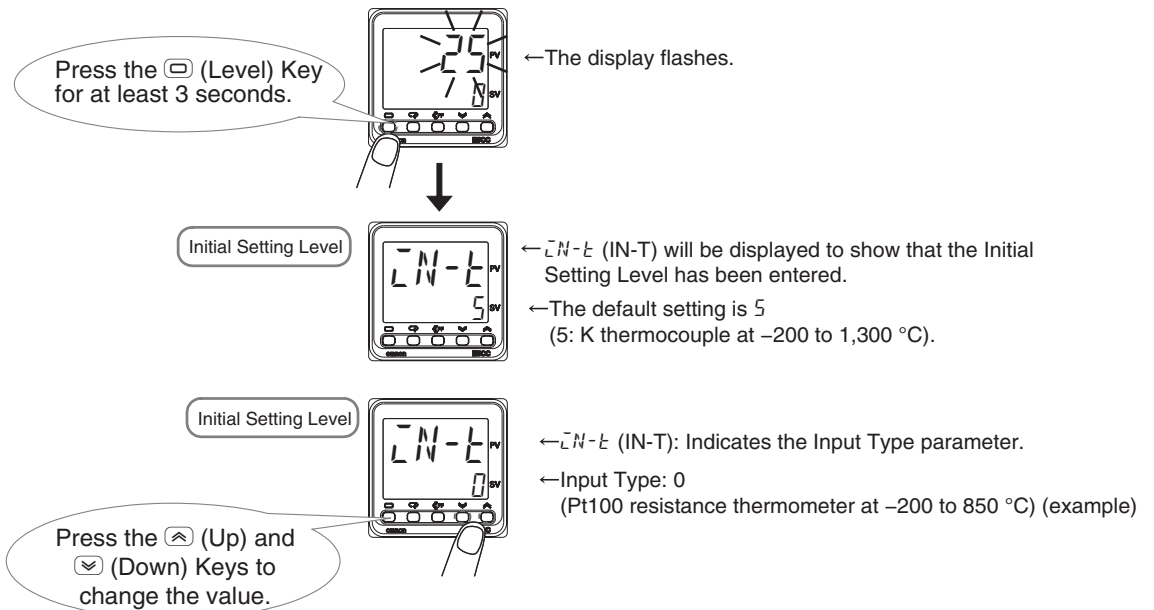

When you are finished, press the (Level) Key for at least 1 second to return to the operation display.

List of Input Types

Input type	Specifications	Set value	Temperature range in °C	Temperature range in °F
Resistance thermometer	Pt100	0	-200 to 850	-300 to 1500
		1	-199.9 to 500.0	-199.9 to 900.0
		2	0.0 to 100.0	0.0 to 210.0
	JPt100	3	-199.9 to 500.0	-199.9 to 900.0
4		0.0 to 100.0	0.0 to 210.0	
Thermocouple	K	5*	-200 to 1300	-300 to 2300
		6	-20.0 to 500.0	0.0 to 900.0
	J	7	-100 to 850	-100 to 1500
		8	-20.0 to 400.0	0.0 to 750.0
	T	9	-200 to 400	-300 to 700
		10	-199.9 to 400.0	-199.9 to 700.0
	E	11	-200 to 600	-300 to 1100
	L	12	-100 to 850	-100 to 1500
	U	13	-200 to 400	-300 to 700
		14	-199.9 to 400.0	-199.9 to 700.0
	N	15	-200 to 1300	-300 to 2300
	R	16	0 to 1700	0 to 3000
	S	17	0 to 1700	0 to 3000
	B	18	100 to 1800	300 to 3200
W	19	0 to 2300	0 to 3200	
PLII	20	0 to 1300	0 to 2300	
Infrared temperature sensor ES1B	10 to 70°C	21	0 to 90	0 to 190
	60 to 120°C	22	0 to 120	0 to 240
	115 to 165°C	23	0 to 165	0 to 320
	140 to 260°C	24	0 to 260	0 to 500
Current input	4 to 20 mA	25	One of the following ranges according to the scaling: -1999 to 9999	
	0 to 20 mA	26		
Voltage input	1 to 5 V	27	-199.9 to 999.9 -19.99 to 99.99 -1.999 to 9.999	
	0 to 5 V	28		
	0 to 10 V	29		

* The default is 5.

3 Set the control method.

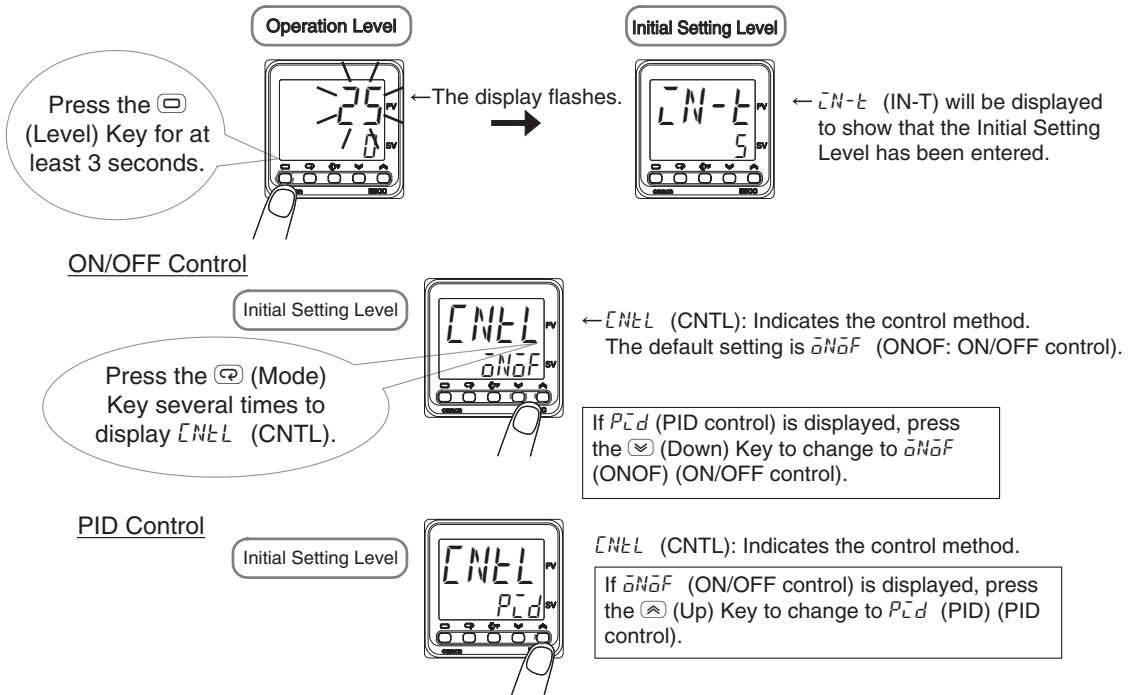

4 Set the alarm type.

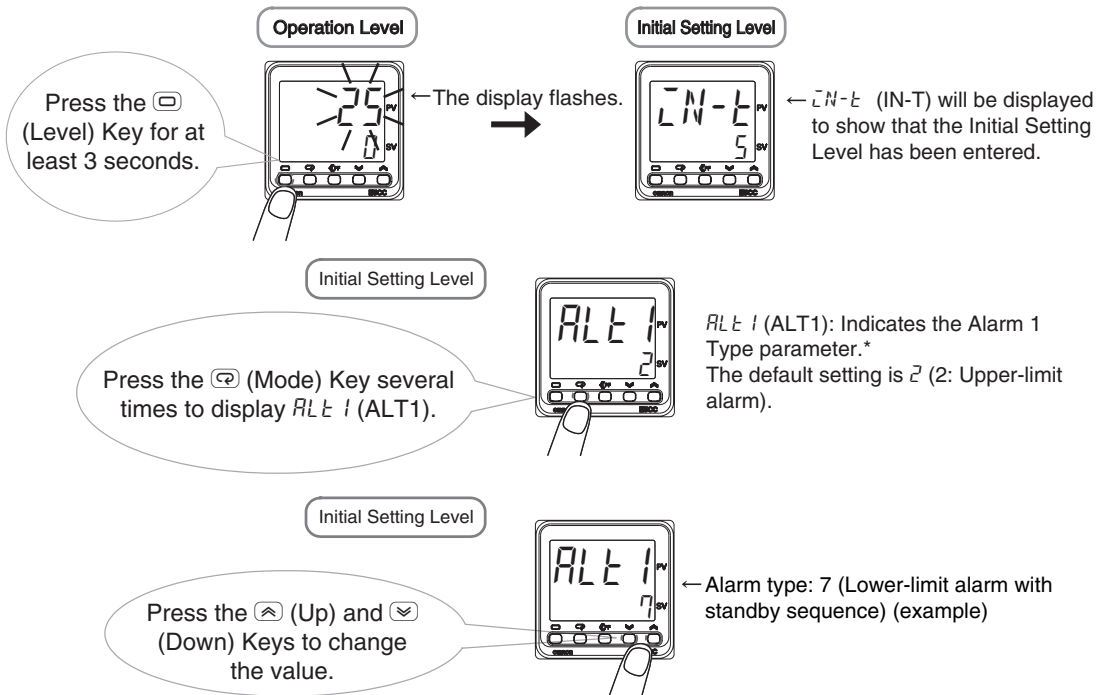

* If the Controller is equipped with HB/HS alarm detection, the Alarm 1 Type is not displayed for the default settings. To use alarm 1, set an output assignment to alarm 1. For details, refer to 4-6-3 Assigned Output Functions.

If required, use the [Mode] Key and the [Up] and [Down] Keys to repeat the procedure to set alarm types for ALT2 (Alarm 2 Type) and ALT3 (Alarm 3 Type). (The number of alarms that is supported depends on the model of Digital Controller. Some of the alarm parameters may not be displayed.)

When you are finished, press the [Level] Key for at least 1 second to return to the operation display.

Alarm Type Numbers

Alarm type No.	Alarm type	Description	Operation
0	Alarm function OFF	There will be no alarm outputs.	---
1	Upper- and lower-limit alarm	The alarm output is ON while the PV is equal to or higher than the upper-limit alarm point or while the PV is equal to or lower than the lower-limit alarm point.	Example:
2	Upper-limit alarm	The alarm output is ON while the PV is equal to or higher than the upper-limit alarm point.	Example:
3	Lower-limit alarm	The alarm output is ON while the PV is equal to or lower than the lower-limit alarm point.	Example:
4	Upper- and lower-limit range alarm	The alarm output is ON while the PV is equal to or lower than the upper-limit alarm point or equal to or higher than the lower-limit alarm point.	Example:
5	Upper- and lower-limit alarm with standby sequence	This alarm provides a standby sequence. The alarm output is ON while the PV is equal to or higher than the upper-limit alarm point or while the PV is equal to or lower than the lower-limit alarm point.	Example:
6	Upper-limit alarm with standby sequence	This alarm provides a standby sequence. The alarm output is ON while the PV is equal to or higher than the upper-limit alarm point.	Example:
7	Lower-limit alarm with standby sequence	This alarm provides a standby sequence. The alarm output is ON while the PV is equal to or lower than the lower-limit alarm point.	Example:

Alarm type No.	Alarm type	Description	Operation
8	Absolute-value upper-limit alarm	The alarm output is ON while the PV is equal to or higher than the alarm value.	<p>Example:</p>
9	Absolute-value lower-limit alarm	The alarm output is ON while the PV is equal to or lower than the alarm value.	<p>Example:</p>
10	Absolute-value upper-limit alarm with standby sequence	This alarm provides a standby sequence. The alarm output is ON while the PV is equal to or higher than the alarm value.	<p>Example:</p>
11	Absolute-value lower-limit alarm with standby sequence	This alarm provides a standby sequence. The alarm output is ON while the PV is equal to or lower than the alarm value.	<p>Example:</p>
12	Loop Burnout Alarm (LBA) (Valid only for alarm 1.)	The alarm output turns ON when the control loop is broken.	<p>There is assumed to be a loop burnout alarm if the control deviation (SP – PV) is greater than the threshold set in the LBA Level parameter and if the PV is not reduced by at least the value set in the LBA Band parameter within a specific period of time. The LBA detection time and LBA band are set in parameters.</p>

Alarm type No.	Alarm type	Description	Operation
13	PV change rate alarm	The alarm output turns ON if the change in the PV within the specified calculation period exceeds a specific width.	<p>The PV rate of change calculation period and the alarm value are set in parameters.</p>
14	SP absolute-value upper-limit alarm	The alarm output is ON while the SP is equal to or higher than the alarm value.	<p>Example:</p>
15	SP absolute-value lower-limit alarm	The alarm output is ON while the SP is equal to or lower than the alarm value.	<p>Example:</p>
16	MV absolute-value upper-limit alarm	The alarm output is ON while the MV is equal to or higher than the alarm value.	<p>Example for Standard Control:</p>
17	MV absolute-value lower-limit alarm	The alarm output is ON while the MV is equal to or lower than the alarm value.	<p>Example for Standard Control:</p>
18	RSP absolute-value upper-limit alarm	The alarm output is ON while the RSP is equal to or higher than the alarm value.	<p>Example:</p>
19	RSP absolute-value lower-limit alarm	The alarm output is ON while the RSP is equal to or lower than the alarm value.	<p>Example:</p>

5 Set the set point.

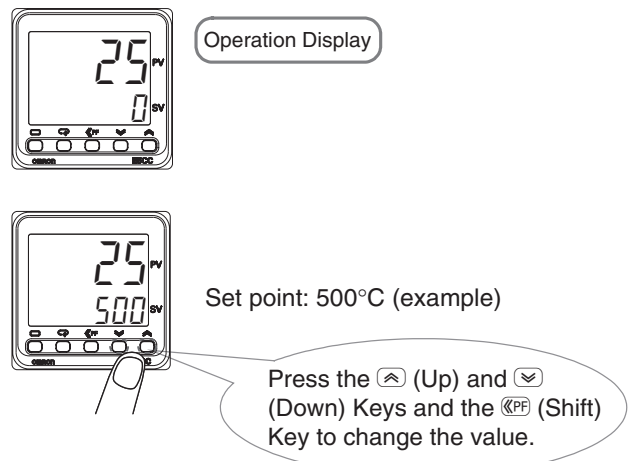

*Hold the (Up) or (Down) Key to increment or decrement the value quickly.

6 Set the alarm set value or values.

Change the parameter that is displayed with the (Mode) Key.

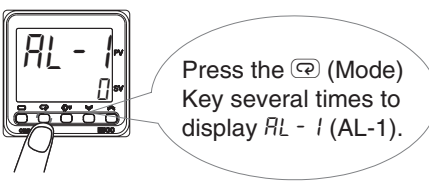
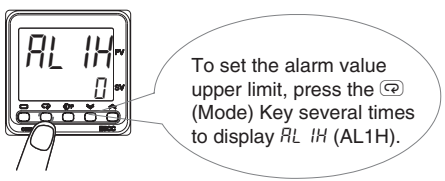
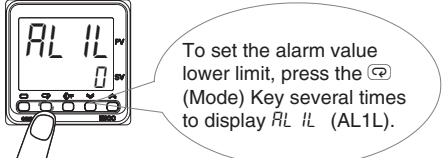
Alarm Type 2, 3, 6, 7, 8, 9,10, or 11 (Upper-limit Alarms and Lower-limit Alarms)	Alarm Type 1, 4, or 5 (Upper-limit and Lower-limit Alarms or Upper-limit and Lower-limit Range Alarms)
<p>Operation Level</p> 	 

This concludes the procedure to set the input type, alarm type, control method, set point, and alarm set values. For information on the settings of the ON/OFF hysteresis, PID constants, HS alarm, HS alarm, and other parameters, refer to *Section 4 Basic Operation* or *Section 5 Advanced Operations*.

4

Basic Operation

4-1	Moving between Setting Levels	4-3
4-1-1	Moving to the Initial Setting Level	4-3
4-1-2	Moving to the Adjustment Level	4-4
4-1-3	Moving to the Protect Level	4-4
4-1-4	Moving to the Advanced Function Setting Level	4-5
4-1-5	Moving to the Communications Setting Level	4-7
4-2	Initial Setting Examples	4-8
4-3	Setting the Input Type	4-10
4-3-1	Input Type	4-10
4-4	Selecting the Temperature Unit	4-12
4-4-1	Temperature Unit	4-12
4-5	Selecting PID Control or ON/OFF Control	4-13
4-6	Setting Output Specifications	4-14
4-6-1	Control Periods	4-14
4-6-2	Direct and Reverse Operation	4-14
4-6-3	Assigned Output Functions	4-15
4-6-4	Auxiliary Output Opening or Closing in Alarm	4-18
4-7	Setting the Set Point (SP)	4-19
4-7-1	Changing the SP	4-19
4-8	Using ON/OFF Control	4-20
4-8-1	ON/OFF Control	4-20
4-8-2	Settings	4-21
4-9	Determining PID Constants (AT, ST, Manual Setup)	4-23
4-9-1	AT (Auto-tuning)	4-23
4-9-2	ST (Self-tuning)	4-25
4-9-3	Manual Setup	4-28
4-10	Alarm Outputs	4-30
4-10-1	Alarm Types	4-30
4-10-2	Alarm Values	4-34
4-11	Alarm Hysteresis	4-37
4-11-1	Standby Sequence	4-37
4-11-2	Alarm Latch	4-38

4-12 Using Heater Burnout (HB) and Heater Short (HS) Alarms	4-39
4-12-1 HB Alarm	4-39
4-12-2 HS Alarm	4-41
4-12-3 Installing Current Transformers (CT)	4-43
4-12-4 Calculating Detection Current Values	4-45
4-12-5 Application Examples	4-45
4-13 Customizing the PV/SP Display	4-49
4-13-1 PV/SP Display Selections	4-49

4-1 Moving between Setting Levels

The Operation Level is displayed first when the power supply to the Digital Controller is turned ON. To display the parameters, you must move to the following setting levels.

- Operation Level (Entered when the power supply is turned ON.)
- Initial Setting Level
- Adjustment Level
- Protect Level
- Advanced Function Setting Level
- Communications Setting Level

The procedures to move between the setting levels starting from the Operation Level are provided below.

4-1-1 Moving to the Initial Setting Level

Moving from the Operation Level to the Initial Setting Level

1 Press the Key for at least 3 seconds in the Operation Level.

The No. 1 display will flash when the key is pressed for 1 s or longer.

The display will change from the Operation Level to the Initial Setting Level.

Operation Level

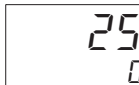

Initial Setting Level

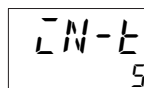

Moving from the Initial Setting Level to the Operation Level

1 Press the Key for at least 1 second in the Initial Setting Level.

The display will change from the Initial Setting Level to the Operation Level.

Initial Setting Level

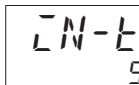

Operation Level

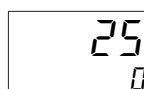

4-1-2 Moving to the Adjustment Level

Moving from the Operation Level to the Adjustment Level

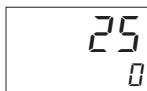
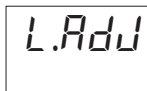

<p>1 Press the  Key for less than 1 second in the Operation Level.</p> <p>The display will change from the Operation Level to the Adjustment Level.</p> <p>* <i>L.ADJ</i> will be displayed only once when you move to the Adjustment Level.</p>	<p>Operation Level</p> 
	<p>Adjustment Level</p> 

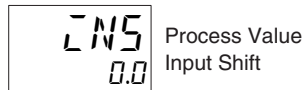
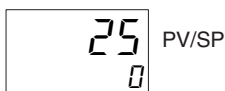
Moving from the Adjustment Level to the Operation Level



<p>1 Press the  Key for less than 1 second in the Adjustment Level.</p> <p>The display will change from the Adjustment Level to the Operation Level.</p>	<p>Adjustment Level</p> 
	<p>Operation Level</p> 

4-1-3 Moving to the Protect Level

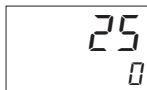
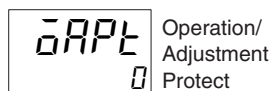
Moving from the Operation Level to the Protect Level

<p>1 Press the  and  Keys simultaneously for at least 3 seconds* in the Operation Level.</p> <p>The No. 1 display will flash when the keys are pressed for 1 s or longer.</p> <p>* The key pressing time can be changed in the Move to Protect Level Time parameter in the Advanced Function Setting Level.</p> <p>The display will change to the Protect Level.</p>	<p>Operation Level</p> 
	<p>Protect Level</p> 

Moving from the Protect Level to the Operation Level

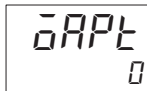
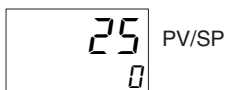

<p>1 Press the  and  Keys simultaneously for at least 1 second in the Protect Level.</p> <p>The display will change from the Protect Level to the Operation Level.</p>	<p>Protect Level</p> 
	<p>Operation Level</p> 

4-1-4 Moving to the Advanced Function Setting Level

Moving to the Advanced Function Setting Level for the First Time (i.e., with the Default Settings)

To enter the Advanced Function Setting Level, you must first enter the Protect Level and change the setting of the $\overline{CCP\bar{L}}$ (Initial Setting/Communications Protect) parameter to 0 (enable moving to Advanced Function Setting Level) to clear the protection.

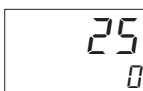
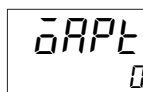
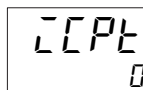

● Clearing Protection

<p>1 Press the \ominus and \oplus Keys simultaneously for at least 3 seconds* in the Operation Level.</p> <p>The No. 1 display will flash when the key is pressed for 1 s or longer.</p> <p>* The key pressing time can be changed in the Move to Protect Level Time parameter in the Advanced Function Setting Level.</p> <p>The display will change to the Protect Level.</p>	<p>Operation Level</p> 
<p>2 Press the \oplus Key once at the Operation/Adjustment Protect parameter.</p> <p>The display will change to the Initial Setting/Communications Protect parameter.</p>	<p>Protect Level</p>  <p>Operation/Adjustment Protect</p>
<p>3 Press the \downarrow or \uparrow Key at the Initial Setting/Communications Protect parameter to change the set value to 0 (enable moving to Advanced Function Setting Level).</p> <p>Now the $\overline{AM\bar{O}\bar{V}}$ (Move to Advanced Function Setting Level) parameter can be displayed in the Initial Setting Level.</p> <p>The default is 1 (disable moving to Advanced Function Setting Level).</p>	<p>$\overline{CCP\bar{L}}$</p> <p>Initial Setting/Communications Protect</p> <p>1: Moving to Advanced Function Setting Level is disabled.</p>
<p>4 Press the \ominus and \oplus Keys simultaneously for at least 1 second in the Protect Level.</p> <p>The display will change from the Protect Level to the Operation Level.</p>	<p>Protect Level</p>  <p>Initial Setting/Communications Protect</p> <p>Operation Level</p>  <p>PV/SP</p>

Moving to the Advanced Function Setting Level after Clearing Protection

After you have set the \overline{CPL} (Initial Setting/Communications Protect) parameter to $\overline{0}$ (enable moving to Advanced Function Setting Level), select $AM\overline{OV}$ (Move to Advanced Function Setting Level) in the Initial Setting Level.

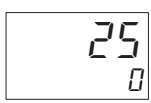
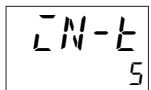
● Moving to the Advanced Function Setting Level

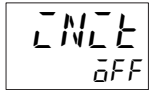

<p>1 Press the $\overline{\text{CPL}}$ Key for at least 3 seconds in the Operation Level. The No. 1 display will flash when the key is pressed for 1 s or longer. The display will change from the Operation Level to the Initial Setting Level.</p>	<p>Operation Level</p> 
<p>2 Press the $\overline{\text{CPL}}$ Key several times in the Initial Setting Level to display $AM\overline{OV}$ (Move to Advanced Function Setting Level).</p>	<p>Initial Setting Level</p>  <p>Input Type</p>
<p>3 Press the $\overline{\text{CPL}}$ and $\overline{\text{CPL}}$ Keys at the Move to Advanced Function Setting Level parameter and then enter -169. * You can hold the $\overline{\text{CPL}}$ (Up) or $\overline{\text{CPL}}$ (Down) Key to increment or decrement the set value quickly.</p>	<p>Initial Setting Level</p>  <p>Move to Advanced Function Setting Level</p>
<p>4 Press $\overline{\text{CPL}}$ Key once or wait for 2 seconds or longer without doing anything. The display will change to the Advanced Function Setting Level.</p>	<p> Move to Advanced Function Setting Level -169: Password to move to Advanced Function Setting Level</p> <p>Advanced Function Setting Level</p>  <p>Parameter Initialization</p>

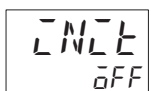
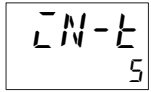
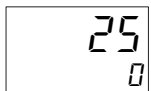
● Moving from the Advanced Function Setting Level to the Operation Level



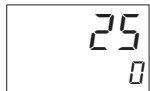

<p>1 Press the $\overline{\text{CPL}}$ Key for at least 1 second in the Advanced Function Setting Level. The display will change from the Advanced Function Setting Level to the Initial Setting Level.</p>	<p>Advanced Function Setting Level</p> 
<p>2 Press the $\overline{\text{CPL}}$ Key for at least 1 second in the Initial Setting Level. The display will change from the Initial Setting Level to the Operation Level.</p>	<p>Initial Setting Level</p>  <p>Input Type</p> <p>Operation Level</p>  <p>PV/SP</p>

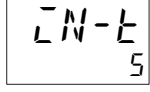
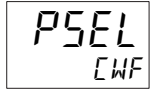
4-1-5 Moving to the Communications Setting Level

● Moving from the Operation Level to the Communications Setting Level

<p>1 Press the  Key for at least 3 seconds in the Operation Level. The No. 1 display will flash when the keys are pressed for 1 s or longer. The display will change from the Operation Level to the Initial Setting Level.</p>	<p>Operation Level</p> 
<p>2 Press the  Key for less than 1 second in the Initial Setting Level.</p> <p>The display will change from the Initial Setting Level to the Communications Setting Level.</p>	<p>Initial Setting Level</p>  Input Type <p>Communications Setting Level</p>  Protocol Setting

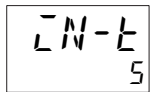
● Moving from the Communications Setting Level to the Operation Level

<p>1 Press the  Key for less than 1 second in the Communications Setting Level. The display will change from the Communications Setting Level to the Initial Setting Level.</p>	<p>Communications Setting Level</p> 
<p>2 Press the  Key for at least 1 second in the Initial Setting Level.</p> <p>The display will change from the Initial Setting Level to the Operation Level.</p>	<p>Initial Setting Level</p>  Input Type <p>Operation Level</p>  PV/SP

4-2 Initial Setting Examples

Initial hardware setup, including the sensor input type, alarm types, control periods, and other settings, is done using parameter displays. The and Keys are used to switch between parameters, and the amount of time that you press the keys determines which parameter you move to. This section describes two typical examples.

Explanation of Examples

Changing Parameters

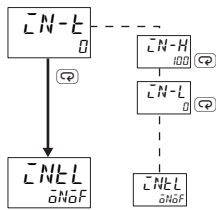

A image means that there are parameters. Continue pressing the Key to change parameters until you reach the intended parameter.

Changing Numbers

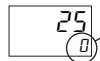

Numeric data and selections in each screen can be changed by using the and Keys.

Example 1

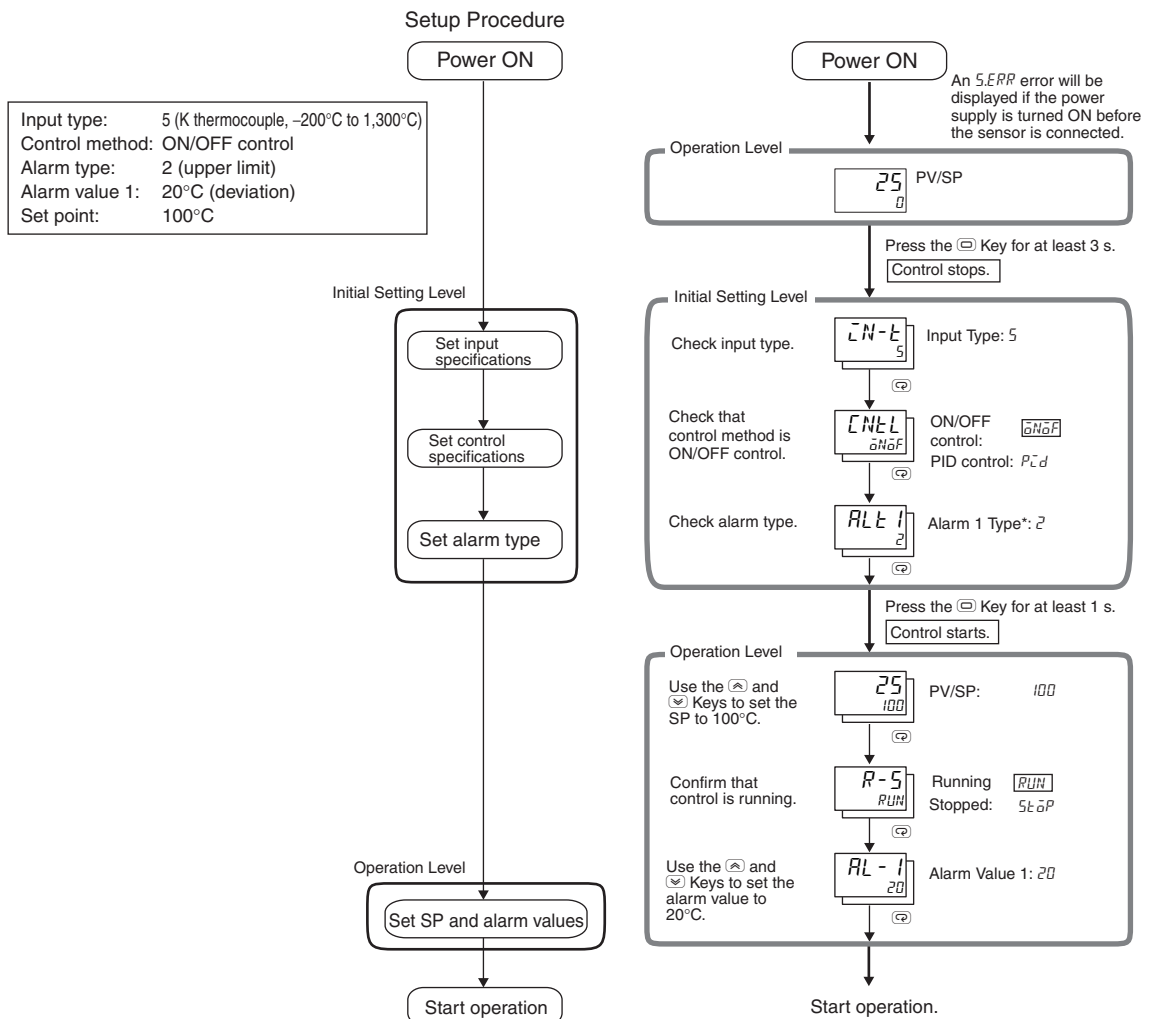

* If the Controller is equipped with HB/HS alarm detection, the Alarm 1 Type is not displayed for the default settings. To use alarm 1, set an output assignment to alarm 1. For details, refer to 4-6-3 Assigned Output Functions.

Example 2

Input type: 9 (T thermocouple, -200°C to 400°C)
 Control method: PID control
 PID constants found using auto-tuning (AT).
 Alarm type: 2 (upper limit)
 Alarm value 1: 30°C
 Set point: 150°C

Setup Procedure

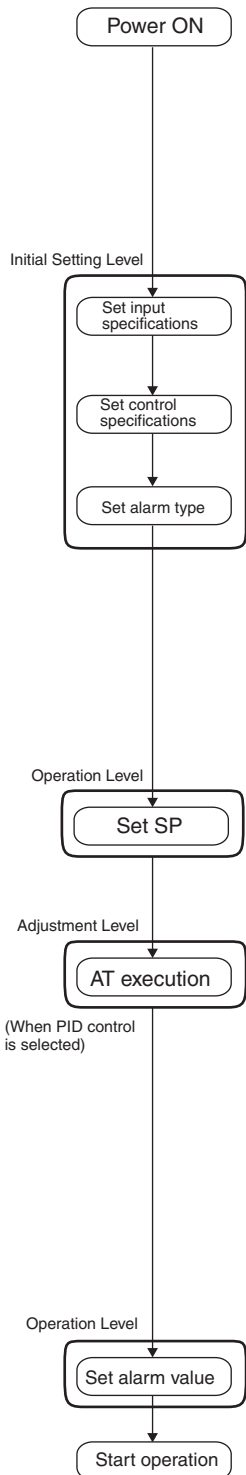

(When PID control is selected)

* If the Controller is equipped with HB/HS alarm detection, the Alarm 1 Type is not displayed for the default settings. To use alarm 1, set an output assignment to alarm 1. For details, refer to 4-6-3 Assigned Output Functions.

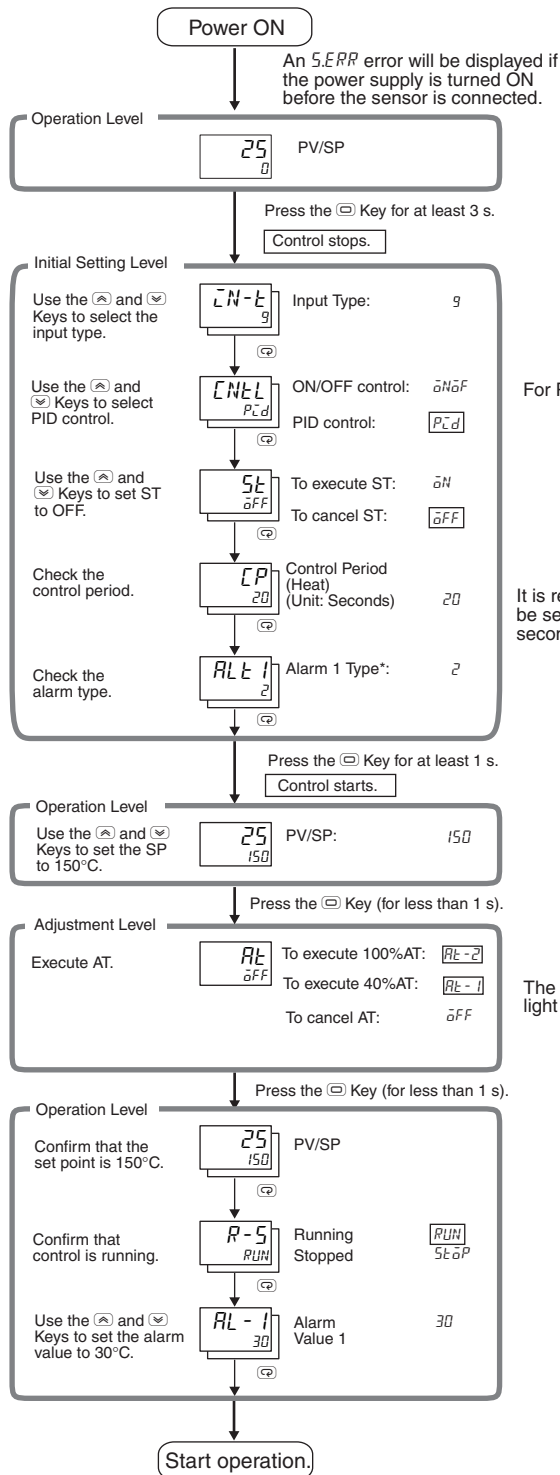

For PID, set $P_c d$.

It is recommended that 20 seconds be set for a relay output and 2 seconds for an SSR voltage output.

The TUNE indicator will light during autotuning.



4-3 Setting the Input Type

The Controller supports four input types: resistance thermometer, thermocouple, infrared temperature sensor, and analog inputs. Set the input type that matches the sensor that is used.

4-3-1 Input Type



The following example shows how to set a K thermocouple for -20.0 to 500.0°C (input type 6).

Operating Procedure

<p>1 Press the  Key for at least 3 seconds to move from the Operation Level to the Initial Setting Level. The $\bar{L}N-E$ (Input Type) parameter will be displayed.</p>	<p>Initial Setting Level</p> <div style="border: 1px solid black; padding: 5px; display: inline-block;"> $\bar{L}N-E$ 5 </div> <p>Input Type</p>
<p>2 Press the  or  Key to select 6 (K thermocouple at -20.0 to 500.0°C). The default is 5 (5: K thermocouple at -200 to $1,300^{\circ}\text{C}$).</p>	<div style="border: 1px solid black; padding: 5px; display: inline-block;"> $\bar{L}N-E$ 6 </div>



Additional Information

Changes that are made with key operations are applied when the  or  Key is pressed. They are also applied if you do nothing for 3 seconds or longer.

List of Input Types

	Specifications	Set value	Temperature range in °C	Temperature range in °F
Resistance thermometer	Pt100	0	-200 to 850	-300 to 1500
		1	-199.9 to 500.0	-199.9 to 900.0
		2	0.0 to 100.0	0.0 to 210.0
	JPt100	3	-199.9 to 500.0	-199.9 to 900.0
		4	0.0 to 100.0	0.0 to 210.0
Thermocouple	K	5	-200 to 1300	-300 to 2300
		6	-20.0 to 500.0	0.0 to 900.0
	J	7	-100 to 850	-100 to 1500
		8	-20.0 to 400.0	0.0 to 750.0
	T	9	-200 to 400	-300 to 700
		10	-199.9 to 400.0	-199.9 to 700.0
	E	11	-200 to 600	-300 to 1100
	L	12	-100 to 850	-100 to 1500
	U	13	-200 to 400	-300 to 700
		14	-199.9 to 400.0	-199.9 to 700.0
	N	15	-200 to 1300	-300 to 2300
	R	16	0 to 1700	0 to 3000
	S	17	0 to 1700	0 to 3000
	B	18	100 to 1800	300 to 3200
W	19	0 to 2300	0 to 3200	
PLII	20	0 to 1300	0 to 2300	
Infrared temperature sensor ES1B	10 to 70°C	21	0 to 90	0 to 190
	60 to 120°C	22	0 to 120	0 to 240
	115 to 165°C	23	0 to 165	0 to 320
	140 to 260°C	24	0 to 260	0 to 500
Current output	4 to 20 mA	25	One of the following ranges according to the scaling: -1999 to 9999 -199.9 to 999.9 -19.99 to 99.99 -1.999 to 9.999	
	0 to 20 mA	26		
Voltage input	1 to 5 V	27		
	0 to 5 V	28		
	0 to 10 V	29		

The default is 5.



Precautions for Correct Use

S.ERR (S.ERR: input error) flashes on the display if a sensor is not connected or if the connected sensor is different from input type. Connect a sensor if one is not already connected.

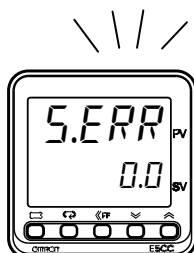



4-4 Selecting the Temperature Unit

4-4-1 Temperature Unit

- Either °C or °F can be selected as the temperature unit.
- Set the temperature unit in the Temperature Unit (*d-U*) parameter of the Initial Setting Level. The default is $\bar{\square}$ (°C).
The following procedure selects °C.

Operating Procedure

<p>1 Press the  Key several times in the Initial Setting Level to display <i>d-U</i> (Temperature Unit).</p>	<p>Initial Setting Level</p> <div style="border: 1px solid black; padding: 5px; display: inline-block;"> $d-U$ $\bar{\square}$ </div> <p>Temperature Unit</p>
<p>2 Press the  or  Key to select °C. The default is $\bar{\square}$ (°C). $\bar{\square}$: °C, <i>F</i>: °F</p>	<div style="border: 1px solid black; padding: 5px; display: inline-block;"> $d-U$ $\bar{\square}$ </div>

4-5 Selecting PID Control or ON/OFF Control

Two control methods are supported: 2-PID control and ON/OFF control. Switching between 2-PID control and ON/OFF control is executed by means of the PID ON/OFF parameter in the initial setting level. When this parameter is set to $P\bar{L}d$, 2-PID control is selected, and when set to $\bar{a}N\bar{a}F$, ON/OFF control, is selected. The default is $\bar{a}N\bar{a}F$.

● 2-PID Control

PID control is set by AT (auto-tuning), ST (self-tuning), or manual setting.

For PID control, set the PID constants in the Proportional Band (P), Integral Time (\bar{I}), and Derivative Time (d) parameters.

For heating and cooling control, also set the Proportional Band (Cooling) ($\bar{I}-P$), Integral Time (Cooling) ($\bar{I}-\bar{I}$), and Derivative Time (Cooling) ($\bar{I}-d$).

● ON/OFF Control

In ON/OFF control, the control output is turned ON when the process value is lower than the current set point, and the control output is turned OFF when the process value is higher than the current set point (reverse operation).

4-6 Setting Output Specifications

4-6-1 Control Periods

 Control Period (Heating)

 Control Period (Cooling)

- Set the output periods (control periods). Though a shorter period provides better control performance, it is recommended that the control period be set to 20 seconds or longer for a relay output to preserve the service life of the relay. After the settings have been made in the initial setup, readjust the control period, as required, by means such as trial operation.
- Set the control periods in the Control Period (Heating) and Control Period (Cooling) parameters in the Initial Setting Level. The default is 20 seconds for a relay output and 2 seconds for a voltage output (for driving SSR).
- The control periods are used only for PID control.
- The Control Period (Cooling) parameter is used only for heating/cooling control.
- When control output is used as a current output, the Control Period parameter cannot be used.

4-6-2 Direct and Reverse Operation

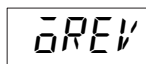

- Direct operation increases the manipulated variable whenever the process value increases. Reverse operation decreases the manipulated variable whenever the process value increases.

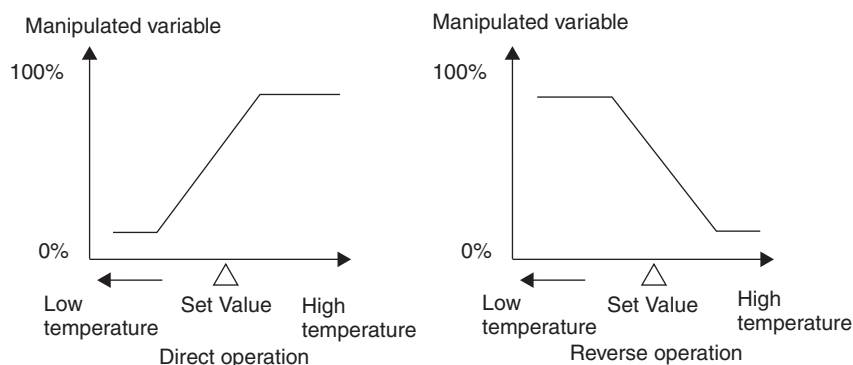

For example, when the process value (PV) is lower than the set point (SP) in a heating control system, the manipulated variable increases according to the difference between the PV and SP. Accordingly, reverse operation is used in a heating control system. Direct operation is used in a cooling control system, in which the operation is the opposite of a heating control system. The Control Output 1 Assignment is set to \bar{a} (control output (heating)) for either direct or reverse operation.

- Direct/reverse operation is set in the Direct/Reverse Operation parameter in the Initial Setting Level. The default is $\bar{a}^R - R$ (reverse operation).



In this example, direct/reverse operation, and control period (heating) parameters are checked.

Direct/reverse operation = $\bar{a}R-R$ (reverse operation)



Control period (heating) = 20 (seconds)

Operating Procedure

- Setting the Control Period (Heating) Parameter

<p>1 Press the  Key several times in the Initial Setting Level to display CP (Control Period (Heating)).</p>	<p>Initial Setting Level</p> <div style="border: 1px solid black; padding: 5px; display: inline-block;"> CP 20 </div> <p>Control Period (Heating)</p>
<p>2 Press the  or  Key to set the value to 20. The default for a relay output is 20 seconds.</p>	<div style="border: 1px solid black; padding: 5px; display: inline-block;"> CP 20 </div>

- Setting Direct/Reverse Operation

<p>1 Press the  Key several times in the Initial Setting Level to display $\bar{a}REV$ (Direct/Reverse Operation).</p>	<p>Initial Setting Level</p> <div style="border: 1px solid black; padding: 5px; display: inline-block;"> $\bar{a}REV$ $\bar{a}R-R$ </div> <p>Direct/Reverse Operation</p>
<p>2 Press the  or  Key to select $\bar{a}R-R$ (Reverse Operation). The default is $\bar{a}R-R$ (Reverse Operation).</p>	<div style="border: 1px solid black; padding: 5px; display: inline-block;"> $\bar{a}REV$ $\bar{a}R-R$ </div>

4-6-3 Assigned Output Functions

- Function assignments can be changed by changing the settings for control and auxiliary output assignments.
- The default function assignments for each output are shown below.

Parameter name	Display	Initial status
Control Output 1 Assignment	$\bar{a}Ut 1$	Control output (heating)
Control Output 2 Assignment	$\bar{a}Ut 2$	Not assigned.
Auxiliary Output 1 Assignment	$Sub 1$	Alarm 1*
Auxiliary Output 2 Assignment	$Sub 2$	Alarm 2
Auxiliary Output 3 Assignment	$Sub 3$	Alarm 3
Auxiliary Output 4 Assignment (E5EC only)	$Sub 4$	Alarm 4

- Refer to page 6-73 for the functions that can be assigned to the outputs.
- Each output is automatically initialized as shown below by changing the control mode between standard and heating/cooling.

Assigned Output Functions

Controllers with Three or Fewer Auxiliary Outputs

Parameter name	Display	Without control output 2		With control output 2	
		Standard	Heating/cooling	Standard	Heating/cooling
Control Output 1 Assignment	<i>OUT 1</i>	Control output (heating)	Control output (heating)	Control output (heating)	Control output (heating)
Control Output 2 Assignment	<i>OUT 2</i>	---	---	Not assigned.	Control output (cooling)
Auxiliary Output 1 Assignment	<i>SUB 1</i>	Alarm 1*	Alarm 1*	Alarm 1*	Alarm 1*
Auxiliary Output 2 Assignment	<i>SUB 2</i>	Alarm 2	Control output (cooling)	Alarm 2	Alarm 2
Auxiliary Output 3 Assignment	<i>SUB 3</i>	Alarm 3	Alarm 3	Alarm 3	Alarm 3

Controllers with Four Auxiliary Outputs

Parameter name	Display	Without control output 2		With control output 2	
		Standard	Heating/cooling	Standard	Heating/cooling
Control Output 1 Assignment	<i>OUT 1</i>	Control output (heating)	Control output (heating)	Control output (heating)	Control output (heating)
Control Output 2 Assignment	<i>OUT 2</i>	---	---	Not assigned.	Control output (cooling)
Auxiliary Output 1 Assignment	<i>SUB 1</i>	Alarm 1*	Alarm 1*	Alarm 1*	Alarm 1*
Auxiliary Output 2 Assignment	<i>SUB 2</i>	Alarm 2	Alarm 2	Alarm 2	Alarm 2
Auxiliary Output 3 Assignment	<i>SUB 3</i>	Alarm 3	Alarm 3	Alarm 3	Alarm 3
Auxiliary Output 4 Assignment	<i>SUB 4</i>	Alarm 4	Control output (cooling)	Alarm 4	Alarm 4

- * If the Controller is equipped with HB/HS alarm detection, it is set by default to detect heater alarms (HA). Therefore, the alarm 1 function is disabled and the Alarm 1 Type is not displayed. To enable alarm 1, set an output assignment to alarm 1. If the Program Pattern parameter is changed to a setting other than OFF, Auxiliary Output 1 Assignment parameter is set as the program end output.

● Alarms

It will be specified in this section when an alarm must be assigned, i.e., when an alarm must be set for the Control Output 1 or 2 Assignment parameters, or for the Auxiliary Output 1 to 4 Assignment parameters. For example, if alarm 1 is set for the Control Output 1 Assignment parameter, then alarm 1 has been assigned.

Assigning a work bit to either control output 1 or 2 or to auxiliary output 1 to 4 is also considered to be the same as assigning an alarm. For example, if work bit 1 is set for the Auxiliary Output 1 Assignment parameter, then alarms 1 to 4 have been assigned.

Assign the control outputs and auxiliary outputs.

Control output 1: Control output (heating)



Control output 2: Control output (cooling)

Auxiliary output 1: Alarm 1

Auxiliary output 2: Alarm 2

Operating Procedure

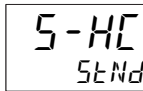
- Setting Heating/Cooling Control

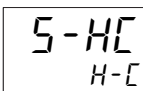
<p>1 Press the  Key several times in the Initial Setting Level to display 5-HC (Standard or Heating/Cooling).</p>	<p>Initial Setting Level</p>  <p>Standard or Heating/Cooling</p>
<p>2 Press the  or  Key to set the parameter to H-C. The default is 5tNd (standard).</p>	

* Use the following procedures to check the output assignments. The output assignments are changed automatically when you change between standard and heating/cooling control. You do not have to set them.

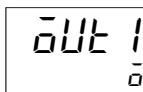
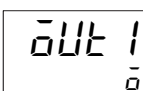

- Setting Control Output 1

<p>1 Press the  Key several times in the Advanced Function Setting Level to display out 1 (Control Output 1 Assignment).</p>	<p>Advanced Function Setting Level</p>  <p>Control Output 1 Assignment</p>
<p>2 Set the parameter to a (Control Output (Heating)). The default is a (Control Output (Heating)).</p>	

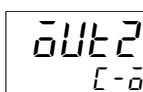
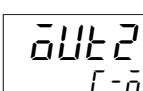

- Setting Control Output 2

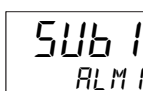
<p>1 Press the  Key several times in the Advanced Function Setting Level to display out 2 (Control Output 2 Assignment).</p>	<p>Advanced Function Setting Level</p>  <p>Control Output 2 Assignment</p>
<p>2 Set the parameter to L-a (Control Output (Cooling)). As soon as you select H-C (Heating/Cooling) for the Standard or Heating/Cooling parameter, the setting of this parameter is automatically changed to L-a (Control Output (Cooling)).</p>	

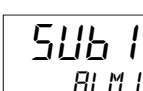
- Setting Auxiliary Output 1

<p>1 Press the  Key several times in the Advanced Function Setting Level to display Sub 1 (Auxiliary Output 1 Assignment).</p>	<p>Advanced Function Setting Level</p>  <p>Auxiliary Output 1 Assignment</p>
<p>2 Press the  or  Key to set the parameter to ALM 1. The default is ALM 1 (Alarm 1). If the Controller is equipped with HB/HS alarm detection, this parameter is set by default to HR (heater alarm).</p>	

- Setting Auxiliary Output 2

<p>1 Press the  Key several times in the Advanced Function Setting Level to display <i>SUB2</i> (Auxiliary Output 2 Assignment).</p>	<p>Advanced Function Setting Level</p> <div style="display: flex; align-items: center;"> <div style="border: 1px solid black; padding: 5px; margin-right: 10px;"> <p style="font-size: 1.2em; margin: 0;"><i>SUB2</i></p> <p style="font-size: 0.8em; margin: 0;"><i>ALM2</i></p> </div> <p style="margin: 0;">Auxiliary Output 2 Assignment</p> </div>
<p>2 Press the  or  Key to set the parameter to <i>ALM2</i>. The default is <i>ALM2</i> (Alarm 2).</p>	<div style="border: 1px solid black; padding: 5px;"> <p style="font-size: 1.2em; margin: 0;"><i>SUB2</i></p> <p style="font-size: 0.8em; margin: 0;"><i>ALM2</i></p> </div>

4-6-4 Auxiliary Output Opening or Closing in Alarm

- When "close in alarm" is set, the status of the auxiliary output is output unchanged. When "open in alarm" is set, the status of the auxiliary output function is reversed before being output.
- Each auxiliary output can be set independently.
- These settings are made in the Auxiliary Output 1 to 4 Open in Alarm parameters (Advanced Function Setting Level).
- The default is $N-\bar{a}$: Close in Alarm.

	Auxiliary output functions 1 to 4	Auxiliary output	Indicators (SUB1 to SUB4)
Close in Alarm ($N-\bar{a}$)	ON	ON	Lit
	OFF	OFF	Not lit
Open in Alarm ($N-L$)	ON	OFF	Lit
	OFF	ON	Not lit

- The alarm output will turn OFF (i.e., the relay contacts will open) when power is interrupted and for about two seconds after the power is turned ON regardless of the setting of the Auxiliary Output 1 to 4 Open in Alarm parameter.

4-7 Setting the Set Point (SP)

Operation Level

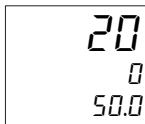

The Operation Level is displayed when the power is turned ON. For the default setting, the No. 1 display shows the PV, the No. 2 display shows the SP, and the No. 3 display (E5EC only) shows the MV.

The contents that is set in the PV/SP Display Screen Selection parameter in the Advanced Function Setting Level are displayed. For details, refer to 4-13-1 PV/SP Display Selections.

4-7-1 Changing the SP

- The set point cannot be changed when the Operation/Adjustment Protect parameter is set to 3. For details, refer to 5-7 Using the Key Protect Level.
- To change the set point, press the or Key in the PV/SP parameter (Operation Level) or for the SP/SP (character display) display in the Operation Level, and set the desired set value. The new set point is selected three seconds after you have specified the new value.
- Multi-SP is used to switch between eight set points. For details, refer to 5-4 Using Event Inputs for details.

In this example, the set point is changed from 0°C to 200°C.

Operating Procedure

- 1 Press the or Key in the Operation Level to set the SP to 200. The default SP is 0°C.

Operation Level

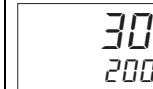

Additional Information

- If there are a lot of digits in a numeric value, you can use the (Shift Key) to select the digit to change before you change the value of the digit.

Example: Changing 1,000°C to 1,200°C

- 1 Press Key three times.
The third digit will flash.

Operation Level



- 2 Press the Key to set the value to 1200.

Operation Level

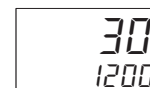

4-8 Using ON/OFF Control

In ON/OFF control, the control output turns OFF when the temperature being controlled reaches the preset set point. When the manipulated variable turns OFF, the temperature begins to fall and the control turns ON again. This operation is repeated over a certain temperature range. At this time, how much the temperature must fall before control turns ON again is determined by the Hysteresis (Heating) parameter. Also, what direction the manipulated variable must be adjusted in response to an increase or decrease in the process value is determined by the Direct/Reverse Operation parameter.

4-8-1 ON/OFF Control

- Switching between 2-PID control and ON/OFF control is performed using the PID ON/OFF parameter in the Initial Setting Level. When this parameter is set to $P\bar{L}d$, 2-PID control is selected, and when it is set to $\bar{a}N\bar{a}F$, ON/OFF control is selected. The default is $\bar{a}N\bar{a}F$.

● Hysteresis

- With ON/OFF control, hysteresis is used to stabilize operation when switching between ON and OFF. The control output (heating) and control output (cooling) functions are set in the Hysteresis (Heating) and Hysteresis (Cooling) parameters, respectively.
- In standard control (heating or cooling control), the setting of the Hysteresis (Heating) parameter in the Adjustment Level is used as the hysteresis regardless of whether the control type is heating control or cooling control.

Reverse operation

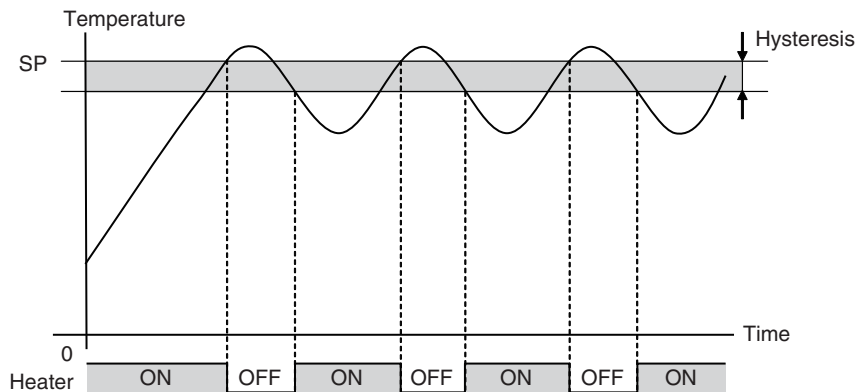

Parameters

Display	Parameter	Application	Level
S-HE	Standard or Heating/Cooling	Specifying control method	Initial Setting Level
ENEL	PID ON/OFF	Specifying control method	Initial Setting Level
OREV	Direct/Reverse Operation	Specifying control method	Initial Setting Level
E-db	Dead Band	Heating/cooling control	Adjustment Level
HYS	Hysteresis (Heating)	ON/OFF control	Adjustment Level
CHYS	Hysteresis (Cooling)	ON/OFF control	Adjustment Level

4-8-2 Settings

To execute ON/OFF control, set the Set Point, PID ON/OFF, and Hysteresis parameters.

Setting the PID ON/OFF Parameter

Confirm that the PID ON/OFF parameter is set to $\bar{a}N\bar{a}F$ in the Initial Setting Level.

Operating Procedure

- 1 Press the ☐ Key several times in the Initial Setting Level to display ENEL (PID ON/OFF).
The default is $\bar{a}N\bar{a}F$ (ON/OFF control).

Initial Setting Level

ENEL PID ON/OFF
 $\bar{a}N\bar{a}F$

Setting the SP

In this example, the set point is set to 200°C. The set value (i.e., the SP) is shown at the bottom of the display.

Operating Procedure

- 1 Select PV/SP in the Operation Level.
- 2 Press the ▲ or ▼ Key to set the SP to 200.
The default is 0.
The new set value can be saved by pressing the ☐ Key, or it will go into effect after 3 seconds has elapsed.

Operation Level





25 PV/SP
100

25
200

Setting the Hysteresis

Set the hysteresis to 2.0°C.

Operating Procedure

<p>1 Press the  Key several times in the Adjustment Level to display <i>HYS</i> (Hysteresis (Heating)).</p>	<p>Adjustment Level</p> <div style="border: 1px solid black; padding: 5px; display: inline-block;"> <p style="font-size: 1.2em; margin: 0;"><i>HYS</i></p> <p style="font-size: 0.8em; margin: 0;">1.0</p> </div> <p style="margin-left: 20px; font-size: 0.8em;">Hysteresis (Heating)</p>
<p>2 Press the  or  Key to set the hysteresis to 2.0. The default is 1.0. The new set value can be saved by pressing the  Key, or it will go into effect after 3 seconds has elapsed.</p>	<div style="border: 1px solid black; padding: 5px; display: inline-block;"> <p style="font-size: 1.2em; margin: 0;"><i>HYS</i></p> <p style="font-size: 0.8em; margin: 0;">2.0</p> </div>



4-9 Determining PID Constants (AT, ST, Manual Setup)

4-9-1 AT (Auto-tuning)

AT

- When AT is executed, the optimum PID constants for the set point at that time are set automatically. A method (called the limit cycle method) for forcibly changing the manipulated variable and finding the characteristics of the control object is employed.
- Either 40% AT or 100% AT can be selected depending on the width of MV variation in the limit cycle. In the AT Execute/Cancel parameter, specify $AT - 2$ (100% AT) or $AT - 1$ (40% AT). To cancel AT, specify OFF (AT cancel).
- Only 100% AT can be executed for heating and cooling control.
- If the Heating/Cooling Tuning Method parameter is set to any value other than 0 (same as heating control), the PID constants are set automatically for both heating control and cooling control.
- AT cannot be executed when control has stopped or during ON/OFF control.
- The results of autotuning are saved in the following parameters in the Adjustment Level: Proportional Band (P), Integral Time (I), Derivative Time (D), Proportional Band (Cooling) (C-P), Integral Time (Cooling) (C-I), and Derivative Time (Cooling) (C-D).

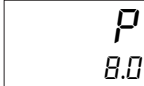
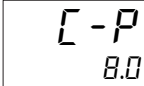
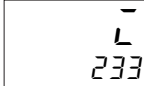
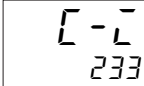
Adjustment Level

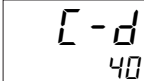
	Proportional Band		Proportional Band (Cooling)
	Integral Time		Integral Time (Cooling)
	Derivative Time		Derivative Time (Cooling)

● AT Operations

AT is started when either $AT - 2$ (100% AT) or $AT - 1$ (40% AT) is specified for the AT Execute/Cancel parameter.

The TUNE indicator will light during execution.

Only the Communications Writing, RUN/STOP, AT Execution/Cancel, and Program Start parameters can be changed during AT execution. Other parameters cannot be changed.

AT Calculated Gain

The AT Calculated Gain parameter sets the gain for when PID values are calculated using AT. When emphasizing response, decrease the set value. When emphasizing stability, increase the set value.

AT Hysteresis

The AT Hysteresis parameter sets the hysteresis when switching ON and OFF for the limit cycle operation during auto-tuning.

Limit Cycle MV Amplitude

The Limit Cycle MV Amplitude parameter sets the MV amplitude for limit cycle operation during auto-tuning.

* This setting is disabled for 100% AT.

● 40% AT

- The width of MV variation in the limit cycle can be changed in the Limit Cycle MV Amplitude parameter, but the AT execution time may be longer than for 100% AT. The limit cycle timing varies according to whether the deviation (DV) at the start of auto-tuning execution is less than 10% FS.

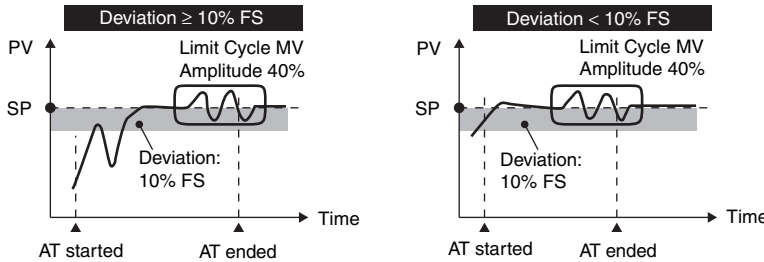

● 100% AT

- Operation will be as shown in the following diagram, regardless of the deviation (DV) at the start of AT execution. To shorten the AT execution time, select 100% AT.

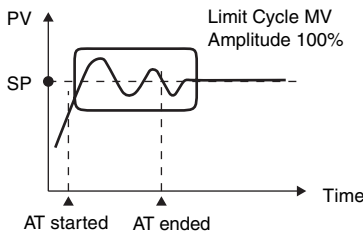

* The Limit Cycle MV Amplitude parameter is disabled.

This procedure executes 40%AT.

Operating Procedure

<p>1 Press the Key several times in the Adjustment Level to display AL (AT Execute/Cancel).</p>	<p>Adjustment Level</p> <div style="border: 1px solid black; padding: 5px; display: inline-block;"> AL OFF </div> <p>AT Execute/Cancel</p>
<p>2 Press the or Key to select AL - 1 (40% AT execute). * The TUNE indicator will light during autotuning.</p>	<div style="border: 1px solid black; padding: 5px; display: inline-block;"> AL AL - 1 </div>
<p>3 When AT ends, the AT Execute/Cancel parameter is set to OFF.</p>	<p>Adjustment Level</p> <div style="border: 1px solid black; padding: 5px; display: inline-block;"> AL OFF </div> <p>AT Execute/Cancel</p>

4-9-2 ST (Self-tuning)



ST (self-tuning) is a function that finds PID constants by using step response tuning (SRT) when Digital Controller operation begins or when the set point is changed.



Once the PID constants have been calculated, ST is not executed when the next control operation is started as long as the set point remains unchanged.

ST (self-tuning) is enabled when the ST parameter is set to ON in the Initial Setting Level.

When executing self-tuning, turn ON power for the load (e.g., heater) at the same time as or before supplying power to the Digital Controller. If power is turned ON for the Digital Controller before turning ON power for the load, self-tuning will not be performed properly and optimum control will not be achieved.

This procedure executes self-tuning (ST).

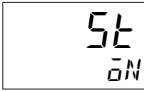
Operating Procedure

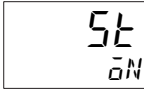
1 Press the  Key several times in the Initial Setting Level to display ST.	Initial Setting Level  ST
2 Press the  or  Key to select $\bar{O}N$ (ST ON). The default is ON. * The TUNE indicator will flash during ST execution.	



Additional Information

PID Constants

When control characteristics are already known, PID constants can be set directly to adjust control. The PID constants are set in the following parameters in the Adjustment Level: Proportional Band (P), Integral Time (I), Derivative Time (D), Proportional Band (Cooling) (C-P), Integral Time (Cooling) (C-I), and Derivative Time (Cooling) (C-D).

● Startup Conditions

Self-tuning by step response tuning (SRT) is started when the following conditions are met after program execution is started and the set point is changed.

At start of operation	When set point is changed
1. The set point at the start of operation differs from the set point when the previous SRT was executed. ^{*1} 2. The difference between the temperature at the start of operation and the set point is greater than the larger of the following two: (Present proportional band \times 1.27 + 4°C) and the ST stable range. 3. The temperature at the start of operation is lower than the set point during reverse operation, and is larger than the set point during direct operation. 4. There is no reset from input errors.	1. The new set point differs from the set point used when the previous SRT was executed. ^{*1} 2. The set point change width is greater than the larger of the following two: (Present proportional band \times 1.27 + 4°C) and the ST stable range. 3. During reverse operation, the new set point is larger than the set point before the change; and during direct operation, the new set point is smaller than the set point before the change. 4. The temperature is stable. ^{*2} (Equilibrium with the output amount at 0% when the power is turned ON is also all right.) ^{*3}

^{*1} The previous SRT-implemented set point is the set point that was used for calculating the PID constants for the previous SRT.

^{*2} In this state, the measurement point is within the ST stable range.

*3 In this state, the change width of the PV every 60 seconds is within the ST stable range or less.

In the following instances, PID constants are not changed by self-tuning (ST) for the present set point.

- (1) When the PID constants have been changed manually with ST set to ON.
- (2) When auto-tuning (AT) has been executed.



To execute self-tuning again after completing the above operations, set the ST parameter to OFF and then set it to ON again.

● ST Stable Range

The ST stable range determines the condition under which ST (self-tuning) functions.

This procedure sets the ST stable range to 20.0°C.

Operating Procedure

<p>1 Press the  Key several times in the Advanced Function Setting Level to display the ST Stable Range parameter.</p>	<p>Advanced Function Setting Level</p> <div style="border: 1px solid black; padding: 5px; display: inline-block;"> <p>St-b 15.0</p> </div> <p>ST Stable Range</p>
<p>2 Press the  or  Key to set the value to 20.0. The default is 15.0.</p>	<div style="border: 1px solid black; padding: 5px; display: inline-block;"> <p>St-b 20.0</p> </div>

RT (Robust Tuning)



- When AT or ST is executed with RT selected, PID constants are automatically set that make it hard for control performance to deteriorate even when the characteristics of the controlled object are changed.
- RT can be set in the Advanced Function Setting Level when PID control has been set.
- The RT mode cannot be selected while an analog input is set.
- Selecting the RT mode in the following cases will help to prevent hunting from occurring.
 - When the set temperature is not constant and is changed in a wide range
 - When there are large variations in ambient temperatures due to factors such as seasonal changes or differences between day and night temperatures
 - When there are large variations in ambient wind conditions and air flow
 - When heater characteristics change depending on the temperature
 - When an actuator with disproportional I/O, such as a phase-control-type power regulator, is used
 - When a rapidly heating heater is used
 - When the control object or sensor has much loss time
 - When hunting occurs in normal mode for any reason
 - * PID constants are initialized to the factory settings by switching to RT mode.
 - * When the RT mode is selected, the Integral/Derivative Time Unit parameter changes to 0.1 s.

● **RT Features**

- Even when hunting occurs for PID constants when AT or ST is executed in normal mode, it is less likely to occur when AT or ST is executed in RT mode.

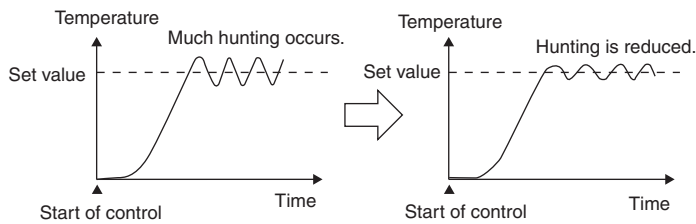

- When the temperature (PV) falls short of the set point for the PID constants when using AT or ST in normal mode, executing AT or ST in RT mode tends to improve performance.

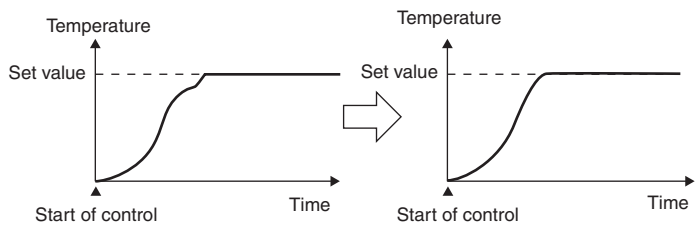

- When the manipulated variable (MV) is saturated, the amount of overshooting may be somewhat higher in comparison to PID control based on AT or ST in normal mode.

This procedure selects RT mode.

Operating Procedure

<p>1 Press the Key several times in the Advanced Function Setting Level to display <i>Rt</i> (RT: robust tuning).</p>	<p>Advanced Function Setting Level</p> <div style="border: 1px solid black; padding: 5px; display: inline-block;"> <i>Rt</i> RT OFF </div>
<p>2 Press the or Key to select <i>ON</i> (RT ON). The default is <i>OFF</i>.</p>	<div style="border: 1px solid black; padding: 5px; display: inline-block;"> <i>Rt</i> OFF <i>ON</i> </div>





4-9-3 Manual Setup

Individual PID constants can be manually set in the Proportional Band, Integral Time, and Derivative Time parameters in the Adjustment Level.



In this example, the Proportional Band parameter is set to 10.0, the Integral Time parameter to 250, and the Derivative Time parameter to 45.

Operating Procedure

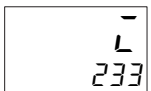

- Setting the Proportional Band

<p>1 Press the  Key several times in the Adjustment Level to display the Proportional Band parameter.</p>	<p>Adjustment Level</p> <div style="border: 1px solid black; padding: 5px; display: inline-block;">  </div> <p>Proportional Band</p>
<p>2 Press the  or  Key to set the value to 10.0.</p> <p>The default settings are as follows:</p> <ul style="list-style-type: none"> • Temperature input (°C or °F): 8.0 • Analog input (%FS): 10.0 	<div style="border: 1px solid black; padding: 5px; display: inline-block;">  </div>

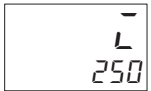
- Setting the Integral Time

<p>1 Press the  Key several times in the Adjustment Level to display the Integral Time parameter.</p>	<p>Adjustment Level</p> <div style="border: 1px solid black; padding: 5px; display: inline-block;">  </div> <p>Integral Time</p>
<p>2 Press the  or  Key to set the value to 250.</p> <p>The default settings are as follows:</p> <ul style="list-style-type: none"> • Integral/Derivative Time Unit of 1 s: 233 • Integral/Derivative Time Unit of 0.1 s: 233.0 	<div style="border: 1px solid black; padding: 5px; display: inline-block;">  </div>

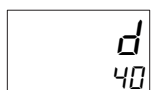
- Setting the Derivative Time

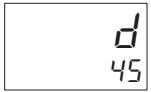
<p>1 Press the  Key several times in the Adjustment Level to display the Derivative Time parameter.</p>	<p>Adjustment Level</p> <div style="border: 1px solid black; padding: 5px; display: inline-block;">  </div> <p>Derivative Time</p>
<p>2 Press the  or  Key to set the value to 45.</p> <p>The default settings are as follows:</p> <ul style="list-style-type: none"> • Integral/Derivative Time Unit of 1 s: 40 • Integral/Derivative Time Unit of 0.1 s: 40.0 	<div style="border: 1px solid black; padding: 5px; display: inline-block;">  </div>



Additional Information

Proportional Action

When PID constants I (integral time) and D (derivative time) are set to 0, control is executed according to proportional action. As the default, the center value of the proportional band becomes the set point.

Related parameter: Manual Reset Value (Adjustment Level)

When P (Proportional Band) Is Adjusted

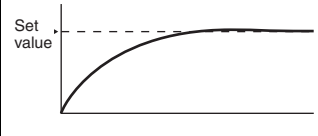
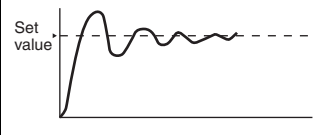
Increased		The curve rises gradually, and a long stabilization time is created, but overshooting is prevented.
Decreased		Overshooting and hunting occur, but the set value is quickly reached and the temperature stabilizes.

When I (Integral Time) Is Adjusted

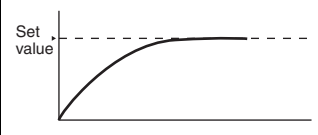
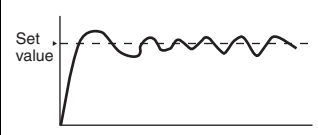
Increased		It takes a long time to reach the set point. It takes time to achieve a stable state, but overshooting, undershooting, and hunting are reduced.
Decreased		Overshooting and undershooting occur. Hunting occurs. The Controller starts up faster.

When D (Derivative Time) Is Adjusted

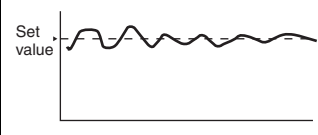
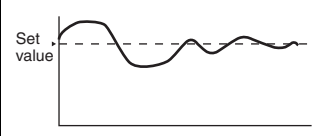
Increased		Overshooting, undershooting, and stabilization times are reduced, but fine hunting occurs on changes in the curve itself.
Decreased		Overshooting and undershooting increase, and it takes time to return to the set point.

4-10 Alarm Outputs

- Alarms can be used on either two or three auxiliary outputs on the E5CC or on two or four auxiliary outputs on the E5EC. For relay outputs or voltage outputs (for driving SSRs), alarms can also be used by setting the Control Output 1 Assignment or Control Output 2 Assignment parameter to any of the alarms from alarm 1 to 4. The alarm output condition is determined by a combination of the alarm type, alarm value, alarm hysteresis, and the standby sequence. For details, refer to *4-11 Alarm Hysteresis*.
- This section describes the Alarm Type, Alarm Value, Upper-limit Alarm and Lower-limit Alarm parameters.

4-10-1 Alarm Types

AL1 Alarm 1 Type

AL2 Alarm 2 Type

AL3 Alarm 3 Type

AL4 Alarm 4 Type

- Select one of the following eight alarm types for the alarm 1 type: Deviation, deviation range, absolute value, LBA, PV change rate, SP, MV, or RSP alarm.
- Select one of the following seven alarm types for the alarm 2 type, alarm 3 type, and alarm 4 type: Deviation, deviation range, absolute value, PV change rate, SP, MV, or RSP alarm. Alarm type 12 (LBA: loop burnout alarm) cannot be selected.

Set value	Alarm type	Alarm output operation		Description of function
		When alarm value X is positive	When alarm value X is negative	
0	Alarm function OFF	Output OFF		No alarm
1	Upper- and lower-limit*1		*2	Set the upward deviation in the set point for the alarm upper limit (H) and the lower deviation in the set point for the alarm lower limit (L). The alarm is ON when the PV is outside this deviation range.
2	Upper-limit			Set the upward deviation in the set point by setting the alarm value (X). The alarm is ON when the PV is higher than the SP by the deviation or more.
3	Lower-limit			Set the downward deviation in the set point by setting the alarm value (X). The alarm is ON when the PV is lower than the SP by the deviation or more.

Set value	Alarm type	Alarm output operation		Description of function
		When alarm value X is positive	When alarm value X is negative	
4	Upper- and lower-limit range*1		*3	Set the upward deviation in the set point for the alarm upper limit (H) and the lower deviation in the set point for the alarm lower limit (L). The alarm is ON when the PV is inside this deviation range.
5	Upper- and lower-limit with standby sequence*1		*4	A standby sequence is added to the upper- and lower-limit alarm (1).*6
6	Upper-limit with standby sequence			A standby sequence is added to the upper-limit alarm (2).*6
7	Lower-limit with standby sequence			A standby sequence is added to the lower-limit alarm (3).*6
8	Absolute-value upper-limit			The alarm will turn ON if the process value is larger than the alarm value (X) regardless of the set point.
9	Absolute-value lower-limit			The alarm will turn ON if the process value is smaller than the alarm value (X) regardless of the set point.
10	Absolute-value upper-limit with standby sequence			A standby sequence is added to the absolute-value upper-limit alarm (8).*6
11	Absolute-value lower-limit with standby sequence			A standby sequence is added to the absolute-value lower-limit alarm (9).*6
12	LBA (alarm 1 type only)			*7
13	PV change rate alarm			*8
14	SP absolute-value upper-limit alarm			This alarm type turns ON the alarm when the set point (SP) is higher than the alarm value (X).
15	SP absolute-value lower-limit alarm			This alarm type turns ON the alarm when the set point (SP) is lower than the alarm value (X).
16	MV absolute-value upper-limit alarm*9	Standard Control		This alarm type turns ON the alarm when the manipulated variable (MV) is higher than the alarm value (X).
		Heating/Cooling Control (Heating MV)		
		Heating/Cooling Control (Cooling MV)	Always ON	

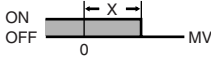
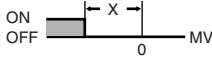
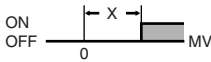
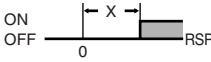
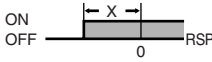
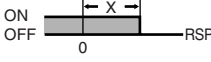
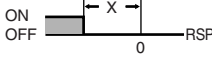
Set value	Alarm type	Alarm output operation		Description of function
		When alarm value X is positive	When alarm value X is negative	
17	MV absolute-value lower-limit alarm*9	Standard Control 	Standard Control 	This alarm type turns ON the alarm when the manipulated variable (MV) is lower than the alarm value (X).
		Heating/Cooling Control (Cooling MV) 	Heating/Cooling Control (Cooling MV) Always ON	
18	RSP absolute-value upper-limit alarm*10			This alarm type turns ON the alarm when the remote SP (RSP) is higher than the alarm value (X).
19	RSP absolute-value lower-limit alarm*10			This alarm type turns ON the alarm when the remote SP (RSP) is lower than the alarm value (X).

*1 With set values 1, 4, and 5, the upper- and lower-limit values can be set independently for each alarm type, and are expressed as “L” and “H.”

*2 Set value: 1 (Upper- and lower-limit alarm)

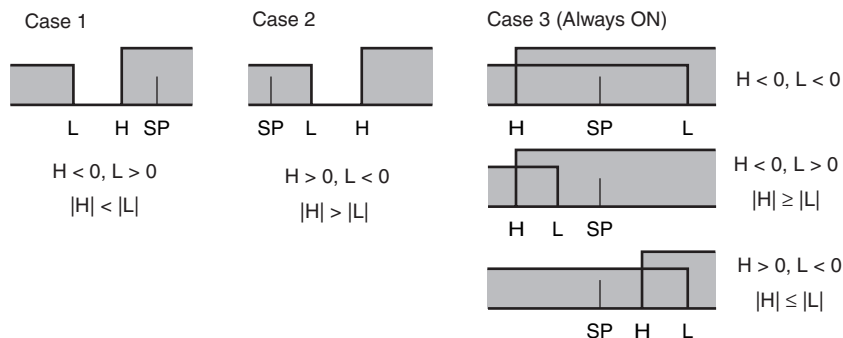

*3 Set value: 4 (Upper- and lower-limit range)

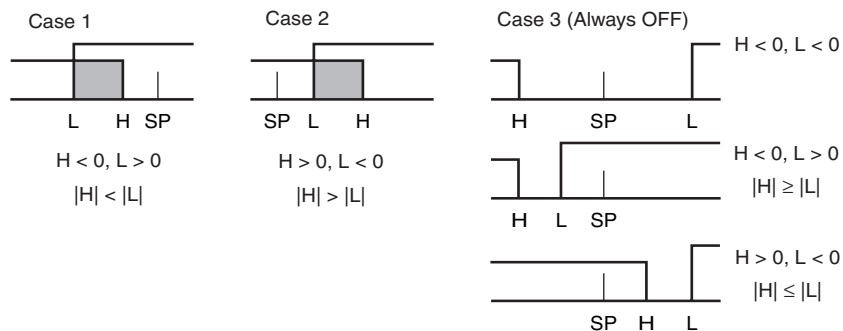

*4 Set value: 5 (Upper- and lower-limit with standby sequence)

- For the upper- and lower-limit alarms in cases 1 and 2 above, the alarm is always OFF if upper- and lower-limit hysteresis overlaps.
- In case 3, the alarm is always OFF.

*5 Set value: 5 (Upper- and lower-limit with standby sequence)

- The alarm is always OFF if upper- and lower-limit hysteresis overlaps.

*6 Refer to *Standby Sequence Reset* on page 6-57 for information on the operation of the standby sequence.

*7 Refer to *Loop Burnout Alarm (LBA) (Valid only for alarm 1.)* on page 3-17.

*8 Refer to *PV change rate alarm* on page 3-18.

*9 When heating/cooling control is performed, the MV absolute-value upper-limit alarm functions only for the heating operation and the MV absolute-value lower-limit alarm functions only for the cooling operation.

- *10 This value is displayed only when a remote SP input is used. It functions in both Local SP Mode and Remote SP Mode.
- Set the alarm type independently for each alarm in the Alarm 1 to 4 Type parameters in the Initial Setting Level. The default is 2 (Upper-limit alarm).
 - If the Controller is equipped with HB/HS alarm detection, the Alarm 1 Type is not displayed for the default settings. To use alarm 1, set an output assignment to alarm 1. (Refer to *4-6-3 Assigned Output Functions*.)

4-10-2 Alarm Values

 Alarm Lower Limit Value

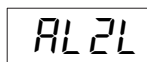

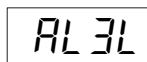

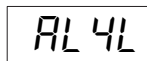

 Alarm Upper Limit Value

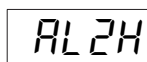

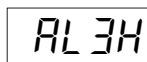

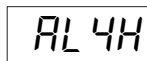

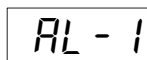
 Alarm Value

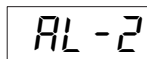

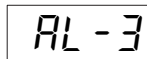

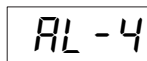

- Alarm values are indicated by “X” in the table on the previous page. When the upper and lower limits are set independently, “H” is displayed for upper limit values, and “L” is displayed for lower limit values.
- To set the alarm value upper and lower limits for deviation, set the upper and lower limits in each of the Alarm 1 to 4 Upper Limit, and Alarm 1 to 4 Lower Limit parameters in the Operation Level.



This procedure sets alarm 1 as an upper-limit alarm. The alarm is output when the process value (PV) exceeds the set point (SP) by 10°C. (In this example, the temperature unit is °C.)

Alarm 1 type = 2 (Upper-limit alarm)

Alarm value 1= 10

Operating Procedure

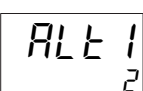
- Selecting the Alarm 1 Type

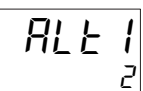
<p>1 Press the  Key several times in the Initial Setting Level to display <i>ALt 1</i> (Alarm 1 Type).*</p>	<p>Initial Setting Level</p>  Alarm 1 Type
<p>2 Press the  or  Key to set the set value to 2. The default is 2 (upper-limit alarm).</p>	

- Setting the Alarm Value

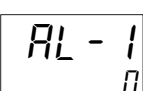
<p>1 Press the  Key several times in the Operation Level to display <i>AL - 1</i> (Alarm Value 1).</p>	<p>Operation Level</p>  Alarm Value 1
--	--

2 Press the or Key to set the set value to 10.
The default is 10.

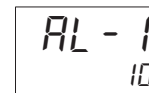

* If the Controller is equipped with HB/HS alarm detection, the Alarm 1 Type is not displayed for the default settings. To use alarm 1, set an output assignment to alarm 1. For details, refer to 4-6-3 Assigned Output Functions.

● PV Change Rate Alarm

The change width can be found for PV input values in any set period. Differences with previous values in each set period are calculated, and an alarm is output if the result exceeds the alarm value. The PV rate of change calculation period can be set in units of 50 ms.

If a positive value is set for the alarm value, the PV will operate as a change rate alarm in the rising direction. If a negative value is set, the PV will operate as a change rate alarm in the falling direction.

Precautions for Correct Use

If a shorter PV rate of change calculation period is set, outputs set for the PV change rate alarm function may repeatedly turn ON and OFF for a short period of time. It is therefore recommended that the PV change rate alarm be used with the alarm latch turned ON.

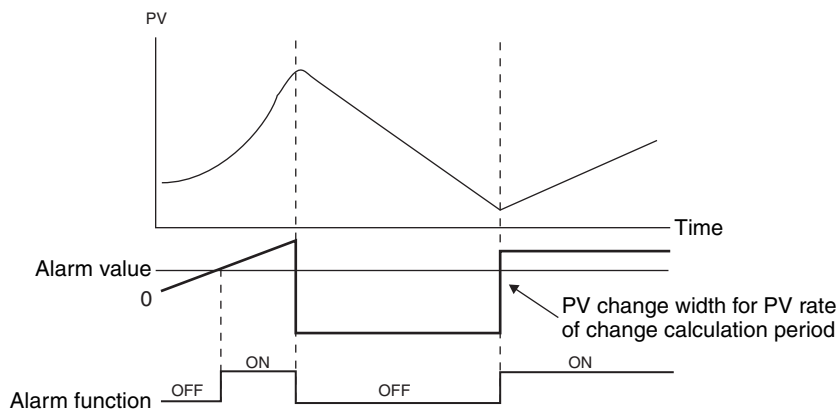

Parameter name	Setting range	Unit	Default
PV Rate of Change Calculation Period	1 to 999	Sampling cycle	20 (1 s)

● SP Alarms

You can set an upper-limit or lower-limit alarm for the set point (SP).

The alarm point is set in the corresponding alarm value parameter. The Alarm SP Selection parameter is used to specify the alarm for either the ramp SP or the target SP.

The corresponding alarm hysteresis setting is also valid.

SP absolute-value upper-limit alarm	SP absolute-value lower-limit alarm
<p>Example:</p> <p>Upper-limit alarm point (e.g., 100°C)</p> <p>Alarm value (e.g., 100°C)</p> <p>The alarm output is ON while the SP is equal to or higher than the set value.</p>	<p>Example:</p> <p>Lower-limit alarm point (e.g., 100°C)</p> <p>Alarm value (e.g., 100°C)</p> <p>The alarm output is ON while the SP is equal to or lower than the set value.</p>

● **MV Alarms**

You can set an upper-limit or lower-limit alarm for the manipulated value (MV).

The alarm point is set in the corresponding alarm value parameter. The corresponding alarm hysteresis setting is also valid.

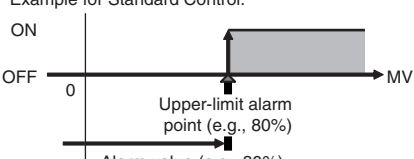
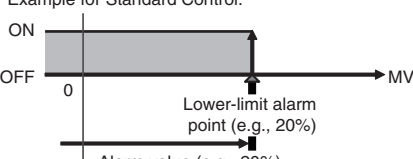
MV absolute-value upper-limit alarm	MV absolute-value lower-limit alarm
<p>Example for Standard Control:</p>  <p>The alarm output is ON while the MV is equal to or higher than the set value.</p>	<p>Example for Standard Control:</p>  <p>The alarm output is ON while the MV is equal to or lower than the set value.</p>

● **RSP Alarms**

You can set an upper-limit or lower-limit alarm for the remote SP input.

The alarm point is set in the corresponding alarm value parameter. The corresponding alarm hysteresis setting is also valid.

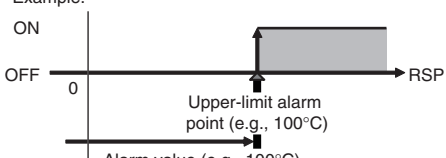
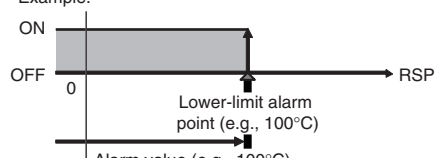
RSP absolute-value upper-limit alarm	RSP absolute-value lower-limit alarm
<p>Example:</p>  <p>The alarm output is ON while the remote SP is equal to or higher than the set value.</p>	<p>Example:</p>  <p>The alarm output is ON while the remote SP is equal to or lower than the set value.</p>

4-11 Alarm Hysteresis

- The hysteresis of alarm outputs when alarms are switched ON/OFF can be set as follows:

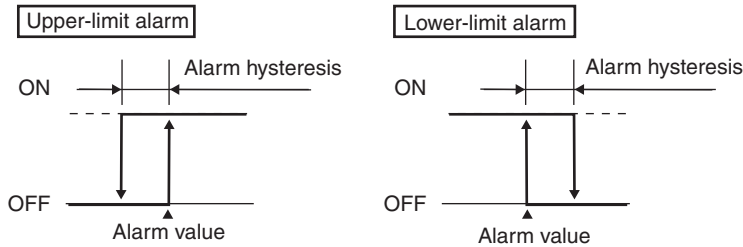

- Alarm hysteresis is set independently for each alarm in the Alarm Hysteresis 1 to Alarm Hysteresis 4 parameters (Initial Setting Level).
- For all alarms except for MV alarms, the default is 0.2 (°C/°F) for temperature inputs and 0.02% FS for analog inputs. The default is 0.50(%) for MV alarms.

4-11-1 Standby Sequence

- The standby sequence can be used so that an alarm will not be output until the process value leaves the alarm range once and then enters it again.
 - For example, with a lower-limit alarm, the process value will normally be below the set point, i.e., within the alarm range, when the power supply is turned ON, causing an alarm to be output. If the lower-limit alarm with a standby sequence is selected, an alarm will not be output until the process value increases above the alarm set value, i.e., until it leaves the alarm range, and then falls back below the alarm set value.
- Restart**
 - The standby sequence is canceled when an alarm is output. It is, however, restarted later by the Standby Sequence Reset parameter (Advanced Function Setting Level). For details, refer to the Standby Sequence Reset parameter in *Section 6 Parameters*.

4-11-2 Alarm Latch

- The alarm latch can be used to keep the alarm output ON until the latch is canceled regardless of the temperature once the alarm output has turned ON.

Any of the following methods can be used to clear the alarm latch.

- Turn OFF the power supply. (The alarm latch is also cleared by switching to the Initial Setting Level, Communications Setting Level, Advanced Function Setting Level, or Calibration Level.)
- Use the PF Key.
- Use an event input.

For details on setting the PF Key, refer to *5-18 Setting the PF Key*. For details on setting events, refer to *5-4 Using Event Inputs*.

● Summary of Alarm Operation

The following figure summarizes the operation of alarms when the Alarm Type parameter is set to "lower-limit alarm with standby sequence" and "close in alarm" is set.

Alarm type: Lower-limit alarm with standby sequence

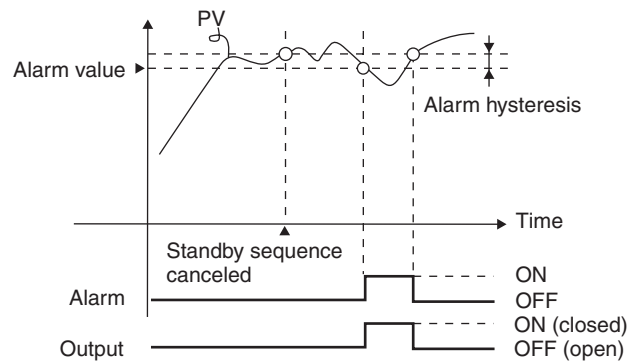

Parameters

Display	Parameter	Description	Level
<i>RLH*</i>	Alarm 1 to 4 Hysteresis	Alarm	Initial Setting Level
<i>RESE</i>	Standby Sequence	Alarm	Advanced Function Setting Level

* * = 1 to 4

4-12 Using Heater Burnout (HB) and Heater Short (HS) Alarms

4-12-1 HB Alarm

● What Is an HB Alarm?

A heater burnout alarm operates by detecting the heater current with a current transformer (CT) for time-proportional PID control or ON/OFF control. If the detected current is less than the specified heater burnout detection current even though the control output is ON, a heater burnout will be assumed and an alarm will be output.

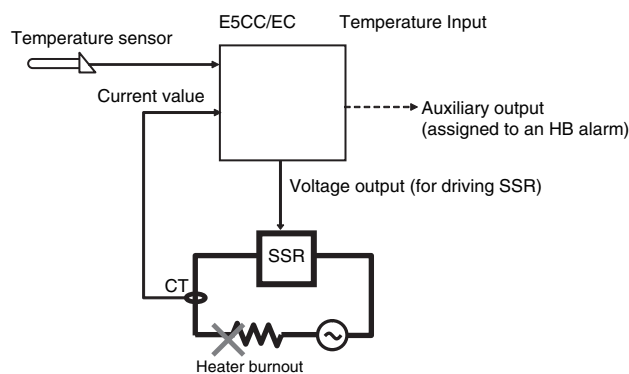

An HB alarm is separate from alarms 1 to 4.

The HB ON/OFF parameter and other parameters must be set in the Advanced Function Setting Level. With the default settings, the HB alarm is output on auxiliary output 1. You can use the output assignment parameters to change the output. You can use an integrated alarm to output an OR of alarms 1 to 4 and the other alarms. For details on the integrated alarm, refer to *5-9 OR Output of Alarms*.

● Parameters

Parameter	No. 1 display	Value	No. 2 display	Level
HB ON/OFF	<i>HbU</i>	OFF or ON (default: ON)	<i>oFF, oN</i>	Advanced Function Setting Level
Heater Burnout Latch	<i>HbL</i>	OFF or ON (default: OFF)	<i>oFF, oN</i>	Advanced Function Setting Level
Heater Burnout Hysteresis	<i>HbH</i>	0.1 to 50.0 A (default: 0.1 A)	0.1 to 50.0	Advanced Function Setting Level
Heater Burnout Detection 1 or 2 (alarm current)	<i>Hb1</i> <i>Hb2</i>	0.0 to 50.0 A (default: 0.0 A)	0.0 to 50.0	Adjustment Level
Heater Current 1 or 2 Value Monitor	<i>Et1</i> <i>Et2</i>	0.0 to 55.0 A	0.0 to 55.0	Adjustment Level
Auxiliary Output 1 to 4 Assignment	<i>Sub1</i> to <i>Sub4</i>	HB: HB alarm or HA: Heater alarm	<i>Hb</i> or <i>HA</i>	Advanced Function Setting Level

- A heater burnout is detected by measuring the heater current while the control output for heating is ON. (Heater burnout detection and heater short detection cannot be used with the control output for cooling.)

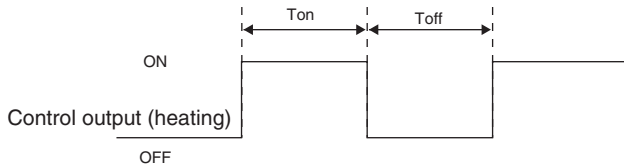

In the above diagram, power is considered to be ON (normal) if the heater current is greater than $Hb1$ or $Hb2$ (heater burnout detection current) during the Ton interval. The HB alarm will be OFF in this case. If the heater current is less than $Hb1$ or $Hb2$ (heater burnout detection current) during the Ton interval, the HB alarm will turn ON. Heater burnout is not detected if the ON time (Ton) for the control output for heating is 100 ms or less (30 ms or less if the control period is 0.1 or 0.2 s). Heater burnouts are not detected in the following cases.

- Turn ON the heater power supply simultaneously or before turning ON the E5CC/E5EC power supply. If the heater power supply is turned ON after turning ON the E5CC/E5EC power supply, the HB alarm will be output.
- Control will be continued even when there is an HB alarm.
- The rated current may sometimes differ slightly from the actual current flowing to the heater. Use the Heater Current 1 Value Monitor and Heater Current 2 Value Monitor parameters to check the current during actual operation
- If there is little difference between the current in normal and abnormal states, detection may be unstable. To stabilize detection, set a current difference of at least 1.0 A for heaters lower than 10.0 A, and at least 2.5 A for heaters of 10.0 A or higher. If the heater current is too low, loop the load line several times through a CT, as shown in the following diagram. Looping it through once will double the detected current.

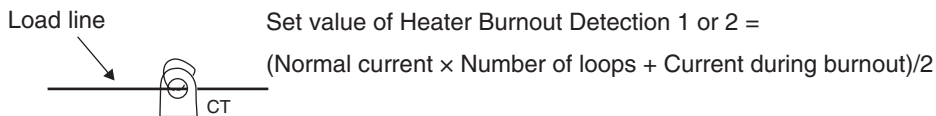



● Operating Procedure

Set the HB ON/OFF parameter in the Advanced Function Setting Level, and set the Heater Burnout Detection 1 parameter in the Adjustment Level.

Heater Burnout Detection 1 = 2.5

Operating Procedure

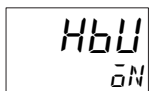

- Checking the HB ON/OFF Parameter Setting

<p>1 Press the Key several times in the Advanced Function Setting Level to display HbU (HB ON/OFF).</p>	<p>Advanced Function Setting Level</p>  <p>HbU HB ON/OFF $\bar{O}N$</p>
<p>2 Check to see if the set value is $\bar{O}N$ (enabled). The default is $\bar{O}N$ (enabled).</p>	 <p>HbU $\bar{O}N$</p>

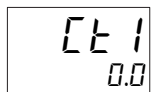
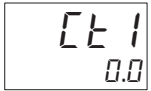
- Checking the Heater Current

1 Press the  Key several times in the Adjustment Level to display Cl 1 (Heater Current 1 Value Monitor).	Adjustment Level  Heater Current 1 Value Monitor
2 Check the heater current from the CT input that is used to detect heater burnout. The monitoring range is 0.0 to 55.0 A.	

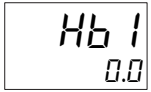
- Setting Heater Burnout Detection

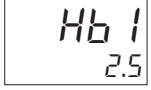
1 Press the  Key several times in the Adjustment Level to display Hb 1 (Heater Burnout Detection 1).	Adjustment Level  Heater Burnout Detection 1
2 Press the  or  Key to set the set value to 2.5 Refer to 4-12-4 Calculating Detection Current Values when you set the value.	

4-12-2 HS Alarm

● What Is an HS Alarm?

A heater short alarm operates by detecting the heater current with a current transformer (CT) for time-proportional PID control or ON/OFF control. If the detected current is greater than the specified heater short detection current even though the control output is OFF, a heater short will be assumed and an alarm will be output.

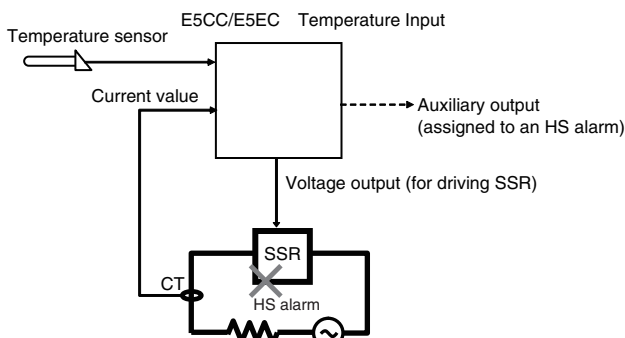

An HS alarm is separate from alarms 1 to 4.

The HS Alarm Use parameter and other parameters must be set in the Advanced Function Setting Level. With the default settings, the HS alarm is output on auxiliary output 1. You can use the output assignment parameters to change the output. You can use an integrated alarm to output an OR of alarms 1 to 4 and the other alarms. For details on the integrated alarm, refer to 5-9 OR Output of Alarms.

● Parameters

Parameter	No. 1 display	Value	No. 2 display	Level
HS Alarm Use	<i>HSU</i>	OFF or ON (default: ON)	<i>OFF, ON</i>	Advanced Function Setting Level
HS Alarm Latch	<i>HSL</i>	OFF or ON (default: OFF)	<i>OFF, ON</i>	
HS Alarm Hysteresis	<i>HSH</i>	0.1 to 50.0 A (default: 0.1 A)	0.1 to 50.0	

Parameter	No. 1 display	Value	No. 2 display	Level
HS Alarm 1 or 2 (alarm current)	<i>HS1</i> <i>HS2</i>	0.0 to 50.0 A (default: 50.0 A)	0.0 to 50.0	Adjustment Level
Leakage Current 1 or 2 Monitor	<i>LER1</i> <i>LER2</i>	0.0 to 55.0 A	0.0 to 55.0	
Auxiliary Output 1 to 4 Assignment	<i>Sub 1</i> to <i>Sub 4</i>	HS: HS alarm or HA: Heater alarm	<i>HS</i> or <i>HA</i>	Advanced Function Setting Level

- A heater short is detected by measuring the leakage current while the control output for heating is OFF. (Heater burnout detection and heater short detection cannot be used with the control output for cooling.)

Control output (heating)	Power to heater	HS alarm output
OFF	Yes (HS alarm)	ON
	No (normal)	OFF

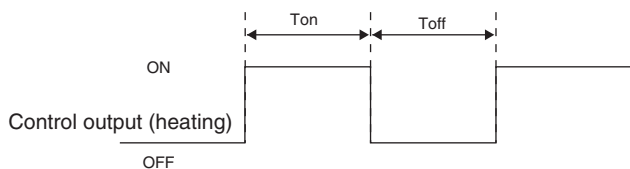

In the above diagram, power is considered to be OFF (normal) if the leakage current is less than *HS1* or *HS2* (heater short detection current) during the *Toff* interval. The HS alarm will be OFF in this case. If the leakage current is greater than *HS1* or *HS2* (heater short detection current) during the *Toff* interval, the HS alarm will turn ON. Heater shorts are not detected if the OFF time (*Toff*) for the control output for heating is 100 ms or less (35 ms or less if the control period is 0.1 or 0.2 s). Heater shorts are not detected in the following cases.

- Control will be continued even when there is an HS alarm.
- The rated current may sometimes differ slightly from the actual current flowing to the heater. Use the Leakage Current 1 Value Monitor and Leakage Current 2 Value Monitor parameters to check the leakage current during actual operation



Set the HS Alarm Use parameter to ON in the Advanced Function Setting Level and set the HS Alarm 1 parameter in the Adjustment Level. This procedure sets the HS Alarm 1 parameter to 2.5.

Operating Procedure

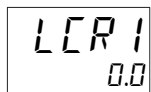

- Setting the HS Alarm Use Parameter

<p>1 Press the  Key several times in the Advanced Function Setting Level to display <i>HSU</i> (HS Alarm Use).</p>	<p>Advanced Function Setting Level</p> <div style="border: 1px solid black; padding: 5px; display: inline-block;"> <p><i>HSU</i> <i>ON</i></p> </div> <p>HS Alarm Use</p>
<p>2 Set the set value to <i>ON</i> (enabled). The default is <i>ON</i> (enabled).</p>	<div style="border: 1px solid black; padding: 5px; display: inline-block;"> <p><i>HSU</i> <i>ON</i></p> </div>

- Setting the Leakage Current Value Monitor

<p>1 Press the  Key several times in the Adjustment Level to display LCR 1 (Leakage Current 1 Value Monitor).</p>	<p>Adjustment Level</p>  <p>Leakage Current 1 Value Monitor</p>
<p>2 Check the leakage current from the CT input that is used to detect heater short. The monitoring range is 0.0 to 55.0 A.</p>	

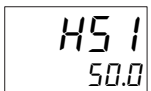
- Setting Heater Short Alarm Detection

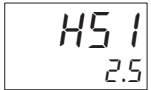
<p>1 Press the  Key several times in the Adjustment Level to display HS 1 (HS Alarm 1).</p>	<p>Adjustment Level</p>  <p>HS Alarm 1</p>
<p>2 Press the  or  Key to set the set value to 2.5 Refer to 4-12-4 Calculating Detection Current Values when you set the value.</p>	

- If there is little difference between the current in normal and abnormal states, detection may be unstable. To stabilize detection, set a current difference of at least 1.0 A for heaters lower than 10.0 A, and at least 2.5 A for heaters of 10.0 A or higher. If the heater current is too low, loop the load line several times through a CT, as shown in the following diagram. Looping it through once will double the detected current.

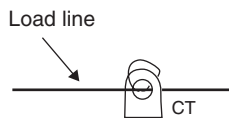

Set value of HS Alarm 1/2 parameter = (Leakage current value when output is OFF + HS current value × Number of loops)/2

4-12-3 Installing Current Transformers (CT)

- CTs can be used for the heater burnout (HB) and heater short (HS) alarms. For the E5CC, connect the CT in advance to terminals 16 and 17 (CT1), or 17 and 18 (CT2). For the E5EC, connect the CT in advance to terminals 19 and 20 (CT1) or 20 and 21 (CT2). Then pass the heater power line through the hole in the CT. For specifications, models, and dimensions of the CTs that can be used with the Digital Controller, refer to A-2 Current Transformer (CT).

(1) Single-phase Heaters

For single-phase heaters, install the CT in the position shown in the following diagram.

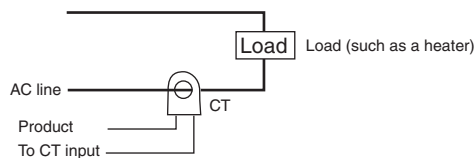

(2) Three-phase Heaters

When a 3-phase power supply is used, regardless of the types of connecting lines, two current transformers (CTs) are required to detect heater burnouts and heater shorts.

(a) Delta connecting lines: Refer to the following diagram for CT installation positions.

* Heater voltage fluctuations are not considered, so be sure to take that into account when setting the detection current.

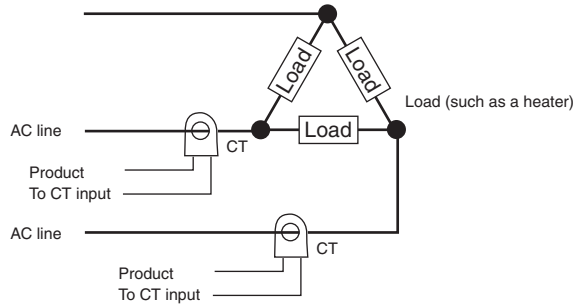

(b) Star connecting lines: Refer to the following diagram for CT installation positions.

* Heater voltage fluctuations are not considered, so be sure to take that into account when setting the detection current.

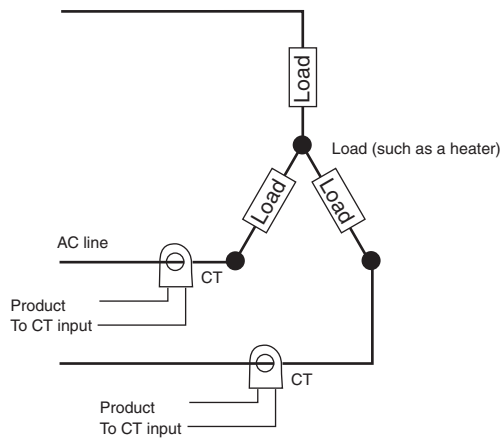

(c) V connecting lines: Refer to the following diagram for CT installation positions.

* Heater voltage fluctuations are not considered, so be sure to take that into account when setting the detection current.

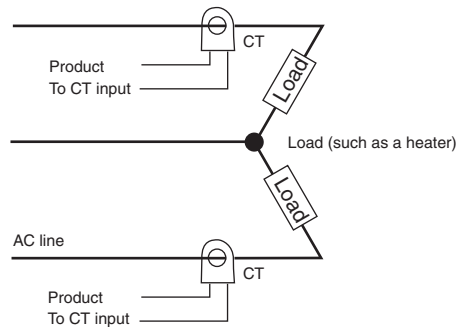

4-12-4 Calculating Detection Current Values

Calculate the set value using the following equation:

$$\text{Heater Burnout Detection 1/2 set value} = \frac{\text{Normal current value} + \text{Burnout current value}}{2}$$

$$\text{HS Alarm 1/2 set value} = \frac{\text{Leakage current value (output OFF)} + \text{HS current value}}{2}$$

- To set the current for heater burnout when two or more heaters are connected through the CT, use the value from when the heater with the smallest current burns out. If all of the heaters have the same current, use the value from when any one of them burns out.
Example: Set value of Heater Burnout Detection 1 or 2 parameter = (Normal current value × Number of loops + Burnout current value)/2
- Make sure that the following conditions are satisfied:
Heater with a current of less than 10.0 A:
(Normal current value) – (Burnout current value) ≥ 1 A
When the difference is less than 1 A, detection is unstable.
Heater with a current of 10.0 A or more:
(Normal current value) – (Burnout current value) ≥ 2.5 A
When the difference is less than 2.5 A, detection is unstable.
- The setting range is 0.1 to 49.9 A. Heater burnouts and heater shorts are not detected when the set value is 0.0 or 50.0. When the set value is 0.0, the HB alarm is always OFF and the HS alarm is always ON. When the set value is 50.0, the HB alarm is always ON and the HS alarm is always OFF.
- Set the total current value for normal heater operation to 50 A or less. When a current value of 55.0 A is exceeded, FFFF is displayed in the Heater Current 1 (or 2) Value Monitor and Leakage Current 1 (or 2) Monitor parameters.

4-12-5 Application Examples

(1) Single-phase Heaters

Example: Using a 200-VAC, 1-kW Heater

Normal

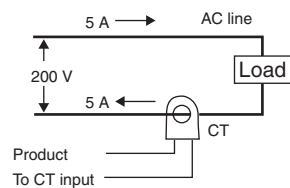

Burnout

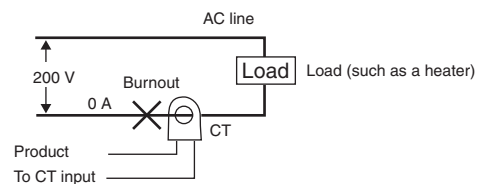

The heater power supply provides 5 A when the current is normal, and 0 A when there is a burnout, so the heater burnout detection current is calculated as follows:

$$\begin{aligned} \text{Heater burnout detection current} &= \frac{(\text{Normal current}) + (\text{Heater burnout current})}{2} \\ &= \frac{5 + 0}{2} = 2.5 \text{ [A]} \end{aligned}$$

Example: Using Three 200-VAC, 1-kW Heaters

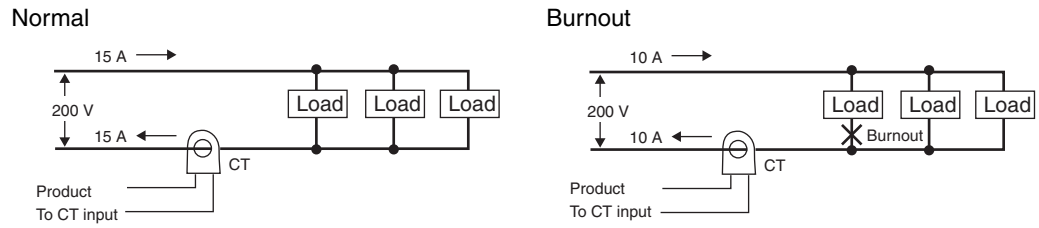

The heater power supply provides 15 A when the current is normal, and 10 A when there is a burnout, so the heater burnout detection current is calculated as follows:

$$\text{Heater burnout detection current} = \frac{(\text{Normal current}) + (\text{Heater burnout current})}{2}$$

$$= \frac{15 + 10}{2} = 12.5 \text{ [A]}$$

(2) Three-phase Heaters

(a) Delta Connecting Lines

Example: Using Three 200-VAC, 2-kW Heaters

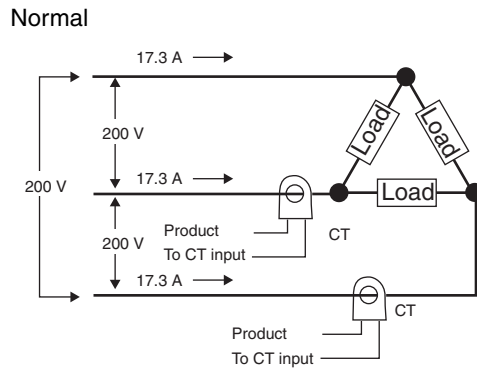

The current when each phase is normal is 17.3 A ($\approx \sqrt{3} \times 10$ A).

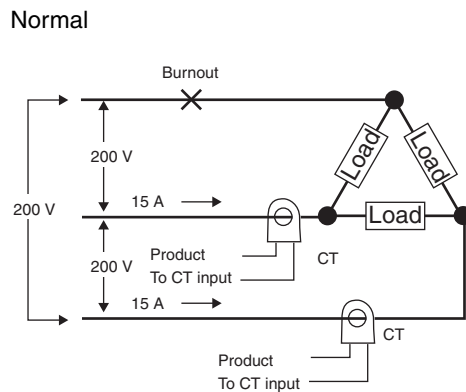

Current when there is a burnout = $10 \text{ A} \times \sqrt{3} \times (\sqrt{3}/2) = 15 \text{ A}$

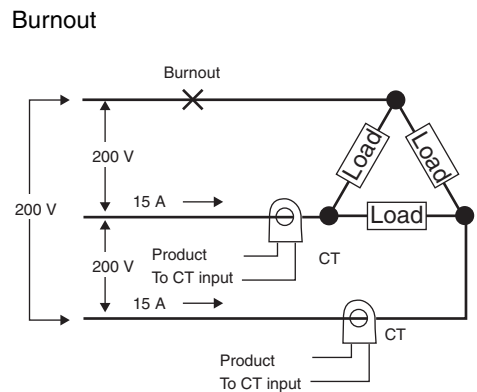

Current when there is a burnout = $10 \text{ A} \times \sqrt{3} \times (1/\sqrt{3}) = 10 \text{ A}$

The heater burnout current when there is a burnout at the load line is as follows:
 (Heater burnout detection current) = $(17.3 + 15) / 2 = 16.15 \text{ [A]}$

The heater burnout current when there is a burnout at the load is as follows:

$$(\text{Heater burnout detection current}) = (17.3 + 10) / 2 = 13.65 \text{ [A]}$$

To enable detection in either case, use 16.1 A as the heater burnout detection current.

(b) Star Connecting Lines

Example: Using Three 200-VAC, 2-kW Heaters

Normal

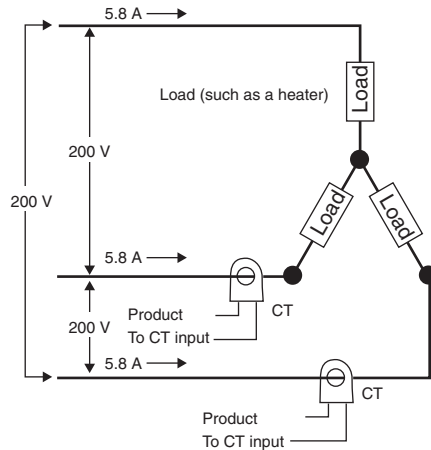

The current when each phase is normal is 5.8 A ($\approx 10 \text{ A} \times (1/\sqrt{3})$).

Normal

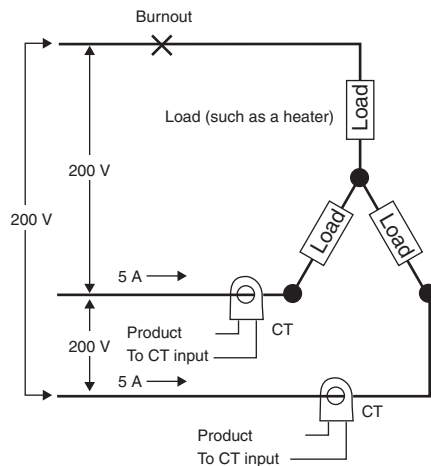

Current when there is a burnout = $10 \text{ A} \times (1/\sqrt{3}) \times (\sqrt{3}/2) = 5 \text{ A}$

Burnout

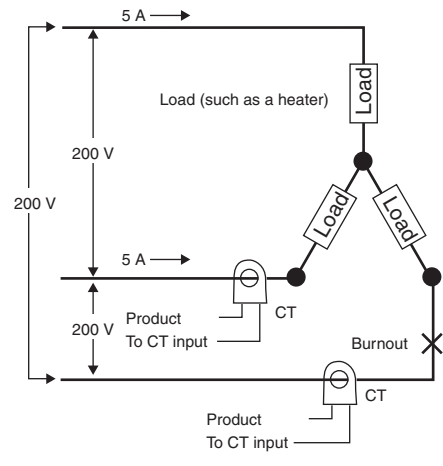

Current when there is a burnout = $10 \text{ A} \times (1/\sqrt{3}) \times (\sqrt{3}/2) = 5 \text{ A}$

The heater burnout detection current for this connecting line is 5.4 A (= (5.8 + 5) / 2).

(c) V Connecting Lines

Example: Using Two 200-VAC, 2-kW Heaters

Normal

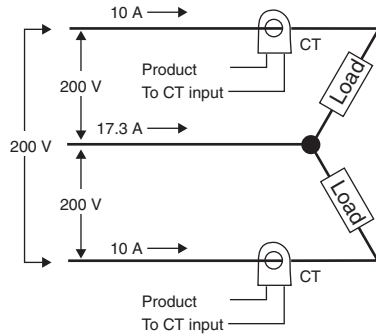

Normal

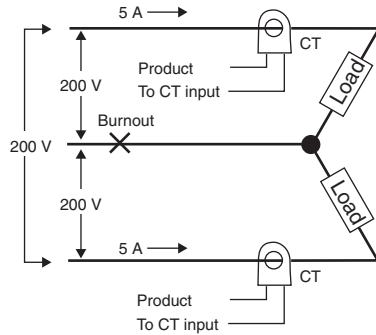

Current when there is a burnout =
 $10 \text{ A} \times (1/2) = 5 \text{ A}$

Burnout

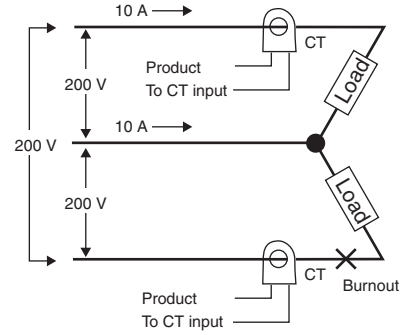

Current when there is a burnout = 0 A

The heater burnout current when there is a burnout at the common is as follows:

$$\text{Heater burnout detection current} = (10 + 5) / 2 = 7.5 \text{ [A]}$$

The heater burnout current when there is a burnout at the load is as follows:

$$\text{Heater burnout detection current} = (10 + 0) / 2 = 5 \text{ [A]}$$

To enable detection in either case, use 7.5 A as the heater burnout detection current.

4-13 Customizing the PV/SP Display

The following table shows the contents of the No. 1, 2, and 3 displays, according to the setting of the PV/SP Display Screen Selection parameter. (Only the E5EC has a No. 3 display.)

4-13-1 PV/SP Display Selections

The following table shows the contents of the No. 1, 2, and 3 displays, according to the setting of the PV/SP Display Screen Selection parameter in the Advanced Function Setting Level. (Only the E5EC has a No. 3 display.)

Set value	No. 1 display	No. 2 display	No. 3 display (E5EC only)
0	Nothing is displayed.	Nothing is displayed.	Nothing is displayed.
1	PV	SP	Nothing is displayed.
2	PV	Nothing is displayed.	Nothing is displayed.
3	SP	SP (character display)	Nothing is displayed.
4	PV	SP	MV
5	PV	SP	Multi-SP No.
6	PV	SP	Soak Time Remain
7	PV	SP	Internal Set Point (ramp SP)
8	PV	SP	Alarm Value 1*

* The set value of the Alarm Value 1 parameter is displayed even if it is not valid due to the setting of the Alarm 1 Type parameter.

	Monitoring range	Unit
PV	Temperature input: The specified range for the specified sensor. Analog input: Scaling lower limit $-5\%FS$ to Scaling upper limit $+5\%FS$	EU

	Setting (monitoring) range	Unit
SP	SP lower limit to SP upper limit	EU

During temperature input, the decimal point position depends on the currently selected sensor, and during analog input it depends on the Decimal Point parameter setting.

PV/SP Display Selections

Code	Parameter	Default	Level
$SPd1$	PV/SP No. 1 Display Selection	4	Advanced Function Setting Level
$SPd2$	PV/SP No. 2 Display Selection	0	

● MV Displays for Heating and Cooling Control

Select either the manipulated variable for heating or the manipulated variable for cooling as the MV to be displayed for PV/SP/MV during heating and cooling control. The MV Display Selection parameter is displayed only when heating/cooling control is being performed and PV/SP/MV is selected in the PV/SP Display Screen parameter or a Monitor/Setting Item Display parameter.

Code	Parameter	Set value	Displayed value	Level
$mdSL$	MV Display Selection	$\bar{0}$	MV (heating)	Advanced Function Setting Level
		$\bar{L} - \bar{0}$	MV (cooling)	

5

Advanced Operations

5-1	Shifting Input Values	5-3
5-2	Setting Scaling Upper and Lower Limits for Analog Inputs	5-5
5-3	Executing Heating/Cooling Control	5-7
5-3-1	Heating/Cooling Control	5-7
5-4	Using Event Inputs	5-11
5-4-1	Event Input Settings	5-11
5-4-2	How to Use the Multi-SP Function	5-11
5-4-3	Operation Commands Other than Multi-SP	5-12
5-5	Setting the SP Upper and Lower Limit Values	5-15
5-5-1	Set Point Limiter	5-15
5-5-2	Setting	5-16
5-6	Using the SP Ramp Function to Limit the SP Change Rate	5-17
5-6-1	SP Ramp	5-17
5-7	Using the Key Protect Level	5-19
5-7-1	Protection	5-19
5-7-2	Entering the Password to Move to the Protect Level	5-20
5-8	Displaying Only Parameters That Have Been Changed	5-22
5-8-1	Displaying Changed Parameters	5-22
5-9	OR Output of Alarms	5-24
5-9-1	Integrated Alarm	5-24
5-10	Alarm Delays	5-26
5-10-1	Alarm Delays	5-26
5-11	Loop Burnout Alarm	5-28
5-11-1	Loop Burnout Alarm (LBA)	5-28
5-12	Performing Manual Control	5-31
5-12-1	Manual Operation	5-31
5-13	Using the Transfer Output	5-34
5-13-1	Transfer Output Function	5-34
5-14	Using the Simple Program Function	5-37
5-14-1	Simple Program Function	5-37
5-14-2	Operation at the Program End	5-39
5-14-3	Application Example Using a Simple Program	5-41

5-15 Output Adjustment Functions	5-42
5-15-1 Output Limits	5-42
5-15-2 MV at Stop	5-42
5-15-3 MV at PV Error	5-43
5-16 Using the Extraction of Square Root Parameter	5-44
5-16-1 Extraction of Square Roots	5-44
5-17 Setting the Width of MV Variation	5-46
5-17-1 MV Change Rate Limit	5-46
5-18 Setting the PF Key	5-48
5-18-1 PF Setting (Function Key)	5-48
5-19 Displaying PV/SV Status	5-51
5-19-1 PV and SV Status Display Functions	5-51
5-20 Communications with a Host Device (e.g., a PLC)	5-53
5-21 Using a Remote SP	5-55
5-22 Logic Operations	5-57
5-22-1 The Logic Operation Function (CX-Thermo)	5-57
5-22-2 Using Logic Operations	5-57

5-1 Shifting Input Values

● Shifting Inputs

You can set the Process Value Slope Coefficient and Process Value Input Shift parameters to compensate the PV.

Parameter	Setting range	Unit	Default
Process Value Input Shift	Temperature input: -199.9 to 999.9	°C or °F	0.0
	Analog input: -1,999 to 9,999	EU	0
Process Value Slope Coefficient	0.001 to 9.999	None	1.000

- Calculating the Process Value Slope Coefficient and Process Value Input Shift
In the following equation, PV_i is the input to the calculation, PV_o is the result, $INRT$ is the process value slope coefficient, and INS is the process value input shift: $PV_o = (PV_i \times INRT) + INS$

● Moving Average

- The moving average operation reduces sudden changes in the input due to noise and other factors, and can be enabled separately for each input.
- The Moving Average Count parameter is used for the moving average. It can be set to OFF, 2, 4, 8, 16, or 32.
- The default is OFF (disabled).

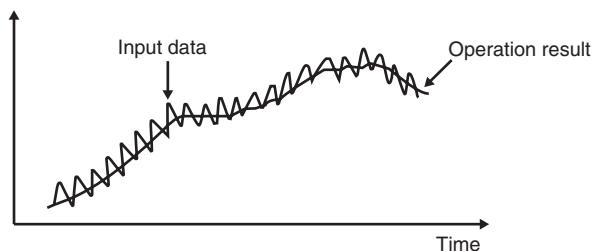

Parameter	Setting range	Unit	Default
Moving Average Count	OFF, 2, 4, 8, 16, or 32	Times	OFF

● Using the PV Input Shift

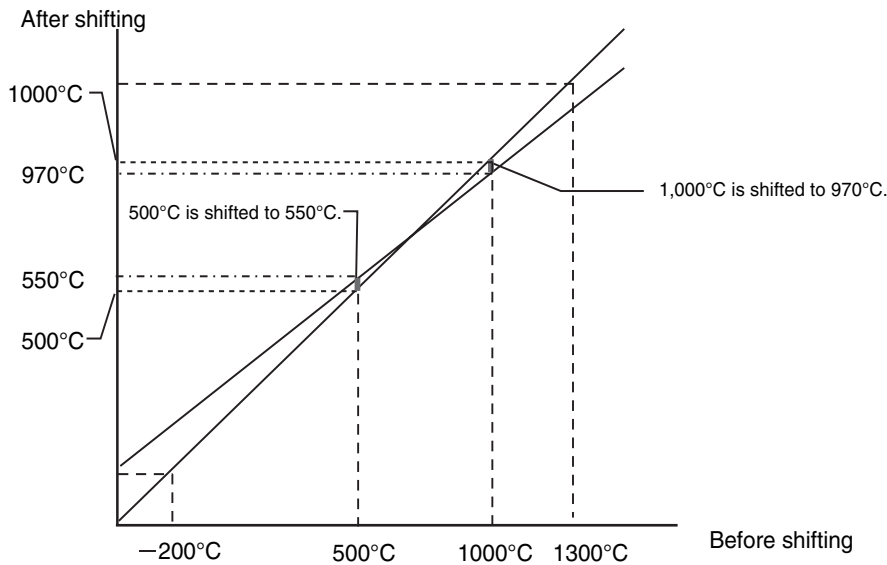

- (1) **Find the two points to shift and determine the PVs after the shifts are applied.**
 Example: Shift 500°C (temperature before shifting) to 550°C (temperature after shifting).
 Example: Shift 1,000°C (temperature before shifting) to 970°C (temperature after shifting).
- (2) **Find the process value slope coefficient from the above results.**

$$(970 - 550) / (1,000 - 500) = 0.840$$
 * Do not yet set the Process Value Slope Coefficient parameter in the Digital Controller.
- (3) **Adjust the PV display on the Digital Controller to the point to be shifted.**
 Example: Adjust the PV to 500°C.
- (4) **Set the Process Value Slope Coefficient parameter to the value that you found in step 2.**
 Example: Set the Process Value Slope Coefficient parameter to 0.840.
- (5) **Read off the PV after the setting is changed.**
 Example: The PV will be displayed as 420°C.
- (6) **Find the difference between the anticipated PV (i.e., the PV after shifting) and the PV that you read off in step 5.**
 Example: $550^{\circ}\text{C} - 420^{\circ}\text{C} = 130^{\circ}\text{C}$
- (7) **Set the Process Value Input Shift parameter to the value that you found in step 6.**
 Example: Set the Process Value Input Shift parameter to 130°C.

5-2 Setting Scaling Upper and Lower Limits for Analog Inputs

● Analog Input

$\bar{L}N-H$ Scaling Upper Limit

$\bar{L}N-L$ Scaling Lower Limit

dP Decimal Point

- When an analog input is selected, scaling can be performed as needed by the control application.
- Scaling is set in the Scaling Upper Limit, Scaling Lower Limit, and Decimal Point parameters (Initial Setting Level). These parameters cannot be used when a temperature input is selected.
- The Scaling Upper Limit parameter sets the physical quantity to be expressed by the upper limit value of input, and the Scaling Lower Limit parameter sets the physical quantity to be expressed by the lower-limit value of input. The Decimal Point parameter specifies the number of digits below the decimal point.
- The following figure shows a scaling example for a 4 to 20 mA input. After scaling, the temperature can be directly read. Here, one place below the decimal point is set.

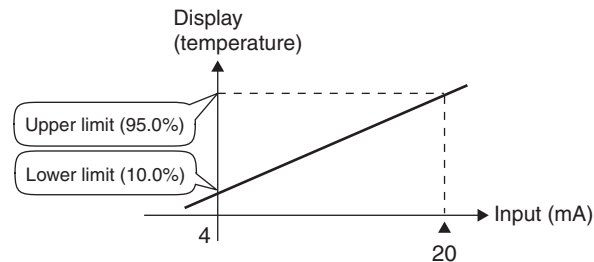

In this example scaling is set to display 4 to 20 mA as 10.0% to 95.0%.

Operating Procedure



- Setting the Input Type

<p>1 Move to the Initial Setting Level. $\bar{L}N-L$ (Input Type) will be displayed.</p>	<p>Initial Setting Level</p> <p>$\bar{L}N-L$ Input Type 5</p>
<p>2 Press the \uparrow or \downarrow Key to set the value to 25. The default is 5.</p>	<p>$\bar{L}N-L$ 25</p>



- Setting the Scaling Upper Limit

<p>1 Press the Ⓢ Key several times in the Initial Setting Level to display $\bar{L}N-H$ (Scaling Upper Limit).</p>	<p>Initial Setting Level</p> <p>$\bar{L}N-H$ Scaling Upper Limit 100</p>
<p>2 Press the \uparrow or \downarrow Key to set the value to 950. The default is 100.</p>	<p>$\bar{L}N-H$ 950</p>

- Setting the Scaling Lower Limit

<p>1 Press the  Key several times in the Initial Setting Level to display $\bar{L}N-L$ (Scaling Lower Limit).</p>	<p>Initial Setting Level</p> <div style="border: 1px solid black; padding: 5px; display: inline-block;"> $\bar{L}N-L$ 0 </div> <p>Scaling Lower Limit</p>
<p>2 Press the  or  Key to set the value to 100. The default is 0.</p>	<div style="border: 1px solid black; padding: 5px; display: inline-block;"> $\bar{L}N-L$ 100 </div>

- Setting the Decimal Point

<p>1 Press the  Key several times in the Initial Setting Level to display dP (Decimal Point).</p>	<p>Initial Setting Level</p> <div style="border: 1px solid black; padding: 5px; display: inline-block;"> dP 0 </div> <p>Decimal Point</p>
<p>2 Press the  or  Key to set the value to 1. The default is 0.</p>	<div style="border: 1px solid black; padding: 5px; display: inline-block;"> dP 1 </div>

5-3 Executing Heating/Cooling Control

5-3-1 Heating/Cooling Control

Heating/cooling control can be used with control output 2 and auxiliary outputs 1 to 4. Heating/cooling control operates when $H-L$ (heating/cooling) is selected for the Standard or Heating/Cooling parameter. The following functions are assigned to outputs in the default status.

Parameter name	Display	Initial status
Control Output 1 Assignment	$\overline{OUT} 1$	Control output for heating
Control Output 2 Assignment	$\overline{OUT} 2$	Not assigned.
Auxiliary Output 1 Assignment	$SUB 1$	Alarm 1*
Auxiliary Output 2 Assignment	$SUB 2$	Alarm 2
Auxiliary Output 3 Assignment	$SUB 3$	Alarm 3
Auxiliary Output 4 Assignment (E5EC only)	$SUB 4$	Alarm 4

* If the Controller is equipped with HB/HS alarm detection, it is set by default to HA (Heater Alarm).

Each output assignment is automatically initialized as shown below when changing between standard and heating/cooling control.

Assigned Output Functions

Controllers with Three or Fewer Auxiliary Outputs

Parameter name	Display	Without control output 2		With control output 2	
		Standard	Heating/cooling	Standard	Heating/cooling
Control Output 1 Assignment	$\overline{OUT} 1$	Control output (heating)	Control output (heating)	Control output (heating)	Control output (heating)
Control Output 2 Assignment	$\overline{OUT} 2$	---	---	Not assigned.	Control output (cooling)
Auxiliary Output 1 Assignment	$SUB 1$	Alarm 1*	Alarm 1*	Alarm 1*	Alarm 1*
Auxiliary Output 2 Assignment	$SUB 2$	Alarm 2	Control output (cooling)	Alarm 2	Alarm 2
Auxiliary Output 3 Assignment	$SUB 3$	Alarm 3	Alarm 3	Alarm 3	Alarm 3

Controllers with Four Auxiliary Outputs

Parameter name	Display	Without control output 2		With control output 2	
		Standard	Heating/cooling	Standard	Heating/cooling
Control Output 1 Assignment	$\overline{OUT} 1$	Control output (heating)	Control output (heating)	Control output (heating)	Control output (heating)
Control Output 2 Assignment	$\overline{OUT} 2$	---	---	Not assigned.	Control output (cooling)
Auxiliary Output 1 Assignment	$SUB 1$	Alarm 1*	Alarm 1*	Alarm 1*	Alarm 1*

Parameter name	Display	Without control output 2		With control output 2	
		Standard	Heating/cooling	Standard	Heating/cooling
Auxiliary Output 2 Assignment	Sub2	Alarm 2	Alarm 2	Alarm 2	Alarm 2
Auxiliary Output 3 Assignment	Sub3	Alarm 3	Alarm 3	Alarm 3	Alarm 3
Auxiliary Output 4 Assignment	Sub4	Alarm 4	Control output (cooling)	Alarm 4	Alarm 4

* If the Controller is equipped with HB/HS alarm detection, it is set by default to *HR* (Heater Alarm). If the Program Pattern parameter is changed to a setting other than OFF, Auxiliary Output 1 Assignment parameter is set as the program end output.

- The heating/cooling operation of the control outputs will switch when the Direct/Reverse Operation parameter is set to direct operation.
- When DRS (Invert Direct/Reverse Operation) is set for an Event Input Assignment 1 to 6 parameter, control will start with the opposite of the setting of the Direct/Reverse Operation parameter when the event input turns ON. When the event input turns OFF, control will return to operation according to the setting of the Direct/Reverse Operation parameter. For details on event inputs and control combined with the Direct/Reverse Operation parameter, refer to *Control by Inverting Direct/Reverse Operation* on page 5-13.
- If heating/cooling control is selected, also set the Dead Band, Proportional Band (Cooling), Integral Time (Cooling), Derivative Time (Cooling), and Heating/Cooling Tuning Method parameters.

● Dead Band

- For heating/cooling control, the dead band is set with the set point as its center. The dead band width is the set value of the Dead Band parameter (Adjustment Level). Setting a negative value produces an overlapping band.
- If an overlapping band is set, the bumpless function may not operate when switching between manual operation and automatic operation.
- The default is 0.0 EU for Controllers with Temperature Inputs and 0.00% FS for Controllers with Analog Inputs.

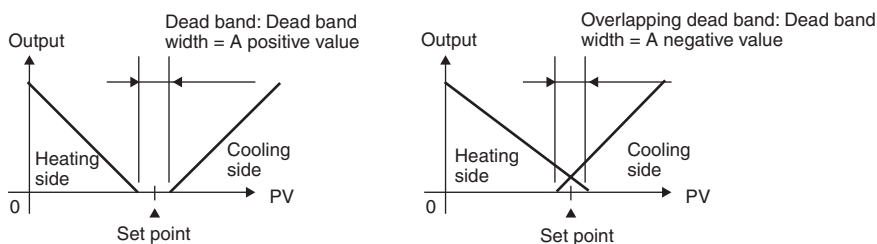

● Heating/Cooling PID Control

If heating/cooling PID control is used, you can set PID control separately for heating and cooling. The PID constants for both heating and cooling can be automatically set according to the cooling control characteristics by setting the Heating/Cooling Tuning Method parameter and then performing autotuning (AT).

Parameter	Setting range	Default	Level
Heating/Cooling Tuning Method	0: Same as heating control	0	Advanced Function Setting Level
	1: Linear		
	2: Air cooling		
	3: Water cooling		

Parameter	Setting range	Unit	Default	Level	
Proportional Band (Cooling)	Temperature input	0.1 to 999.9	°C or °F	8.0	Adjustment Level
	Analog input		%FS	10.0	
Integral Time (Cooling)*	Integral/Derivative Time Unit of 1 s	0 to 9999	Seconds	233	
	Integral/Derivative Time Unit of 0.1 s		Seconds	233.0	
Derivative Time (Cooling)*	Integral/Derivative Time Unit of 1 s	0 to 9999	Seconds	40	
	Integral/Derivative Time Unit of 0.1 s		Seconds	40.0	

* The unit is determined by the setting of the Integral/Derivative Time Unit parameter. The Proportional Band (Cooling), Integral Time (Cooling), and Derivative Time (Cooling) parameters are initialized if the Integral/Derivative Time Unit parameter is changed.

Air Cooling/Water Cooling Tuning

Control that is suitable for an application that does not have linear cooling characteristics (such as plastic molding machines) is performed. The response is fast and the response characteristics are stable.

Linear Tuning

Control that is suitable for an application that has linear cooling characteristics is performed.

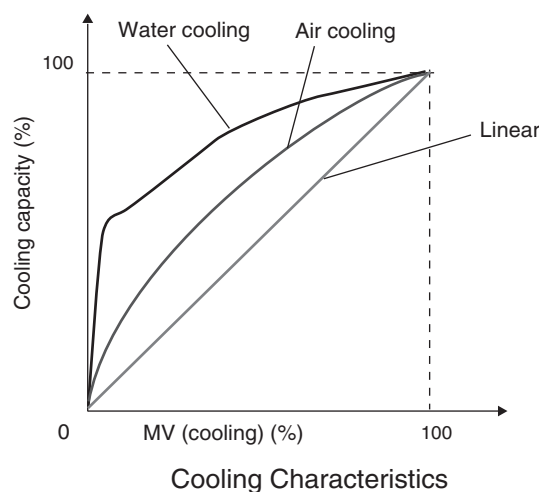

● **Three-position Control**

- Set the PID ON/OFF parameter to $\bar{0}N\bar{0}F$ and set the Standard or Heating/Cooling Parameter to $H-L$ to perform three-position control.
- A dead band (an area where the MV is 0) can be set for either heating or cooling control.

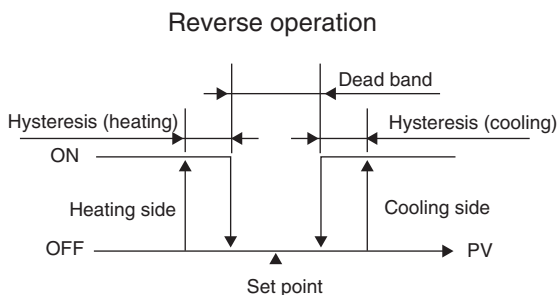

5-4 Using Event Inputs

5-4-1 Event Input Settings

- The number of event inputs that is supported depends on the model of the Digital Controller.
E5CC: Up to 4 event inputs
E5EC: Up to 6 event inputs
- Event inputs can be used for switching between RUN and STOP, switching between automatic and manual operation, starting/resetting the program, inverting direct/reverse operation, switching the SP mode, executing/canceling 100% AT, executing/canceling 40% AT, enabling/disabling setting changes, enabling/disabling communications write, canceling the alarm latch, and switching the multi-SP number.

5-4-2 How to Use the Multi-SP Function

The multi-SP function allows you to set up to eight set points (SP 0 to 7) in the Adjustment Level. The set point can be switched by operating the keys on the front panel or by using external input signals (event inputs).

● Using Event Inputs

The following table shows the relationships between the ON/OFF status of multi-SP number switching bits 0 to 2 and the set point.

Selected set point	Multi-SP No. switching bits		
	Bit 0	Bit 1	Bit 2
SP 0	OFF	OFF	OFF
SP 1	ON	OFF	OFF
SP 2	OFF	ON	OFF
SP 3	ON	ON	OFF
SP 4	OFF	OFF	ON
SP 5	ON	OFF	ON
SP 6	OFF	ON	ON
SP 7	ON	ON	ON

Note: Any bits that are not assigned to event inputs are treated as being OFF.

● Using Key Operations

You can select any of the set points 0 to 7 by changing the set value of the Multi-SP Uses parameter. The Multi-SP Uses parameter display conditions are as follows:

- Controllers without event inputs for which the Number of Multi-SP Points parameter is not set to OFF
- Controllers with event inputs for which the Number of Multi-SP Points parameter is not set to OFF and the Event Input Assignment 1 to 6 parameters are not set to Multi-SP switching bits 0 to 2

The following table shows the relationship between the Multi-SP Uses parameter set value and the selected set point

Multi-SP	Selected set point
0	SP 0
1	SP 1
2	SP 2
3	SP 3

Multi-SP	Selected set point
4	SP 4
5	SP 5
6	SP 6
7	SP 7

Note: The set point can also be switched using communications.

5-4-3 Operation Commands Other than Multi-SP

The following table shows the functions that can be assigned when an Event Input Assignment 1 or 6 parameter is displayed.

Setting	Function
<i>NONE</i>	None
<i>STOP</i>	RUN/STOP
<i>MANU</i>	Auto/Manual
<i>PRST</i>	Program Start*1
<i>DRS</i>	Invert Direct/Reverse Operation
<i>RSP</i>	SP mode switch*2
<i>RE-2</i>	100% AT Execute/Cancel
<i>RE-1</i>	40% AT Execute/Cancel*3
<i>WEPE</i>	Setting Change Enable/Disable
<i>EMWE</i>	Communications Write Enable/Disable*4
<i>LRE</i>	Alarm Latch Cancel
<i>MSP0</i>	Multi-SP No. switching bit 0
<i>MSP1</i>	Multi-SP No. switching bit 1
<i>MSP2</i>	Multi-SP No. switching bit 2

*1 PRST (Program Start) can be set even when the Program Pattern parameter is set to OFF, but the function will be disabled.

*2 This function can be set only for a Controller that supports a remote SP input.

*3 This function can be set for heating/cooling control, but the function will be disabled.

*4 This function can be set only for a Controller that supports communications. Also, when a work bit is selected as the event input data, Communications Write Enable/Disable cannot be assigned.

Turn event inputs ON and OFF while the power is being supplied. Event input ON/OFF changes are detected for inputs of 50 ms or longer.

The functions are described in detail below.

● Executing Run/Stop Control

When the Event Input Assignment parameter is set to STOP (RUN/STOP), control is started when event input turns OFF. Control is stopped when the input turns ON. Alarm outputs, however, will be according to the process value.

The STOP indicator will light while control is stopped.

Setting	Input contact	Status
Event input	ON	STOP
Event input	OFF	RUN

● Switching between Auto and Manual Control

When the Event Input Assignment parameter is set to MANU (auto/manual), manual control will start when event input turns ON. Auto control will start when the input turns OFF.

The MANU indicator will light during manual control.

Setting	Input contact	Status
Event input	OFF	Automatic
Event input	ON	Manual

● Controlling the Start of the Simple Program Function

When the Event Input Assignment parameter is set to PRST (program start), the program will start when the event input turns ON. The program will be reset when the input turns OFF and the RUN/STOP status will automatically switch to STOP mode. If the program END output is ON, the program END output will turn OFF.

Setting	Input contact	Status
Event input	OFF	Reset
Event input	ON	Start

● Control by Inverting Direct/Reverse Operation

When the Event Input Assignment parameter is set to DRS (Invert Direct/Reverse Operation) and the Direct/Reverse Operation parameter is set for reverse operation, control starts with direct operation (cooling control) when the event input turns ON and control starts with reverse operation (heating control) when the event input turns OFF.

Setting	Input contact	Direct/Reverse Operation parameter	Status
Event input	OFF	Direct operation (cooling)	Direct operation (cooling)
		Reverse operation (heating)	Reverse operation (heating)
Event input	ON	Direct operation (cooling)	Reverse operation (heating)
		Reverse operation (heating)	Direct operation (cooling)

● Switching the SP Mode

When the Event Input Assignment parameter is set to RSP (SP mode switch), operation with a remote SP will start when the event input turns ON. Operation with a local SP will start when the event input turns OFF. The RSP operation indicator will light during Remote SP Mode.

Setting	Input contact	Status
Event input	OFF	Local SP
Event input	ON	Remote SP

● Switching 100% AT Execute/Cancel

When the Event Input Assignment parameter is set to AT-2 (100% AT Execute/Cancel), 100% AT will be executed when the event input turns ON and will be cancelled when the input turns OFF.

Setting	Input contact	Status
Event input	OFF	100% AT cancelled
Event input	ON	100% AT executed

● Switching 40% AT Execute/Cancel

When the Event Input Assignment parameter is set to AT-1 (40% AT Execute/Cancel), 40% AT will be executed when the event input turns ON and will be cancelled when the input turns OFF.

Setting	Input contact	Status
Event input	OFF	40% AT cancelled
Event input	ON	40% AT executed

● Switching Setting Change Enable/Disable

When the Event Input Assignment parameter is set to WTPT (Setting Change Enable/Disable), the setting change will be disabled when the event input turns ON and will be enabled when the input turns OFF.

Setting	Input contact	Status
Event input	OFF	Enabled
Event input	ON	Disabled

● Switching Communications Write Enable/Disable

When the Event Input Assignment parameter is set to CMWT (Setting Change Enable/Disable), writing with communications will be enabled when the event input turns ON and writing with communications will be disabled when the event input turns OFF.

Setting	Input contact	Status
Event input	OFF	Disabled
Event input	ON	Enabled

● Switching Alarm Latch Cancel

When the Event Input Assignment parameter is set to LAT (Alarm Latch Cancel), all alarm latches (alarms 1 to 4, heater burnout, HS alarm, latch) will be cancelled when event input turns ON.

Setting	Input contact	Status
Event input	OFF	---
Event input	ON	Cancelled

Parameters

Display	Parameter	Description	Level
<i>EV-1</i>	Event Input Assignment 1	Function of event input	Initial Setting Level
<i>EV-2</i>	Event Input Assignment 2		Initial Setting Level
<i>EV-3</i>	Event Input Assignment 3		Initial Setting Level
<i>EV-4</i>	Event Input Assignment 4		Initial Setting Level
<i>EV-5</i>	Event Input Assignment 5		Initial Setting Level
<i>EV-6</i>	Event Input Assignment 6		Initial Setting Level
<i>MSPU</i>	Number of Multi-SP Points		Advanced Function Setting Level

5-5 Setting the SP Upper and Lower Limit Values

5-5-1 Set Point Limiter

The setting range of the set point is limited by the set point limiter. This function can be used to prevent setting incorrect set points. The upper- and lower-limit values of the set point limiter are set using the Set Point Upper Limit and Set Point Lower Limit parameters in the Initial Setting Level. If the set point is not within the range set for the set point limiter as the result of changes to the Set Point Upper Limit or Set Point Lower Limit parameter, the set point will automatically be changed to a value within the set range. When the set point limiter is reset, the set point is forcibly changed to the upper- or lower-limit value of the set point limiter if the set point is out of the limiter range. Also, when the input type and the temperature unit, scaling upper-limit value, or lower-limit value are changed, the set point limiter is forcibly reset to the input setting range or the scaling upper- or lower-limit value.

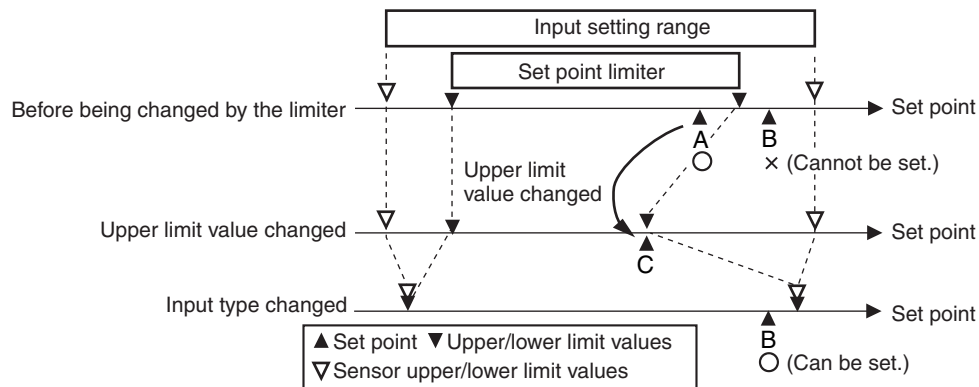

Parameters

Parameters	Parameter	Description	Level
SL-H	Set Point Upper Limit	To limit the SP setting	Initial Setting Level
SL-L	Set Point Lower Limit	To limit the SP setting	Initial Setting Level

5-5-2 Setting

Set the set point upper and lower limits in the Set Point Upper Limit and Set Point Lower Limit parameters in the Initial Setting Level. In this example, it is assumed that the input type is set to a K thermocouple with a temperature range of -200 to 1300°C .

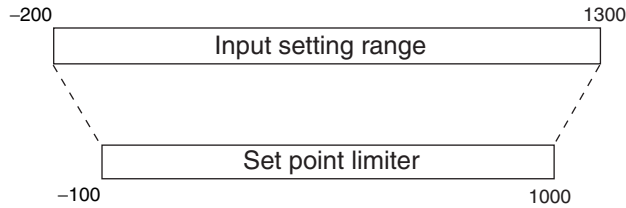



Set the upper and lower limits for the set point.

Set Point Upper Limit = 1000



Set Point Lower Limit = -100

Operating Procedure

- Setting the Set Point Upper Limit

<p>1 Press the  Key several times in the Initial Setting Level to display SL-H (Set Point Upper Limit).</p>	<p>Initial Setting Level</p> <div style="border: 1px solid black; padding: 5px; display: inline-block;"> SL-H 1300 </div> <p>Set Point Upper-limit</p>
<p>2 Press the  or  Key to set the value to 1000. The default is 1300.</p>	<div style="border: 1px solid black; padding: 5px; display: inline-block;"> SL-H 1000 </div>

- Setting the Set Point Lower Limit

<p>1 Press the  Key several times in the Initial Setting Level to display SL-L (Set Point Lower Limit).</p>	<p>Initial Setting Level</p> <div style="border: 1px solid black; padding: 5px; display: inline-block;"> SL-L -200 </div> <p>Set Point Lower Limit</p>
<p>2 Press the  or  Key to set the value to -100. The default is -200.</p>	<div style="border: 1px solid black; padding: 5px; display: inline-block;"> SL-L -100 </div>

5-6 Using the SP Ramp Function to Limit the SP Change Rate

5-6-1 SP Ramp

The SP ramp function is used to restrict the width of changes in the set point as a rate of change. When the SP ramp function is enabled and the change width exceeds the specified rate of change, an area where the set point is restricted will be created, as shown in the following diagram.

During the SP ramp, control will be performed not for the specified set point but rather for the set point restricted by the rate of change set for the SP ramp function.

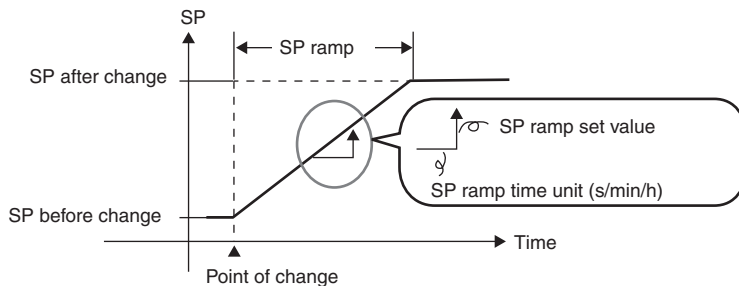

The rate of change during an SP ramp is specified using the SP Ramp Set Value, SP Ramp Fall Value, and SP Ramp Time Unit parameters. The SP Ramp Set Value parameter is set to OFF by default and the SP Ramp Fall Value parameter is set to SAME by default, i.e., the SP ramp function is disabled.

Changes in the ramp set point can be monitored in the Set Point During SP Ramp parameter (Operation Level). Use this parameter when monitoring SP ramp operation.

The SP ramp function operates in the same way when switching the set point using the multi-SP function.

Parameters

Display	Parameter	Description	Level
<i>SPRL</i>	SP Ramp Set Value	To limit the SP rate of change	Adjustment Level
<i>SPRL</i>	SP Ramp Fall Value	To limit the SP rate of change	Adjustment Level
<i>SPRU</i>	SP Ramp Time Unit	Unit for setting the SP	Advanced Function Setting Level
<i>AL SP</i>	Alarm SP Selection	Alarm SP selection	Advanced Function Setting Level

● Operation at Startup

If the SP ramp function is enabled when the Controller is turned ON or when switching from STOP to RUN mode, the process value reaches the set point using the SP ramp function in the same way as when the set point is changed. In this case, operation is carried out with the process value treated as the set point before the change was made. The direction of the SP ramp changes according to the relationship between the process value and the set point.

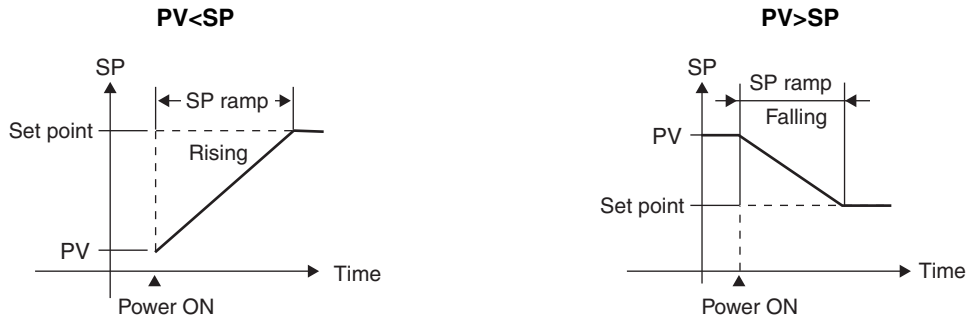

● **Restrictions during SP Ramp Operation**

- Execution of auto-tuning starts after the end of the SP ramp.
- When control is stopped or an error occurs, the SP ramp function is disabled.

● **Alarms during SP Ramp Operation**

The operation of alarms during SP ramp operation depends on whether alarms are set to be based on the ramp set point or the target set point (refer to the following diagrams). The set point to be used is set in the Alarm SP Selection parameter.

Alarm SP Selection = Ramp SP (Alarm Type: 1 (Upper/Lower Limits))

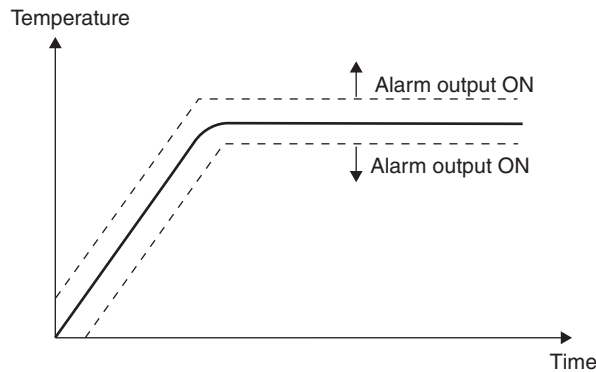

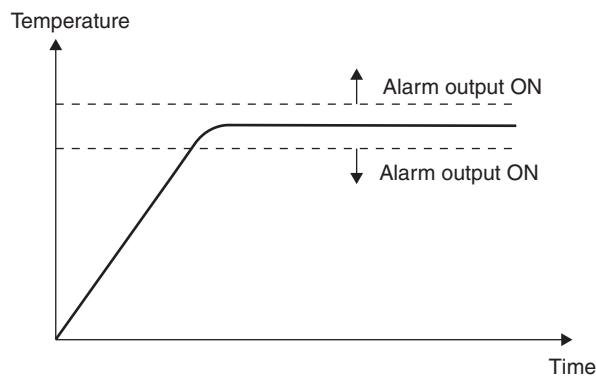

Alarm SP Selection = Target SP (Alarm Type: 1 (Upper/Lower Limits))



5-7 Using the Key Protect Level

5-7-1 Protection

- To move to the Protect Level, press the  and  Keys simultaneously for at least three seconds in Operation Level or Adjustment Level.*
 - * The key pressing time can be changed in the Move to Protect Level Time parameter (Advanced Function Setting Level).
- The Protect Level protects parameters that are not changed during Controller operation until operation is started to prevent them from being modified unintentionally. There are four types of protection: operation/adjustment protect, initial setting/communications protect, setting change protect, and PF Key protect.
- The protect level settings restrict the range of parameters that can be used.

● Operation/Adjustment Protect

The following table shows the relationship between set values and the range of protection.

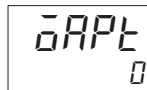

Level		Set value			
		0	1	2	3
Operation Level	PV	Can be displayed	Can be displayed	Can be displayed	Can be displayed
	PV/SP	Can be displayed and changed	Can be displayed and changed	Can be displayed and changed	Can be displayed
	Others	Can be displayed and changed	Can be displayed and changed	Cannot be displayed and moving to other levels is not possible	Cannot be displayed and moving to other levels is not possible
Adjustment Level		Can be displayed and changed	Cannot be displayed and moving to other levels is not possible	Cannot be displayed and moving to other levels is not possible	Cannot be displayed and moving to other levels is not possible

- Parameters are not protected when the set value is set to 0.
- The default is 0.

● Initial Setting/Communications Protect

This protect level restricts movement to the Initial Setting Level, Communications Setting Level, and Advanced Function Setting Level.



Set value	Initial Setting Level	Communications Setting Level	Advanced Function Setting Level
0	Possible to reach	Possible to reach	Possible to reach
1	Possible to reach	Possible to reach	Not possible to reach
2	Not possible to reach	Not possible to reach	Not possible to reach

- The default is 1.

● **Setting Change Protect**

This protect level restricts key operations



Set value	Description
OFF	Settings can be changed using key operations.
ON	Settings cannot be changed using key operations. (The protect level settings, however, can be changed.)

- The default is OFF.
- The setting change protection indicator (On) will light when the Setting Change Protect parameter is set to ON.

● **PF Key Protect**

This protect level enables or disables PF Key operations.

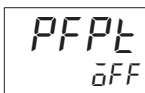

Set value	Description
OFF	PF Key enabled.
ON	PF Key disabled (Operation as function key prohibited).

- The default is OFF.

5-7-2 Entering the Password to Move to the Protect Level

- The Protect Level can be moved to only by displaying the password display and entering the correct password. (The user can set any password in the Password to Move to Protect Level parameter.) If no password is set (i.e., if the password is set to 0 in the Password to Move to Protect Level parameter), the password input display to move to the Protect Level will not be displayed and the Protect Level can be moved to directly.

Move to the Protect Level and set the password.

Example password: 1234

Operating Procedure

● **Password Not Yet Set**

<p>1 Press the and Keys simultaneously for at least 3 seconds (default) in the Operation Level.^{*1} If a password is not set, the Protect Level will be entered and (Operation/Adjustment Protect) will be displayed.</p>	<p>Protect Level</p> <p>Operation/Adjustment Protect</p>
<p>2 Press the Key several times in the Protect Level to display (Password to Move to Protect Level).</p>	<p>Password to Move to Protect Level</p>
<p>3 Press the and Keys simultaneously and set the value to 1234. (This enters the password.) To prevent setting the password incorrectly, the and Keys or and Keys must be pressed simultaneously to set the password.</p>	



*1 The key pressing time can be changed in (Move to Protect Level Time) in the Advanced Function Setting Level. (Setting range: 1 to 30 seconds, Default: 3 seconds)

● Password Already Set

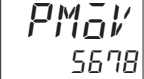
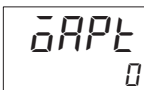
- Deleting the Password (Password Deletion Example: 5678)

<p>1 Press the and Keys simultaneously for at least 3 seconds (default) in the Operation Level.*1 <i>PMāV</i> (Move to Protect Level) will be displayed.</p>	<p>Protect Level</p>  <p>Move to Protect Level</p>
<p>2 Press the or Key to set the password to 5678. (This enters the password.)</p>	
<p>3 Move to the Operation/Adjustment Protect parameter in the Protect Level by pressing the or Key or leaving the setting for at least two seconds. (This deletes the password.)</p>	 <p>Operation/Adjustment Protect</p>

- Setting the Password Again (Password Example: 1234)

<p>1 Set the password to 1234 again. Press the Key several times in the Protect Level to display <i>PRLP</i> (Password to Move to Protect Level).</p>	 <p>Password to Move to Protect Level</p>
<p>2 Press the and Keys simultaneously and set the value to 1234. (This enters the password.) To prevent setting the password incorrectly, the and Keys or and Keys must be pressed simultaneously to set the password.</p>	

*1 The key pressing time can be changed in *PRLT* (Move to Protect Level Time) in the Advanced Function Setting Level. (Setting range: 1 to 30 seconds, Default: 3 seconds)



Precautions for Correct Use

Protection cannot be cleared or changed without the password. Be careful not to forget it. If you forget the password, contact your OMRON sales representative.

● Communications Operation Command to Move to the Protect Level

- The Write Variable operation command can be used via communications to write the password to the Move to Protect Level parameter. When the correct password is written, the display will change to the Operation/Adjustment Protect parameter and writing the parameters in the Protect Level will be enabled.

Note 1: If the Write Variable operation command is used to write the wrong password to the Move to Protect Level parameter after the correct parameter has been written, the Move to Protect Level parameter will be displayed and any Write Variable operation commands to write parameters in the Protect Level will result in operation errors.

2: If a password is not set or if it is set to 0, the display will change to the Operation/Adjustment Protect parameter and writing the parameters in the Protect Level will be enabled immediately.

5-8 Displaying Only Parameters That Have Been Changed

5-8-1 Displaying Changed Parameters

You can display only the parameters that have been changed from their default settings. Parameters that have not been changed will not be displayed. This allows you to easily see which parameters have been changed so that you can check for parameters that still need to be changed or for errors in the settings. This is particularly effective in the Initial Setting Level and Advanced Function Setting Level, where there are many parameters. This can also be used to protect the settings by not displaying unnecessary parameters after the required parameters have been changed. Change $\llbracket HGP$ (Changed Parameters Only) in the Protect Level to ON.

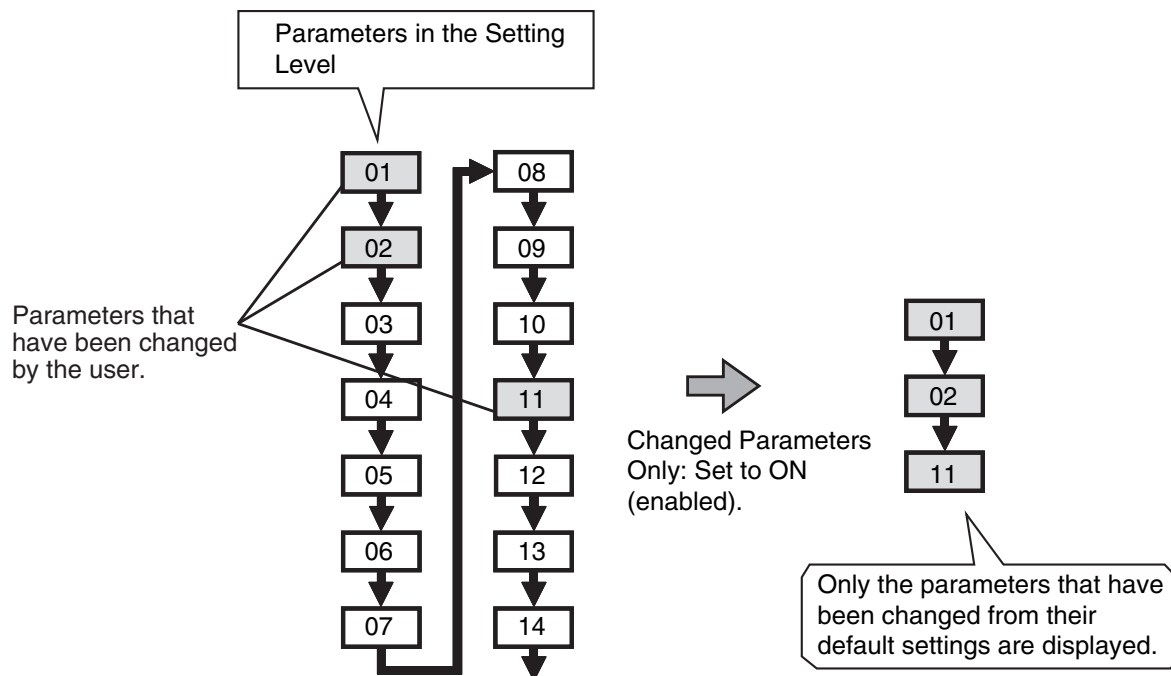

Display	Parameter	Value	Level
$\llbracket HGP$	Changed Parameters Only	OFF (disabled) or ON (enabled) (default: OFF)	Protect Level







Precautions for Correct Use

- Set this parameter to ON only after making the required settings.
- The following parameters are displayed regardless of the setting of the Changed Parameters Only parameter.
 - Monitor parameters (including the PV, parameters with “monitor” in the parameter name and the Set Point During SP Ramp parameter)
 - Parameters that switch operation (RUN/STOP, Auto/Manual Switch, Multi-SP, Program Start, AT Execute/Cancel, Communications Writing, SP Mode, and Parameter Initialization).
 - Level displays and parameters to move to other levels (such as Adjustment Level Display, Move to Advanced Function Setting Level, and Move to Calibration Level)
 - Manual MV
- Any parameters that are automatically initialized when another parameter is changed are considered to be at their default settings.

Example: If the Input Type parameter is changed to 7, 850 is considered to be the default setting of the Set Point Upper Limit parameter. Refer to *A-6-9 Initialization According to Parameter Changes* for the parameters that are automatically initialized.
- If the setting of a parameter is changed back to its default setting, it will no longer be displayed. To display it again, set the Changed Parameters Only parameter to OFF.
- If a parameter is not displayed even when the Changed Parameters Only parameter is set to OFF, check the conditions for the parameter.
- Use parameter masks to select the parameters to display without considering whether they are set to their default settings. The CX-Thermo is required to set parameter masks.

Operating Procedure

<p>1 Press the  Key several times in the Protect Level to display [CHGP] (Changed Parameters Only).</p>	<p>Protect Level</p> <div style="border: 1px solid black; padding: 5px; display: inline-block; text-align: center;"> <p>[CHGP] OFF</p> </div> <p>Changed Parameters Only</p>
<p>2 Press the  or  Key to set the value to ON.</p> <p>Press the  +  Keys for at least 1 s to return to the Operation Level. Only the parameters that have been changed from their default settings will be displayed.</p>	<div style="border: 1px solid black; padding: 5px; display: inline-block; text-align: center;"> <p>[CHGP] ON</p> </div>

5-9 OR Output of Alarms

5-9-1 Integrated Alarm

You can use an integrated alarm to output an OR of alarms 1 to 4, the HB alarm, the HS alarm, the input error, and the RSP input error. Set the Integrated Alarm Assignment parameter (*ALM*) and then assign the integrated alarm (*ALM*) to an auxiliary output or a control output.

● Parameters

Parameter	No. 1 display	Value	No. 2 display	Level
Control Output Assignment	<i>Sub 1</i> to <i>Sub 2</i>	ALM: Integrated alarm (The Integrated Alarm Assignment parameter must be set separately.)	<i>ALM</i>	Advanced Function Setting Level
Auxiliary Output 1 to 4 Assignment	<i>Sub 1</i> to <i>Sub 4</i>	ALM: Integrated alarm (The Integrated Alarm Assignment parameter must be set separately.)	<i>ALM</i>	Advanced Function Setting Level
Integrated Alarm Assignment	<i>ALM</i>	Set the sum of the following values for the alarms and errors to include in the OR output. 0 to 255 Alarm 1: +1 Alarm 2: +2 Alarm 3: +4 Alarm 4: +8 HB alarm: +16 HS alarm: +32 Input error: +64 RSP input error: +128 (Default: 49 (i.e., an OR of alarm 1, the HB alarm, and the HS alarm))	0 to 255	Advanced Function Setting Level

● Operating Procedure

The following procedure outputs an OR of the following alarms on auxiliary output 2.

- Alarm 1
- HB alarm (*Hb*)

The settings are made in the Advanced Function Setting Level.

Operating Procedure



- Assigning the Integrated Alarm to an Auxiliary Output

1 Press the  Key several times in the Advanced Function Setting Level to display *Sub 2* (Auxiliary Output 2 Assignment).

Advanced Function Setting Level





Sub 2
ALM 2

Auxiliary Output 2 Assignment

2 Press the  or  Key to select *ALM* (Integrated Alarm). The default is *ALM 2* (Alarm 2).

Sub 2
ALM

- Setting the Integrated Alarm Assignment Parameter

<p>1 Press the  Key several times in the Advanced Function Setting Level to display <i>ALMA</i> (Integrated Alarm Assignment).</p>	<p>Advanced Function Setting Level</p> <div style="border: 1px solid black; padding: 5px; display: inline-block;">  </div> <p>Integrated Alarm Assignment</p>
<p>2 Press the  or  Key to set the set value to 17 (i.e., the sum of 1 for alarm 1 and 16 for the HB alarm). The default is 49. (Alarm 1 (1) + HB alarm (16) + HS Alarm (32)= 49)</p>	<div style="border: 1px solid black; padding: 5px; display: inline-block;">  </div>



Additional Information

For details on the integrated alarm, refer to *Section 6 Parameters*.

5-10 Alarm Delays

5-10-1 Alarm Delays

- Delays can be set for the alarm outputs. ON and OFF delays can be set separately for alarms 1, 2, 3, and 4. The ON and OFF delays for alarms 1, 2, 3, and 4 also apply to the individual SUB1, SUB2, SUB3, and SUB4 indicators and to communications status. The alarm ON delays will also function when power is turned ON or when moving from the Initial Setting Level to Operation Level (e.g., to software resets). All outputs will turn OFF and the OFF delays will not function when moving to the Initial Setting Level or when an alarm is output for an A/D converter error.

● Operation of Alarm ON and OFF Delays (for an Upper-limit Alarm)

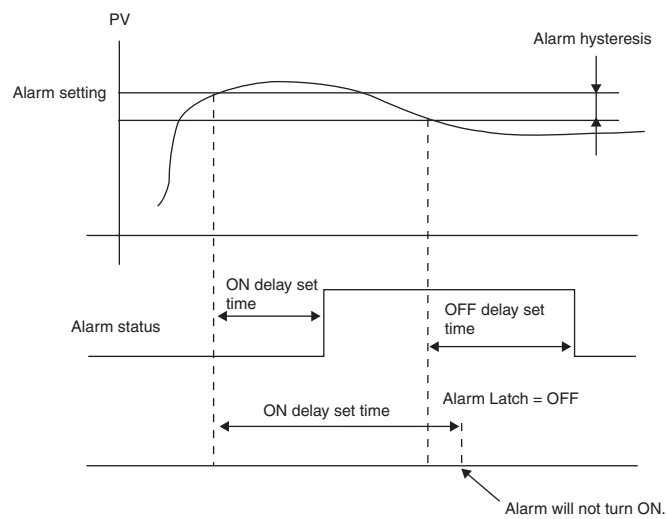

- The alarm will not turn ON if the time that the alarm is ON is equal to or less than the ON delay set time. Also, the alarm will not turn OFF if the time that the alarm is OFF is equal to or less than the OFF delay set time.
- If an alarm turns OFF and then back ON during the ON delay time, the time will be remeasured from the last time the alarm turns ON. Also, if an alarm turns ON and then back OFF during the OFF delay time, the time will be remeasured from the last time the alarm turns OFF.

● Parameters Related to Alarm Delays

Parameter name	Display	Set (monitor) values	Level
Alarm 1 ON Delay	R1 $\bar{O}N$	0 to 999 (s)	Advanced Function Setting Level
Alarm 2 ON Delay	R2 $\bar{O}N$	0 to 999 (s)	
Alarm 3 ON Delay	R3 $\bar{O}N$	0 to 999 (s)	
Alarm 4 ON Delay	R4 $\bar{O}N$	0 to 999 (s)	
Alarm 1 OFF Delay	R1 $\bar{O}F$	0 to 999 (s)	
Alarm 2 OFF Delay	R2 $\bar{O}F$	0 to 999 (s)	
Alarm 3 OFF Delay	R3 $\bar{O}F$	0 to 999 (s)	
Alarm 4 OFF Delay	R4 $\bar{O}F$	0 to 999 (s)	



Note 1: The defaults are 0, i.e., the ON and OFF delays are disabled.

2: The parameters are displayed when alarm functions are assigned and when the alarm type is set to any type but 0 (none), 12: LBA, or 13: PV change rate alarm.

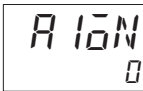

Use the following procedure to set ON and OFF delays for the alarm 1.
An ON delay of 5 seconds and an OFF delay of 10 s will be set.

Operating Procedure

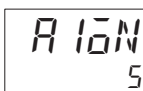
- Setting the Alarm 1 ON Delay

<p>1 Press the  Key several times in the Advanced Function Setting Level to display <i>A 1ON</i> (Alarm 1 ON Delay).</p>	<p>Advanced Function Setting Level</p>  Alarm 1 ON Delay
<p>2 Press the  or  Key to set the value to 5. The default is 0.</p>	

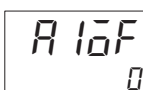
- Setting the Alarm 1 OFF Delay

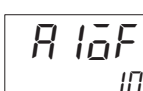
<p>1 Press the  Key several times in the Advanced Function Setting Level to display <i>A 1OF</i> (Alarm 1 OFF Delay).</p>	<p>Advanced Function Setting Level</p>  Alarm 1 OFF Delay
<p>2 Press the  or  Key to set the value to 10. The default is 0.</p>	

5-11 Loop Burnout Alarm

5-11-1 Loop Burnout Alarm (LBA)

- With a loop burnout alarm, there is assumed to be an error in the control loop if the control deviation (SP - PV) is greater than the threshold set in the LBA Level parameter and if the control deviation is not reduced by at least the value set in the LBA Detection Band parameter within the LBA detection time.
- Loop burnout alarms are detected at the following times.

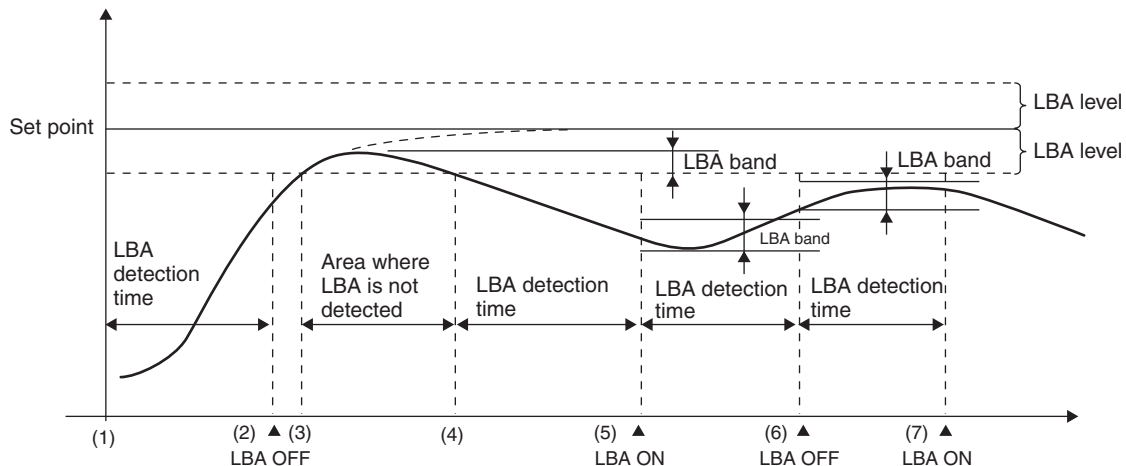

If the control deviation is reduced in the area between 1 and 2 (i.e., the set point is approached) and the amount the control deviation is reduced is at least equal to the LBA band, the loop burnout alarm will remain OFF.

The process value is within the LBA level between 3 and 4, and thus loop burnout alarms will not be detected. (The loop burnout alarm will remain OFF.)

If the process value is outside the LBA level between 4 and 5 and the control deviation is not reduced by at least the LBA band within the LBA detection time, the loop burnout alarm will turn ON. If the control deviation is reduced in the area between 5 and 6 (i.e., the set point is approached) and the amount the control deviation is reduced is at least equal to the LBA band, the loop burnout alarm will turn OFF.

If the control deviation is reduced in the area between 6 and 7 (i.e., the set point is approached) and the amount the control deviation is reduced is less than the LBA band, the loop burnout alarm will turn ON.

- If the LBA detection time, LBA level, LBA detection band, and PID settings are not appropriate, alarms may be detected inappropriately or alarms may not be output when necessary.
- Loop burnout alarms may be detected if unexpectedly large disturbances occur continuously and a large deviation does not decrease.
- If a loop burnout occurs when the set point is near the ambient temperature, the temperature deviation in a steady state may be less than the LBA level, preventing detection of the loop burnout.
- If the set point is so high or low that it cannot be reached even with a saturated manipulated variable, a temperature deviation may remain even in a steady state and a loop burnout may be detected.
- Detection is not possible if a fault occurs that causes an increase in temperature while control is being applied to increase the temperature (e.g., an SSR short-circuit fault).

- Detection is not possible if a fault occurs that causes a decrease in temperature while control is being applied to decrease the temperature (e.g., a heater burnout fault).

● Parameters Related to Loop Burnout Alarms

Parameter name	Display	Setting range		Remarks	Level
LBA Detection Time	<i>LbR</i>	0 to 9999 (s)		Setting 0 disables the LBA function.	Advanced Function Setting Level
LBA Level	<i>LbRL</i>	Temperature input	0.1 to 999.9 (°C/°F)	Default: 8.0 (°C/°F)	
		Analog input	0.01 to 99.99 (%FS)	Default: 10.00% FS	
LBA Band	<i>LbRb</i>	Temperature input	0.0 to 999.9 (°C/°F)	Default: 3.0 (°C/°F)	
		Analog input	0.00 to 99.99 (%FS)	Default: 0.20% FS	

- A loop burnout alarm can be output by setting the alarm 1 type to 12 (LBA).
- A setting of 12 (LBA) can be set for alarms 2 to 4, but the setting will be disabled.
- Loop burnouts are not detected during SP ramp operation.
- Loop burnouts are not detected during auto-tuning, manual operation, or while stopped.
- If the alarm 1 latch is set to ON, the latch will be effective for the loop burnout alarm.

● Automatically Setting the LBA Detection Time

- The LBA detection time is automatically set by auto-tuning.
(It is not set automatically, however, for heating/cooling control.)
- If the optimum LBA detection time is not obtained by auto-tuning, set the LBA Detection Time parameter (Advanced Function Setting Level).

● Determining the LBA Detection Time

- To manually set the LBA detection time, set the LBA Detection Time parameter to twice the LBA reference time given below.

(1) Set the output to the maximum value.

(2) Measure the time required for the width of change in the input to reach the LBA band.

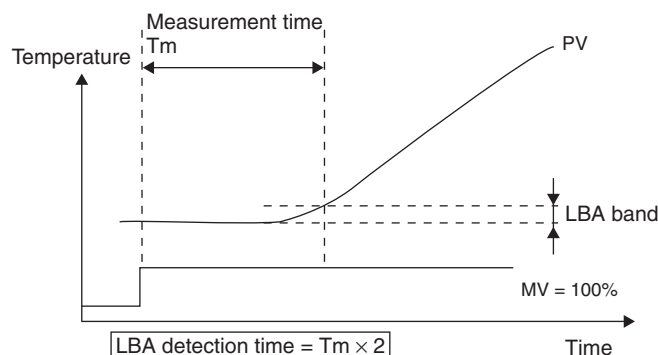

(3) Set the LBA Detection Time parameter to two times the measured time.

● LBA Level

- Set the control deviation when the control loop is working properly.
- The default is 8.0 (°C/°F) for Controllers with Temperature Inputs and 10.00% FS for Controllers with Analog Inputs.

● LBA Band

- There is assumed to be an error in the control loop and the alarm output turns ON if the control deviation is greater than the threshold set in the LBA Level parameter and if the control deviation does not change by at least the value set in the LBA Band parameter.
- The default is 3.0 (°C/°F) for Controllers with Temperature Inputs and 0.20% FS for Controllers with Analog Inputs.

The LBA is used.

The related parameters are as follows:



LBA Detection Time: 10

LBA Level: 8.0

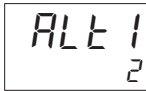

LBA Band: 3.0

Operating Procedure

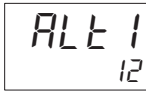

- Setting the LBA

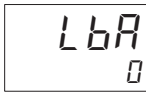
<p>1 Press the  Key several times in the Initial Setting Level to display <i>ALt 1</i> (Alarm 1 Type).</p>	<p>Initial Setting Level</p>  Alarm 1 Type
<p>2 Press the  or  Key to select <i>l2</i> (LBA). The default is <i>2</i> (upper limit).</p>	

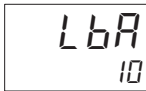

- Setting the LBA Detection Time

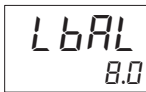
<p>1 Press the  Key several times in the Advanced Function Setting Level to display <i>LbA</i> (LBA Detection Time).</p>	<p>Advanced Function Setting Level</p>  LBA Detection Time
<p>2 Press the  or  Key to set the value to 10. The default is 0 (s).</p>	

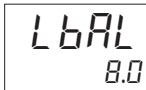
- Setting the LBA Level

<p>1 Press the  Key several times in the Advanced Function Setting Level to display <i>LbAL</i> (LBA Level).</p>	<p>Advanced Function Setting Level</p>  LBA Level
<p>2 Press the  or  Key to set the value to 8.0. The default is 8.0 (°C/°F).</p>	

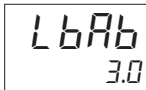
- Setting the LBA Band

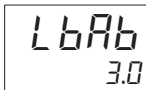
<p>1 Press the  Key several times in the Advanced Function Setting Level to display <i>LbAb</i> (LBA Band).</p>	<p>Advanced Function Setting Level</p>  LBA Band
<p>2 Press the  or  Key to set the value to 3.0. The default is 3.0 (°C/°F).</p>	

5-12 Performing Manual Control

5-12-1 Manual Operation

- The manipulated variable can be set in manual mode if the PV/MV parameter is displayed in the manual control level. If the Manual Output Method parameter is set to HOLD when control moves from Automatic Mode to Manual Mode, the final MV from Automatic Mode will be used as the initial manual MV. If Manual Output Method parameter is set to INIT, the setting of the Manual MV Initial Value parameter will be used as the initial manual MV. In manual mode, changes in the value of the PV/MV (Manual MV) parameter that are made with key operations are saved and reflected in the actual MV immediately.
- The automatic display return function will not operate in manual mode.
- Balanceless-bumpless operation will be performed for the MV when switching from manual operation to automatic operation.*
- If a power interruption occurs during manual operation, manual operation will be restarted when power is restored using the same MV as when power was interrupted.
- Switching between automatic and manual operation is possible for a maximum of one million times.
- Manual operation can be used only for PID control.

* In balanceless-bumpless operation, the MV before switching is used initially after the switch and then gradually changed to achieve the proper value after switch to prevent radical changes in the MV after switching operation.

The manual operation is illustrated in the following figure when Manual Output Method parameter is set to HOLD.

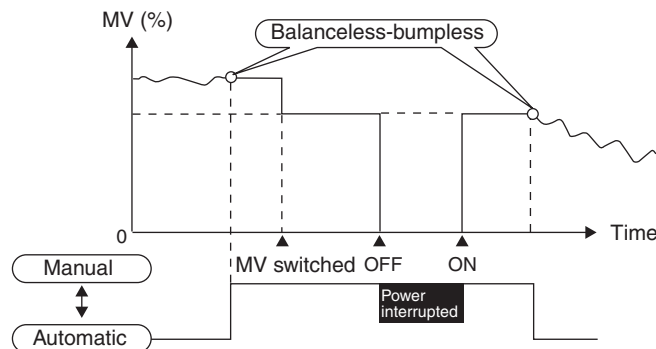

● Related Displays and Parameters

Parameter name	Display	Remarks	Level
PV/MV (Manual MV)	---	Changes the manual MV. -5.0 to 105.0 (heating/cooling control: -105.0 to 105.0)*	Manual Control Level
Auto/Manual Switch	<i>A-M</i>	Switches between automatic and manual modes.	Operation Level
Auto/Manual Select Addition	<i>AMPd</i>	Enables switching between automatic and manual modes.	Advanced Function Setting Level

* For Manual MV Limit Enable, this value will be between the MV upper limit and the MV lower limit.

Note: Refer to 5-15 Output Adjustment Functions for information on the priority for the MV.

Manual Output Method (Advanced Function Setting Level)

Setting range	Unit	Default
HOLD, INIT	None	HOLD

Manual MV Initial Value (Advanced Function Setting Level)



Setting range	Unit	Default
Standard control: -5.0 to 105.0	%	0
Heating/cooling control: -105.0 to 105.0	%	0

● Manual MV Limit Enable (Advanced Function Setting Level)

When the Manual MV Limit Enable parameter is set to ON (enabled), the MV limits will function and the setting range for the Manual MV parameter will be between the MV upper limit and the MV lower limit. When the parameter is set to OFF (disabled), MV limits will not function.

Parameter name	Setting range	Default
Manual MV Limit Enable	OFF: Disabled, ON: Enabled	OFF

● Using the PF Key to Move to the Manual Control Level

- When the PF Setting parameter is set to A-M (Auto/Manual), pressing the PF Key for at least one second while in the Adjustment or Operation Level will change the mode to manual mode and move to the Manual Control Level. During manual operation it is not possible to move to any displays other than PV/MV (Manual MV). Press the  or  Key for at least one second from the PV/MV display in the Manual Control Level to change the mode to automatic mode, move to the Operation Level, and display the top parameter in the Operation Level.

Note 1: Priority of Manual MV and Other Functions

Even when operation is stopped, the manual MV is given priority.

Auto-tuning and self-tuning will stop when manual mode is entered.



2: Manual MV and SP Ramp

If operating, the SP ramp function will continue even when manual mode is entered.

● Moving to the Manual Control Level with an Event Input

- If an event input is set to MANU (auto/manual), you can use the event input to switch between automatic mode and manual mode.

● Auto/Manual Selection Display

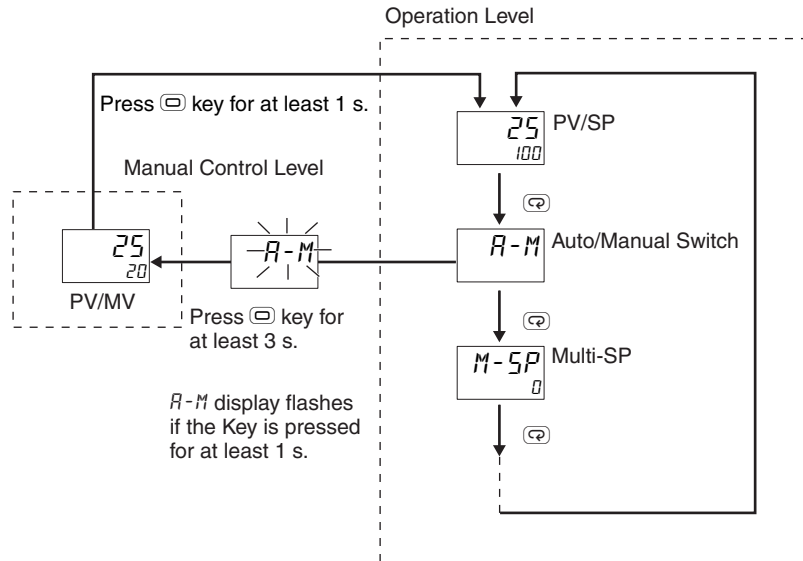

- When the  Key is pressed for at least 3 seconds in the Operation Level's auto/manual switching display, the manual mode will be entered and the Manual Control Level will be displayed. It is not possible to move to any displays except for the PV/MV parameter during manual operation. Press the  Key for at least one second from the PV/MV parameter display in Manual Control Level to return to automatic mode and display the top parameter in the Operation Level.
- To enable using the Auto/Manual Switch parameter (Operation Level), you must, set the Auto/Manual Switch Display Addition parameter (Advanced Function Setting Level) to ON. The default is $\bar{O}FF$.



We will set the PF Setting parameter to A-M (auto/manual).

Operating Procedure

- Setting PID Control

<p>1 Press the Key several times in the Initial Setting Level to display ENEL (PID ON/OFF).</p>	<p>Initial Setting Level</p>  <p>PID ON/OFF</p>
<p>2 Press the or Key to set PID.</p>	

- Setting Auto/Manual Selection

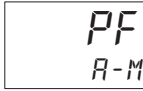
<p>1 Press the Key several times in the Advanced Function Setting Level to display PF (PF Setting).</p>	<p>Advanced Function Setting Level</p>  <p>PF Setting</p>
<p>2 Press the or Key to select A-M (auto/manual).</p>	

- Setting the Manual MV with the Key

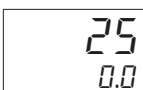
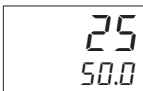
<p>1 Press the Key in the Operation Level to enter the Manual Control Level.</p>	<p>Operation Level</p>  <p>PV/MV</p>
<p>2 Press the or Key to set the manual MV. (In this example, the MV is set to 50%.)*¹</p>	

*1 The manual MV setting must be saved (see page *Applying Changes to Numeric Values* on page 3-7), but values changed with key operations are reflected in the control output immediately.

5-13 Using the Transfer Output

5-13-1 Transfer Output Function

A transfer output can be used on Controllers that have a transfer output.

● Precision and User Calibration

Precision	User calibration
±0.3% FS	Supported.*

* For details on calibration, refer to *Section 6 Parameters*.

Transfer Output Signal (Initial Setting Level)

You can use the Transfer Output Signal parameter to specify whether to output a current or voltage from the transfer output.

Terminal Arrangement

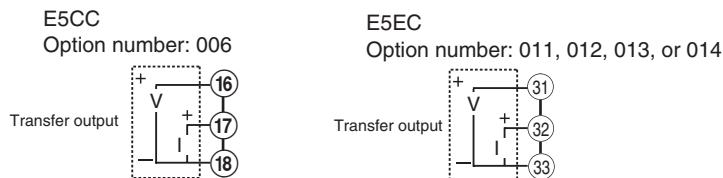

Setting range	Default
4-20: 4 to 20mA	4-20
1-5V: 1-5 V	

● Transfer Output Type (Initial Setting Level)

You can use the Transfer Output Type parameter to specify any of five types of data to output.

Transfer output type	Display	Setting range
OFF*	OFF	---
Set point	SP	SP lower limit to SP upper limit
Set point during SP ramp	SP-M	SP lower limit to SP upper limit
PV	PV	Input setting range lower limit to input setting range upper limit or Scaling lower limit to scaling upper limit
MV monitor (heating)	MV	-5.0 to 105.0 (heating/cooling control: 0.0 to 105.0)
MV monitor (cooling)	E-MV	0.0 to 105.0

* The default is OFF.

● Transfer Scaling

- Reverse scaling is possible by setting the Transfer Output Lower Limit parameter larger than the Transfer Output Upper Limit parameter. If the Transfer Output Lower Limit and Transfer Output Upper Limit parameters are set to the same value, the transfer output will be output continuously at 0%.
- If the SP, SP during SP ramp, or PV is selected, the Transfer Output Upper Limit and Transfer Output Lower Limit parameters will be forcibly initialized to the respective upper and lower setting limits if any of the following parameters is changed: Input Type, Scaling Upper Limit, Scaling Lower Limit, Set Point Upper Limit, Set Point Lower Limit, or Temperature Unit.
If the MV for heating or MV for cooling is selected, the Transfer Output Lower Limit and Transfer Output Upper Limit parameters will be initialized to 100.0 and 0.0, respectively, when a switch is

made between standard control and heating/cooling control using the Standard or Heating/Cooling parameter.

- The output current when transfer output signal is set to 4 to 20 mA, the transfer output upper limit is set to 90.0, and the transfer output lower limit is set to 10.0 is shown in the following graph.
- For scaling from 0.0% to 100.0%, the output for -5.0 to 0.0 will be the same value as for 0.0%, and the output for 100.0 to 105.0 will be the same value as for 100.0%

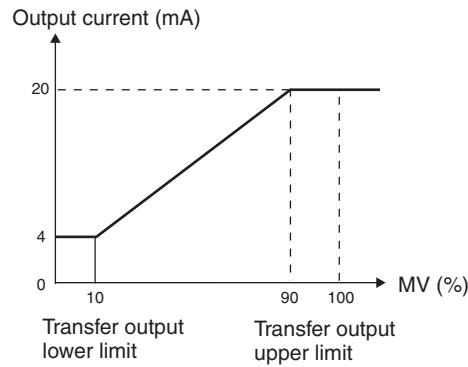



(The above graph is for when transfer output signal is set to 4 to 20 mA.)



The following procedure sets the transfer output for an SP range of –50 to 200.

Operating Procedure



- Setting the Transfer Output Type

<p>1 Press the  Key several times in the Initial Setting Level to display <i>TR-T</i> (Transfer Output Type).</p>	<p>Initial Setting Level</p> <div style="border: 1px solid black; padding: 5px; display: inline-block;"> <i>TR-T</i> <i>OFF</i> </div> <p>Transfer Output Type</p>
<p>2 Press the  or  Key to select <i>SP</i>. The default is <i>OFF</i>.</p>	<div style="border: 1px solid black; padding: 5px; display: inline-block;"> <i>TR-T</i> <i>SP</i> </div>

- Setting the Transfer Output Upper Limit

<p>1 Press the  Key several times in the Initial Setting Level to display <i>TR-H</i> (Transfer Output Upper Limit).</p>	<p>Initial Setting Level</p> <div style="border: 1px solid black; padding: 5px; display: inline-block;"> <i>TR-H</i> <i>1300</i> </div> <p>Transfer Output Upper Limit</p>
<p>2 Press the  or  Key to set the value to 200. The default is 1300.</p>	<div style="border: 1px solid black; padding: 5px; display: inline-block;"> <i>TR-H</i> <i>200</i> </div>

- Setting the Transfer Output Lower Limit

<p>1 Press the  Key several times in the Initial Setting Level to display <i>TR-L</i> (Transfer Output Lower Limit).</p>	<p>Initial Setting Level</p> <div style="border: 1px solid black; padding: 5px; display: inline-block;"> <i>TR-L</i> <i>-200</i> </div> <p>Transfer Output Lower Limit</p>
<p>2 Press the  or  Key to set the value to –50. The default is –200.</p>	<div style="border: 1px solid black; padding: 5px; display: inline-block;"> <i>TR-L</i> <i>-50</i> </div>

5-14 Using the Simple Program Function

5-14-1 Simple Program Function

- The simple program function can be used for the following type of control.

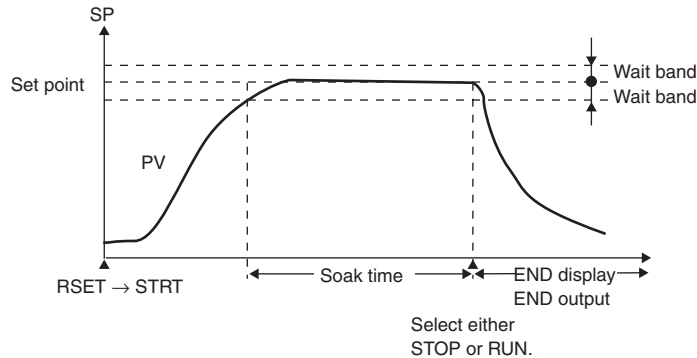

- The program will start when the Program Start parameter is changed from RSET to START. END will be displayed on the No. 2 display and the output assigned as the program end output will turn ON after the time set in the Soak Time parameter has expired in the wait band. The Program Pattern parameter can be used to select moving to STOP mode or continuing operation in RUN mode after the program ends.

Parameters Related to the Simple Program Function

Parameter name	Display	Set (monitor) values	Unit	Display level
Program Pattern	<i>PLRN</i>	OFF, STOP, CONT	---	Initial Setting Level
Program Start	<i>PRSt</i>	RSET, START	---	Operation Level
Soak Time	<i>SoAK</i>	1 to 9999	min or h	Adjustment Level
Soak Time Unit	<i>t-U</i>	m (minutes)/h (hours)	---	Advanced Function Setting Level
Wait Band	<i>Wt-b</i>	OFF or 0.1 to 999.9*	°C or °F*	Adjustment Level
Soak Time Remain Monitor	<i>SKtR</i>	0 to 9999	min or h	Operation Level

* The setting unit of the Wait Band parameter is %FS for Controllers with Analog Inputs and the setting range is OFF or 0.01 to 99.99.

Program Pattern

Either of two program patterns can be selected. The simple program operation will not be performed if the Program Pattern parameter is set to OFF.

(1) Pattern 1 (STOP)

Control will stop and the STOP mode will be entered when the program has ended.

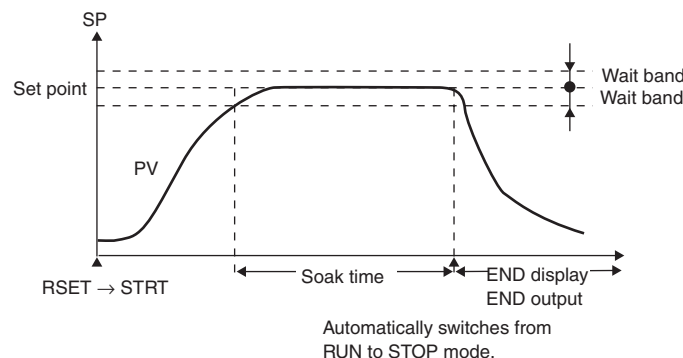

(2) Pattern 2 (CONT)

Control will continue in RUN mode when the program has ended.

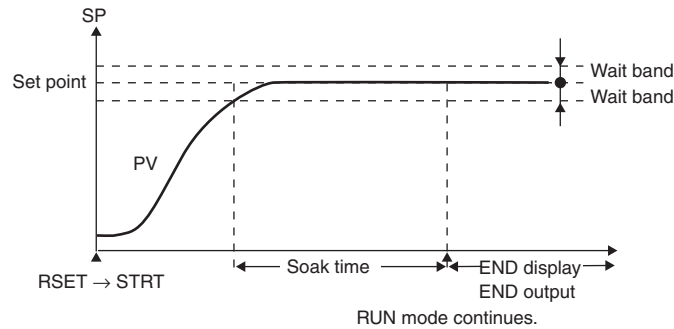

● Starting Method

Any of the following three methods can be used to start the simple program.

- Setting the Program Start parameter to STRT.
- Turning ON an event input. (The program start must be assigned to an event input.*)
- Starting with an Operation Command using communications. (When the program start is not assigned to an event input.)

* When the simple program is started and reset, writing is performed to non-volatile memory. Be sure to consider the write life (1 million writes) of the non-volatile memory in the system design. When the program start is assigned to an event input, the Program Start parameter will function as a monitor display, and the RSET/STRT displays can be used to check when the event input has started or reset the simple program. When this is done, the Program Start parameter functions as a monitor display only and cannot be changed using key operations. If the Program Pattern parameter is set to OFF, the event input assignment setting will be initialized to "None."

● Soak Time and Wait Band

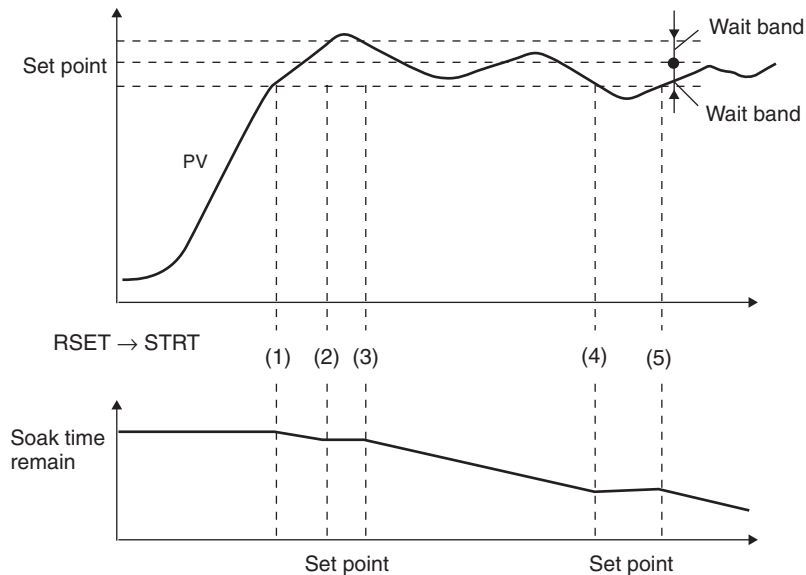

The wait band is the band within which the process value is stable in respect to the set point. The soak time is measured within the wait band. The timer that measures the soak time operates only when the process value is within the wait band around the set point (i.e., $SP \pm \text{wait band}$). In the above diagram, the timer will be stopped between the start and (1), (2) and (3), and (4) and (5) and will measure the time only between (1) and (2), (3) and (4), and (5) and the end.

* If the wait band is set to OFF, the wait band will be treated as infinity and the timer will measure time continuously after changing from RSET to STRT.

5-14-2 Operation at the Program End

- Display at the Program End

When the program ends, the process value will be displayed on the No. 1 display* and the set point and *END* will be alternately displayed on the No. 2 display at 0.5 s intervals.

* One of the following displays: PV/SP, PV only, or PV/MV.

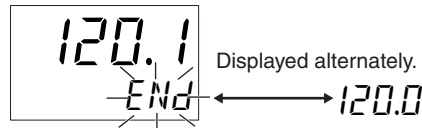

- Program End Output

The output assignment parameters can be used to assign the program END output to any output. The program END output can also be used in communications status.

When the Program Pattern parameter is changed from OFF to STOP or CONT, the Auxiliary Output 1 Assignment parameter will automatically be set to the END output. When the Program Pattern parameter is changed from STOP or CONT to OFF, the Alarm 1 Output Assignment parameter will automatically be initialized to ALM1 (or to HA for Controllers that have HB or HS alarms).

- Clearing the Program End Status

The program END output and display will be cleared when the Program Start parameter is changed from STRT to RSET. The setting is changed from STRT to RSET while the Program Start parameter is displayed.

The program END status can also be cleared using an event. If the program start function is assigned to an event, however, the program end status cannot be cleared from the Program Start parameter display, which will function only as a monitor display.

Simple programming is used.

The related parameters are as follows:

Program pattern: STOP

Soak time = 10 min

Wait band: 3

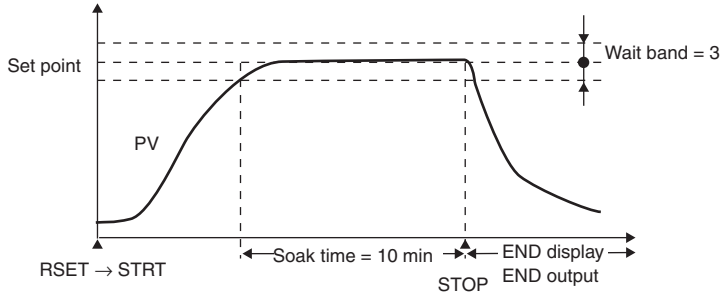

Operating Procedure

- Setting the Program Pattern

<p>1 Press the Key several times in the Initial Setting Level to display <i>PLRN</i> (Program Pattern).</p>	<p>Initial Setting Level</p> <div style="border: 1px solid black; padding: 5px; display: inline-block;"> <i>PLRN</i> <i>OFF</i> </div> <p>Program Pattern</p>
<p>2 Press the or Key to select <i>StoP</i> (STOP). The default is <i>OFF</i>.</p>	<div style="border: 1px solid black; padding: 5px; display: inline-block;"> <i>PLRN</i> <i>StoP</i> </div>

- Setting the Soak Time

<p>1 Press the Key several times in the Adjustment Level to display <i>SoAK</i> (Soak Time).</p>	<p>Adjustment Level</p> <div style="border: 1px solid black; padding: 5px; display: inline-block;"> <i>SoAK</i> 1 </div> <p>Soak Time</p>
<p>2 Press the or Key to set the value to 10. The default is 1 (min or h).</p>	<div style="border: 1px solid black; padding: 5px; display: inline-block;"> <i>SoAK</i> 10 </div>

- Setting the Wait Band

<p>1 Press the Key several times in the Adjustment Level to display <i>Wt-b</i> (Wait Band).</p>	<p>Adjustment Level</p> <div style="border: 1px solid black; padding: 5px; display: inline-block;"> <i>Wt-b</i> <i>OFF</i> </div> <p>Wait Band</p>
<p>2 Press the or Key to set the value to 3.0. The default is <i>OFF</i>.</p>	<div style="border: 1px solid black; padding: 5px; display: inline-block;"> <i>Wt-b</i> 3.0 </div>

5-14-3 Application Example Using a Simple Program

The program will be started by changing the setting of the Program Start parameter. The following example shows using a simple program with the program pattern set to STOP.

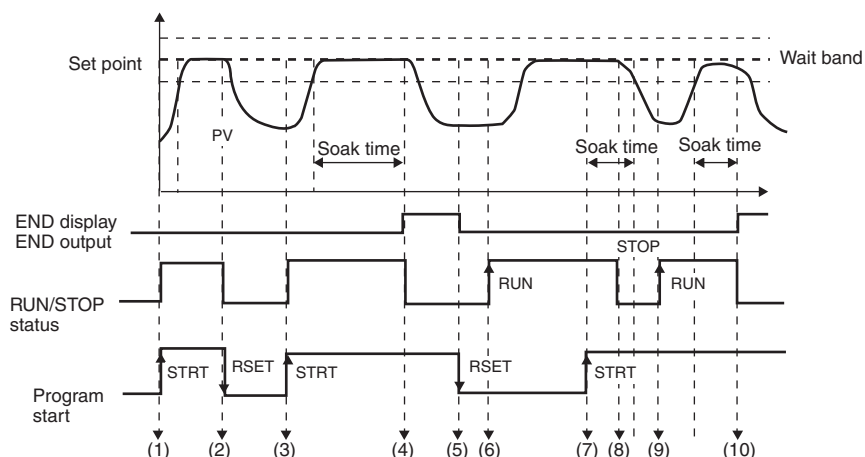

Timing	Description
(1)	<ul style="list-style-type: none"> The Program Start parameter was changed from RSET to STRT using either an event or key operations. The RUN/STOP status automatically changes to RUN mode when the above operation is performed.
(2)	<ul style="list-style-type: none"> The Program Start parameter was changed from STRT to RSET using either an event or key operations before the soak time expired. The RUN/STOP status automatically changes to STOP mode when the above operation is performed.
(3)	<ul style="list-style-type: none"> The Program Start parameter is again changed from RSET to STRT using either an event or key operations. The RUN/STOP status will automatically change to RUN mode when the above operation is performed.
(4)	<ul style="list-style-type: none"> The RUN/STOP status automatically changes to STOP mode when soak time expires. END flashes on the No. 2 display and the program END output turns ON.
(5)	<ul style="list-style-type: none"> The Program Start parameter is changed from STRT to RSET using either an event or key operations. The END display is cleared and the program END output turns OFF.
(6)	<ul style="list-style-type: none"> Key operations are used to switch the RUN/STOP status to RUN with the Program Start parameter set to RSET (stopped). Normal control operation is started.
(7)	<ul style="list-style-type: none"> The Program Start parameter is changed from RSET to STRT using either an event or key operations after the process value stabilizes. The RUN/STOP status remains as RUN.
(8)	<ul style="list-style-type: none"> Key operations are used to change the RUN/STOP status to STOP (during program operation). Measuring the soak time is continued within the wait band. (Measuring the soak time stops when the process value leaves the wait band.)
(9)	<ul style="list-style-type: none"> Key operations are used to change the RUN/STOP status to RUN. Measuring the soak time is continued within the wait band (continuing from the time between (7) and (9)).
(10)	<ul style="list-style-type: none"> The RUN/STOP status automatically changes to STOP mode when the measured time reaches the soak time. END flashes on the No. 2 display and the program END output turns ON.

5-15 Output Adjustment Functions

5-15-1 Output Limits

- Output limits can be set to control the output using the upper and lower limits to the calculated MV.
- The following MV takes priority over the MV limits.
Manual MV*
MV at stop
MV at PV error

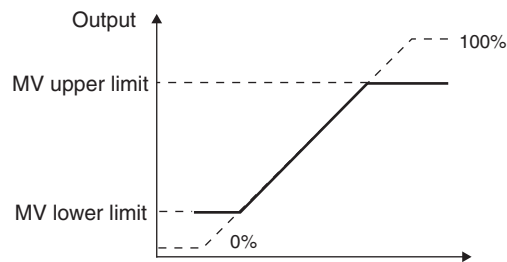

- * When the manual MV limit is enabled, the manual MV will be restricted by the MV limit.
- For heating/cooling control, upper and lower limits are set for overall heating/cooling control. (They cannot be set separately for heating/cooling.)

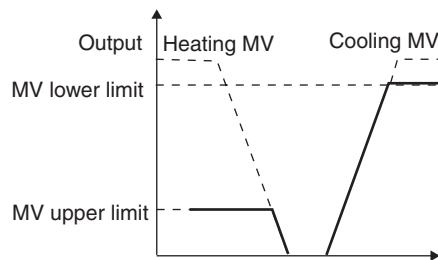

5-15-2 MV at Stop

- The MV when control is stopped can be set.
For heating/cooling control, the MV at stop will apply to the cooling side if the MV is negative and to the heating side if the MV is positive.
When setting the MV when control is stopped, set the MV at Stop and Error Addition parameter (Advanced Function Setting Level) to ON.
The default is 0.0, so an MV will not be output for either standard or heating/cooling control.

Parameter name	Setting range	Unit	Default
MV at STOP	-5.0 to 105.0 for standard control -105.0 to 105.0 for heating/cooling control	%	0.0

Note: The order of priority is as follows: Manual MV > MV at stop > MV at PV error.

5-15-3 MV at PV Error

- The MV to be output for input errors can be set.
The MV at stop takes priority when stopped and the manual MV takes priority in manual mode.

Parameter name	Setting range	Unit	Default
MV at PV ERROR	-5.0 to 105.0 for standard control -105.0 to 105.0 for heating/cooling control	%	0.0

Note: The order of priority is as follows: Manual MV > MV at stop > MV at PV error.

- The order of priority of the MVs is illustrated in the following diagram.

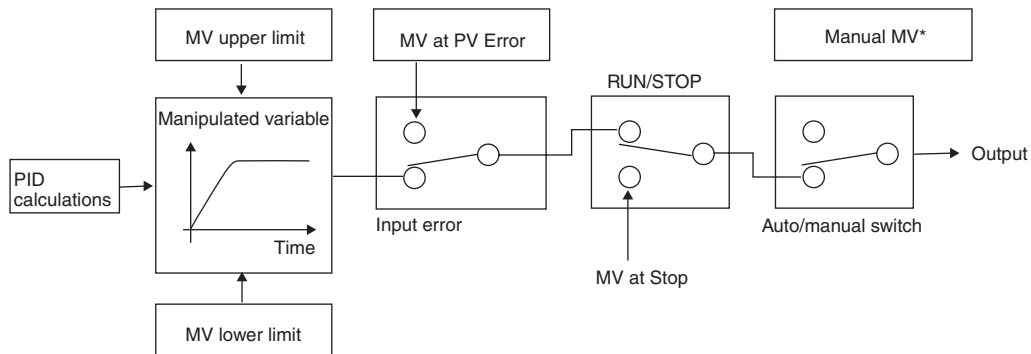

* When the Manual MV Limit Enable parameter is set to ON, the setting range will be the MV lower limit to the MV upper limit.

5-16 Using the Extraction of Square Root Parameter

5-16-1 Extraction of Square Roots

Extraction of Square Root
Enable

SQR
OFF

Extraction of Square Root
Low-cut Point

SRRP
0.0

- For analog inputs, the Extraction of Square Root parameter is provided for inputs so that differential pressure-type flow meter signals can be directly input.
- The default setting for the Extraction of Square Root parameter is OFF. The Extraction of Square Root Enable parameter must be set to ON in order to use this function.
- If the PV input (i.e., the input before extracting the square root) is higher than 0.0% and lower than the low cut point set in the Extraction of Square Root Low-Cut Point parameter, the results of extracting the square root will be 0.0%. If the PV input is lower than 0.0% or higher than 100.0%, extraction of the square root will not be executed, so the result will be equal to the PV input. The low-cut point is set as normalized data for each input, with 0.0 as the lower limit and 100.0 as the upper limit for the input setting range.

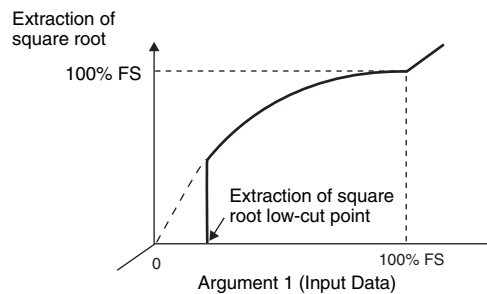

Parameter name	Setting range	Unit	Default	Level
Extraction of Square Root Enable	OFF: Disabled, ON: Enabled	---	OFF	Initial Setting Level
Extraction of Square Root Low-cut Point	0.0 to 100.0	%	0.0	Adjustment Level

This procedure sets the Extraction of Square Root Low-cut Point parameter to 10.0%.



The input type must be set for an analog input.

Operating Procedure

- Enabling Extraction of Square Roots

<p>1 Press the Key several times in the Initial Setting Level to display SQR (Extraction of Square Root Enable).</p>	<p>Initial Setting Level</p> <p> Extraction of Square Root Enable</p>
<p>2 Press the or Key to select ON (Enabled). The default is OFF.</p>	<p></p>

- Setting the Extraction of Square Root Low-cut Point

<p>1 Press the  Key several times in the Adjustment Level to display <i>SQRP</i> (Extraction of Square Root Low-cut Point).</p>	<p>Adjustment Level</p> <div style="border: 1px solid black; padding: 5px; display: inline-block;"> <p><i>SQRP</i> 0.0</p> </div> <p>Extraction of Square Root Low-cut Point</p>
<p>2 Press the  or  Key to set the value to 10.0. The default is 0.0 (%).</p>	<div style="border: 1px solid black; padding: 5px; display: inline-block;"> <p><i>SQRP</i> 10.0</p> </div>

5-17 Setting the Width of MV Variation

5-17-1 MV Change Rate Limit

MV Change Rate
Limit

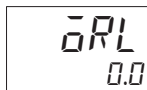

- The MV change rate limit sets the maximum allowable width of change in the MV per second. If the change in the MV exceeds this setting, the MV will be changed by the MV change rate limit until the calculated value is reached. This function is disabled when the setting is 0.0.
- The MV change rate limit does not function in the following situations:
 - In manual mode
 - During ST execution (Cannot be set when ST is ON.)
 - During AT execution
 - During ON/OFF control
 - While stopped (during MV at Stop output)
 - During MV at PV Error output

Parameter name	Setting range	Unit	Default	Level
MV Change Rate Limit	0.0 to 100.0	%/s	0.0	Adjustment Level



This procedure sets the MV change rate limit to 5.0%/s. The related parameters are as follows:

PID ON/OFF = PID



ST = OFF

Operating Procedure



- Setting 2-PID Control

<p>1 Press the  Key several times in the Initial Setting Level to display \overline{ENEL} (PID ON/OFF).</p>	<p>Initial Setting Level</p> <div style="border: 1px solid black; padding: 5px; display: inline-block;"> \overline{ENEL} \overline{ONOFF} </div> <p>PID ON/OFF</p>
<p>2 Press the  or  Key to select \overline{Pid} (PID). The default is \overline{ONOFF} (ON/OFF control).</p>	<div style="border: 1px solid black; padding: 5px; display: inline-block;"> \overline{ENEL} \overline{Pid} </div>

- Turning OFF Self-tuning

<p>1 Press the  Key several times in the Initial Setting Level to display \overline{St} (ST: self-tuning).</p>	<p>Initial Setting Level</p> <div style="border: 1px solid black; padding: 5px; display: inline-block;"> \overline{St} \overline{ON} </div> <p>ST</p>
<p>2 Press the  or  Key to set the value to \overline{OFF}. The default is \overline{ON}.</p>	<div style="border: 1px solid black; padding: 5px; display: inline-block;"> \overline{St} \overline{OFF} </div>

- Setting the MV Change Rate Limit

<p>1 Press the  Key several times in the Adjustment Level to display \overline{aRL} (MV Change Rate Limit).</p>	<p>Adjustment Level</p> <div style="border: 1px solid black; padding: 5px; display: inline-block;"> \overline{aRL} 0.0 </div> <p>MV Change Rate Limit</p>
<p>2 Press the  or  Key to set the value to 5.0. The default is 0.0 (%/s).</p>	<div style="border: 1px solid black; padding: 5px; display: inline-block;"> \overline{aRL} 5.0 </div>

5-18 Setting the PF Key

5-18-1 PF Setting (Function Key)

PF Setting (Advanced Function Setting Level)



- Pressing the PF Key for at least one second executes the operation set in the PF Setting parameter. The default is *SHFT* (digit shift).

Set value	Display	Setting	Function
OFF	<i>OFF</i>	Disabled	Does not operate as a function key.
RUN	<i>RUN</i>	RUN	Specifies RUN status.
STOP	<i>StOP</i>	STOP	Specifies STOP status.
R-S	<i>R-S</i>	RUN/STOP reverse operation	Specifies reversing the RUN/STOP operation status.
AT-2	<i>At-2</i>	100% AT Execute/Cancel	Specifies reversing the 100% AT Execute/Cancel status.*1
AT-1	<i>At-1</i>	40% AT Execute/Cancel	Specifies reversing the 40% AT Execute/Cancel status.*1
LAT	<i>LAt</i>	Alarm Latch Cancel	Specifies canceling all alarm latches.*2
A-M	<i>A-M</i>	Auto/Manual	Specifies reversing the Auto/Manual status.*3
PFDP	<i>PFdP</i>	Monitor/Setting Item	Specifies the monitor/setting item display. Select the monitor/setting item according to the Monitor/Setting Item 1 to 5 parameters (Advanced Function Setting Level).
SHFT	<i>SHFT</i>	Digit Shift	Operates as a Digit Shift Key when settings are being changed.

*1 When AT cancel is specified, it means that AT is cancelled regardless of whether the AT currently being executed is 100% AT or 40% AT.

*2 Alarms 1 to 4, the HB alarm, and the HS alarm are cancelled.

*3 For details on auto/manual operations using the PF Key, refer to 5-12 *Performing Manual Control*.

Note1: Pressing the PF Key for at least one second executes operation according to the set value. (However, if Digit Shift is set, operation will be in less than one second.) When the Monitor/Setting Item parameter is selected, however, the display is changed in order from Monitor/Setting Item 1 to 5 each time the key is pressed.

2: This function is enabled when PF Key Protect is OFF.

● Monitor/Setting Item

Monitor/Setting Item 1
(Advanced Function Setting Level)

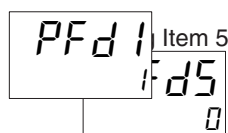

Setting the PF Setting parameter to the Monitor/Setting Item makes it possible to display monitor/setting items using the PF Key. The following table shows the details of the settings. For setting (monitor) ranges, refer to the applicable parameter.

Set value	Setting	Remarks	
		Monitor/Setting	Display
0	Disabled		---
1	PV/SP/Multi-SP	Can be set. (SP) ^{*1}	---
2	PV/SP/MV	Can be set. (SP) ^{*1}	---
3	PV/SP /Soak time remain	Can be set. (SP) ^{*1}	---
4	Proportional band (P)	Can be set.	<i>P</i>

Set value	Setting	Remarks	
		Monitor/Setting	Display
5	Integral time (I)	Can be set.	\bar{I}
6	Derivative time (D)	Can be set.	d
7	Alarm value 1	Can be set.	$AL - 1$
8	Alarm value upper limit 1	Can be set.	$AL 1H$
9	Alarm value lower limit 1	Can be set.	$AL 1L$
10	Alarm value 2	Can be set.	$AL - 2$
11	Alarm value upper limit 2	Can be set.	$AL 2H$
12	Alarm value lower limit 2	Can be set.	$AL 2L$
13	Alarm value 3	Can be set.	$AL - 3$
14	Alarm value upper limit 3	Can be set.	$AL 3H$
15	Alarm value lower limit 3	Can be set.	$AL 3L$
16	Alarm value 4	Can be set.	$AL - 4$
17	Alarm value upper limit 4	Can be set.	$AL 4H$
18	Alarm value lower limit 4	Can be set.	$AL 4L$
19	PV/SP/Internal SP	Can be set. (SP) ^{*1}	---
20	PV/SP/Alarm Value 1 ^{*2}	Can be set. (SP) ^{*1}	---
21	Proportional Band (Cooling)	Can be set.	$\bar{I} - P$
22	Integral Time (Cooling)	Can be set.	$\bar{I} - \bar{I}$
23	Derivative Time (Cooling)	Can be set.	$\bar{I} - d$

*1 With the E5CC, only the PV and SP can be displayed.

*2 The Alarm Value 1 parameter is displayed even if the Alarm 1 Type parameter is set for no alarm. However, any value that is set is not valid.

Setting Monitor/Setting Items

Pressing the $\llbracket PF \rrbracket$ Key in either the Operation or Adjustment Level displays the applicable monitor/setting items. Press the $\llbracket PF \rrbracket$ Key to display in order Monitor/Setting Items 1 to 5. After Monitor/Setting Item 5 has been displayed, the display will switch to the top parameter in the Operation Level.

Note 1: Items set as disabled in the Monitor/Setting Items 1 to 5 parameters will not be displayed, and the display will skip to the next enabled setting.

2: While a monitor/setting item is being displayed, the display will be switched to the top parameter in the Operation Level if the $\llbracket \ominus \rrbracket$ Key or the $\llbracket \omin� \rrbracket$ Key is pressed.





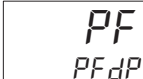

This procedure sets the PF Setting parameter to PFDP, and the Monitor/Setting Item 1 parameter to 7 (Alarm Value 1).

Operating Procedure

- Setting the PF Key

<p>1 Press the $\llbracket \omin� \rrbracket$ Key several times in the Advanced Function Setting Level to display <i>PF</i> (PF Setting).</p>	<p>Advanced Function Setting Level</p>  <p>PF Setting</p>
<p>2 Press the $\llbracket \uparrow \rrbracket$ or $\llbracket \downarrow \rrbracket$ Key to select <i>PFdP</i> (Monitor/Setting Item). The default is <i>SHFL</i> (digit shift).</p>	

- Setting the Monitor/Setting Items

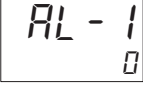
<p>1 Press the  Key several times in the Advanced Function Setting Level to display <i>PFd 1</i> (Monitor/Setting Item 1).</p>	<p>Advanced Function Setting Level</p> <div style="border: 1px solid black; padding: 5px; display: inline-block;">  </div> <p>Monitor/Setting Item 1</p>
<p>2 Press the  or  Key to select 7 (Alarm Value 1). The default is 1 (PV/SP/Multi-SP No.).</p>	<div style="border: 1px solid black; padding: 5px; display: inline-block;">  </div>
<p>3 Return to the Operation Level and press the  Key to display <i>AL - 1</i> (Alarm Value 1).</p>	<p>Monitor/Setting Item Level</p> <div style="border: 1px solid black; padding: 5px; display: inline-block;">  </div> <p>Monitor/Setting Item Display 1</p>

5-19 Displaying PV/SV Status

5-19-1 PV and SV Status Display Functions

● PV Status Display Function (Advanced Function Setting Level)

The PV on the No. 1 display in the PV, PV/SP, PV/Manual MV, or PV/SP Manual MV Display and the control or alarm status specified for the PV status display function are alternately displayed in 0.5-s cycles.

- PV
- PV/SP*
- PV/Manual MV
- PV/SP/Manual MV

* This includes when the PV/SP is selected for the Monitor/Setting Item parameter.

Set value	Display	Function
OFF	<i>OFF</i>	No PV status display
Manual	<i>MANU</i>	MANU is alternately displayed during manual control.
Stop	<i>STOP</i>	STOP is alternately displayed while operation is stopped.
Alarm 1	<i>ALM1</i>	ALM1 is alternately displayed during Alarm 1 status.
Alarm 2	<i>ALM2</i>	ALM2 is alternately displayed during Alarm 2 status.
Alarm 3	<i>ALM3</i>	ALM3 is alternately displayed during Alarm 3 status.
Alarm 4	<i>ALM4</i>	ALM4 is alternately displayed during Alarm 4 status.
Alarm 1 to 4 OR status	<i>ALM</i>	ALM is alternately displayed when Alarm 1, 2, 3, or 4 is set to ON.
Heater Alarm	<i>HA</i>	HA is alternately displayed when an HB alarm or HS alarm is ON.

Note: The default is OFF.

Example: When STOP Is Selected for the PV Status Display Function

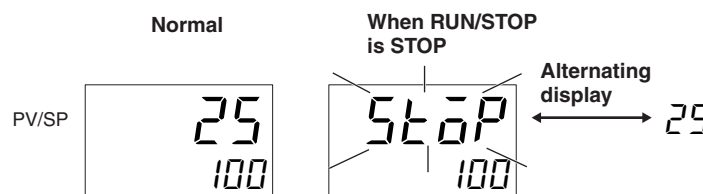

● SV Status Display Function (Advanced Function Setting Level)

The SP, Manual MV, or blank on the No. 2 display in the PV/SP, PV, or PV/Manual MV Display and the control or alarm status specified for the SV status display function are alternately displayed in 0.5-s cycles.

- PV
- PV/SP*
- PV/Manual MV
- PV/SP/Manual MV

* This includes when the PV/SP is selected for the Monitor/Setting Item parameter.

Set value	Display	Function
OFF	<i>OFF</i>	No SV status display
Manual	<i>MANU</i>	MANU is alternately displayed during manual control.
Stop	<i>STOP</i>	STOP is alternately displayed while operation is stopped.
Alarm 1	<i>ALM1</i>	ALM1 is alternately displayed during Alarm 1 status.
Alarm 2	<i>ALM2</i>	ALM2 is alternately displayed during Alarm 2 status.
Alarm 3	<i>ALM3</i>	ALM3 is alternately displayed during Alarm 3 status.

Set value	Display	Function
Alarm 4	ALM4	ALM4 is alternately displayed during Alarm 4 status.
Alarm 1 to 4 OR status	ALM	ALM is alternately displayed when Alarm 1, 2, 3, or 4 is set to ON.
Heater Alarm	HR	HA is alternately displayed when an HB alarm or HS alarm is ON.

Note: The default is OFF.

Example: When ALM1 Is Selected for the SV Status Display Function

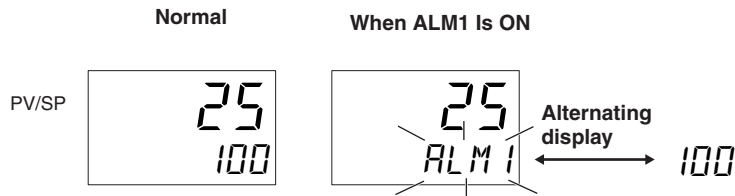

Additional Information

Priority of Flashing and Alternating Displays on No. 2 Display

The priority for flashing and alternating displays is as follows:

- (1) Alternating display with SV status display
- (2) Alternating display during program end output

The following procedure sets the PV Status Display Function parameter to ALM1.

Operating Procedure

<p>1 Press the Key several times in the Advanced Function Setting Level to display <i>PVSt</i> (PV Status Display Function).</p>	<p>Advanced Function Setting Level</p> <p>PV Status Display Function</p>
<p>2 Press the or Key to select <i>ALM 1</i> (alarm 1). The default is <i>OFF</i>.</p>	
<p>3 If the Alarm 1 status is ON in Operation Level, the PV and <i>ALM 1</i> (Alarm 1) will be alternately displayed.</p>	<p>Operation Level</p>

5-20 Communications with a Host Device (e.g., a PLC)

You can send communications command from a host device (e.g., a PLC) to the E5CC/E5EC to set parameters and monitor values, such as writing the SP or reading the PV. This function can be used only for a Controller that supports communications.

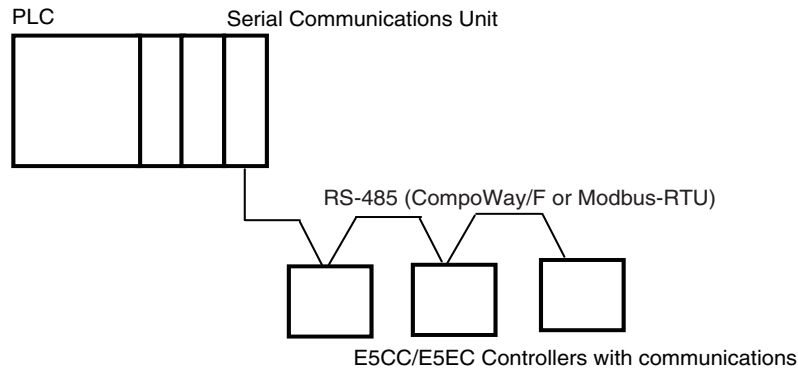

The communications command protocol can be selected from the following protocols.



Communications protocol	Description
CompoWay/F	CompoWay/F is OMRON's standard communications format for general serial communications. This format uses a standard frame format as well as the well-established FINS* commands used for OMRON's PLCs. Therefore, it can simplify communications between components and the host. * FINS (Factory Interface Network service) The FINS protocol provides message communications between controllers in OMRON FA networks.
Modbus-RTU	Modbus is a standard communications control method that conforms to the Modicon Company's RTU-mode Modbus Protocol (PI-MBUS-300 Revision J). Modbus is a registered trademark of Schneider Electric. It supports functions equivalent to the CompoWay/F Read Variable Area, Write Variable Area, Operation Command, and Echoback Test functions.

An overview on how to use communications is provided below.

Refer to the *E5CC/E5EC Digital Temperature Controllers Communications Manual* (Cat. No. H175) for detailed information on communications.

The settings are made in the Communications Setting Level.

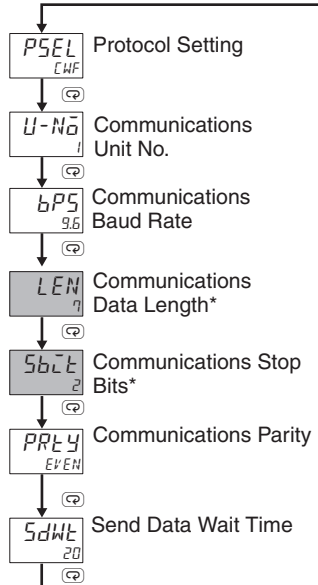
Operating Procedure

<p>1 Press the  Key in the Communications Setting Level to move between the following parameters</p> <ul style="list-style-type: none"> • <i>PSEL</i> Protocol Setting • <i>U-N\bar{o}</i> Communications Unit No. • <i>bPS</i> Communications Baud Rate • <i>LEN</i> Communications Data Length • <i>Sb$\bar{c}$$\bar{l}$$\bar{t}$</i> Communications Stop Bits • <i>PR$\bar{t}$$\bar{y}$</i> Communications Parity • <i>Sd$\bar{w}$$\bar{t}$</i> Send Data Wait Time 	
<p>2 Use the  or  Key to set these parameters.</p>	

* The Protocol Setting parameter is displayed only when CompoWay/F communications are being used.

Set the communications parameters to agree with the specifications of the host device (e.g., a PLC). If a 1:N connection is being used, make sure that the communications specifications for all devices in the system (except the communications unit numbers) are the same.

Communications Wiring

Connect the host device and the E5CC/E5EC with RS-485 wiring.

Sending Communications Commands

Communications commands are sent from the host device to the E5CC/E5EC by executing communications instructions. The E5CC/E5EC returns responses.

● **Communications Parameters**

Parameter	Parameter Display	Setting Display	Settings	Default	Level
Protocol Setting	<i>PSEL</i>	<i>CWF M$\bar{o}$$\bar{d}$</i>	CompoWay/F/Modbus	<i>CWF</i>	Communications Setting Level
Communications Unit No.	<i>U-N\bar{o}</i>	0 to 99	0 to 99	<i>1</i>	
Communications Baud Rate	<i>bPS</i>	9.6/19.2/38.4/57.6 (kbps)	9.6/19.2/38.4/57.6 (kbps)	<i>9.6</i>	
Communications Data Length	<i>LEN</i>	7/8 (bits)	7/8 (bits)	<i>7</i>	
Communications Stop Bits	<i>Sb$\bar{c}$$\bar{t}$</i>	1/2	1/2	<i>2</i>	
Communications Parity	<i>PR$\bar{t}$$\bar{y}$</i>	<i>N$\bar{o}$$\bar{n}$$\bar{e}$ EV$\bar{E}$$\bar{N}$ $\bar{o}$$\bar{d}$$\bar{d}$</i>	None, Even, or Odd	<i>EV$\bar{E}$$\bar{N}$</i>	
Send Data Wait Time	<i>Sd$\bar{w}$$\bar{t}$</i>	0 to 99	0 to 99 (ms)	<i>20</i>	

5-21 Using a Remote SP

A remote SP uses a remote SP input that is scaled between the remote SP upper and lower limits as the SP. (The remote SP can be 4 to 20 mA DC, 0 to 20 mA DC, 1 to 5 VDC, 0 to 5 VDC, or 0 to 10 VDC.) Set the Remote SP Enable parameter (Advanced Function Setting Level) to ON and select a remote SP in the SP Mode parameter (Adjustment Level) to enable using a remote SP. You can also use an event input to switch to SP Mode.

Parameter	Setting range	Unit	Default	Level
Remote SP Enable (<i>RSPU</i>)	OFF: Disable, ON: Enable	None	OFF	Advanced Function Setting Level
Remote SP Input (<i>RSt</i>)	4 to 20 mA DC, 0 to 20 mA DC, 1 to 5 VDC, 0 to 5 VDC, or 0 to 10 VDC	---	4 to 20 mA DC	Advanced Function Setting Level
Remote SP Upper Limit (<i>RSPH</i>)	Temperature input: Input setting range lower limit to Input setting range upper limit	EU	1300	Advanced Function Setting Level
Remote SP Lower Limit (<i>RSPL</i>)	Analog input: Scaling lower limit to Scaling upper limit	EU	-200	Advanced Function Setting Level
SP Tracking (<i>SPTR</i>)	OFF: Disable, ON: Enable	None	OFF	Advanced Function Setting Level
SP Mode (<i>SPMd</i>)	LSP: Local SP, RSP: Remote SP	None	LSP	Adjustment Level
Remote SP Monitor (<i>RSP</i>)	Remote SP lower limit -10% to Remote SP upper limit +10%	EU	---	Adjustment Level
Remote SP Input Shift (<i>RSS</i>)	Temperature input: -199.9 to 999.9	°C or °F	0.0	Adjustment Level
	Analog input: -1,999 to 9,999	EU	0	
Remote SP Input Slope Coefficient (<i>RSPt</i>)	0.001 to 9.999	EU	1.000	Adjustment Level



Precautions for Correct Use

- When the ST (self-tuning) parameter is turned ON, the SP Mode parameter is forcibly set to LSP.
- The remote SP input is not accepted during autotuning. Autotuning is executed for the remote SP at the beginning of autotuning.
- Changes in the remote SP value are not used as conditions for resetting the standby sequence.

● Remote SP Scaling

- You can scale the remote SP input for the PV input range with the remote SP upper and lower limits.
- The remote SP input can be from the remote SP lower limit -10% to the remote SP upper limit +10%. Input values outside of this range are treated as out-of-range input values (RSP input errors) and clamped to the upper or lower limit. The RSP indicator will flash in Remote SP Mode and the Remote SP Monitor will flash on the No. 2 display in any SP Mode.
- When you use the remote SP input value as the control SP, it is restricted by the set point upper limit and the set point lower limit.

Remote SP Input of 4 to 20 mA

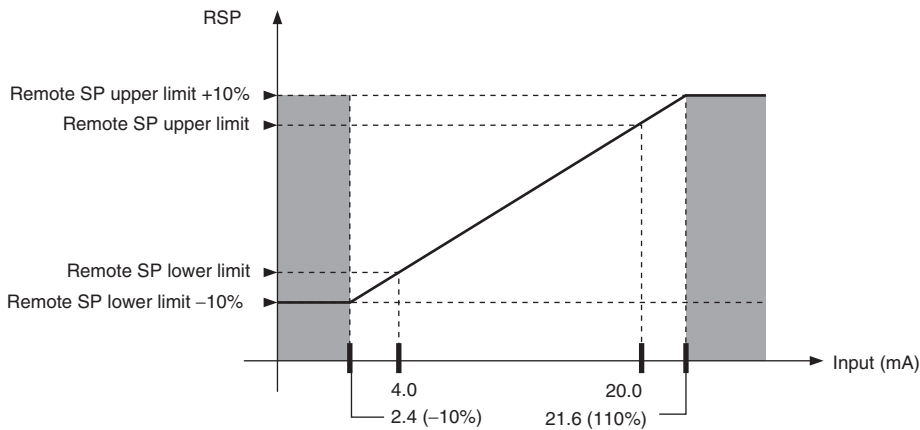

● **SP Mode**

The SP mode is used to switch between local SP and remote SP. When a remote SP is selected in SP mode, the RSP single indicator will light.

● **Remote SP Monitor**

- You can check the remote SP input value in the Remote SP Monitor parameter (Adjustment Level).
- If a remote SP is selected for the SP Mode parameter, the remote SP input value will be displayed as the SP in PV/SP displays. This remote SP input value will be restricted as the control SP by the set point upper limit and the set point lower limit.

● **SP Tracking**

- If the SP tracking function is enabled, the local SP inherits the remote SP value after switching from remote SP to local SP. To enable the SP tracking function, set the SP Tracking parameter to ON.
- SP tracking operates as follows:

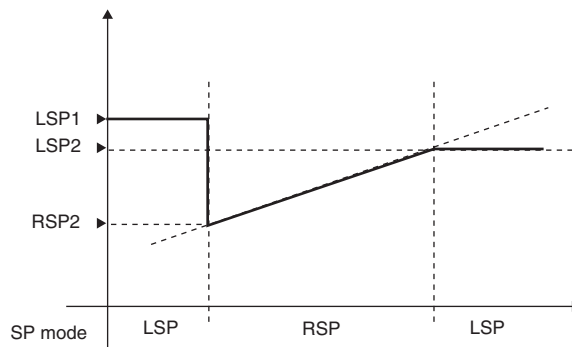

- (1) Switching to remote SP when the SP is LSP1 will result in switching to RSP2.
- (2) The operation will proceed according to remote SP inputs.
- (3) If the SP tracking function is enabled, the SP will become LSP2 after switching to local SP. If the SP tracking function is disabled, the SP will remain as LSP1.

- If the SP ramp function is enabled when switching from local SP to remote SP, SP tracking will operate.

● **Remote SP Input Compensation**

You can set a remote SP input shift and an SP input slope compensation coefficient to compensate the remote SP input.

5-22 Logic Operations

5-22-1 The Logic Operation Function (CX-Thermo)

- The logic operation function logically calculates as 1 or 0 the Controller status (alarms, SP ramp, RUN/STOP, auto/manual, etc.) and the external event input status, and outputs the results to work bits. The work bit status can be output to auxiliary or control outputs, and operating status can be switched according to the work bit status.
- Work bit logic operation can be set from 1 to 8. Set them to *No operation (Always OFF)* (the default) when the work bits are not to be used.
- When logic operations are being used, a dot will be displayed between the first two digits on the No. 2 display of the Adjustment Level display

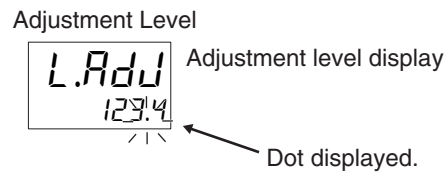

Note: The four numeric digits to identify the product code are displayed in the No. 2 display.

5-22-2 Using Logic Operations

Logic operations are set using the CX-Thermo.

● Starting Logic Operations

There are two ways to start logic operations.

- Select *Logic Operation Editor* from the CX-Thermo tree, and click the **Start** Button.

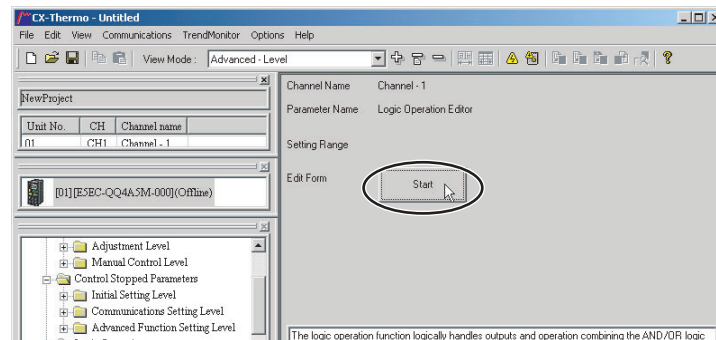

- Select *Logic Operation Editor* from the CX-Thermo Options Menu.

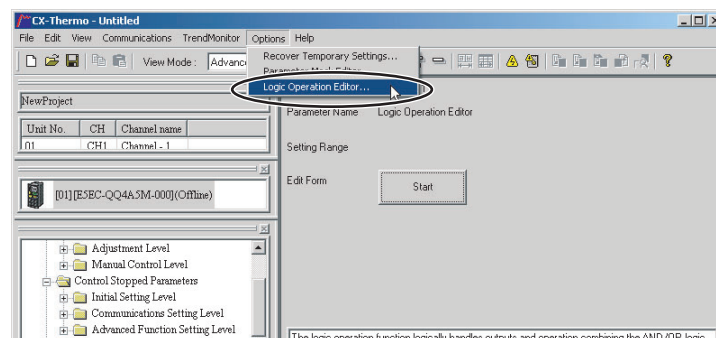

● **Making the Settings**

The following display will appear on the Logic Operation Editor Setting Window. Set each of the parameters.

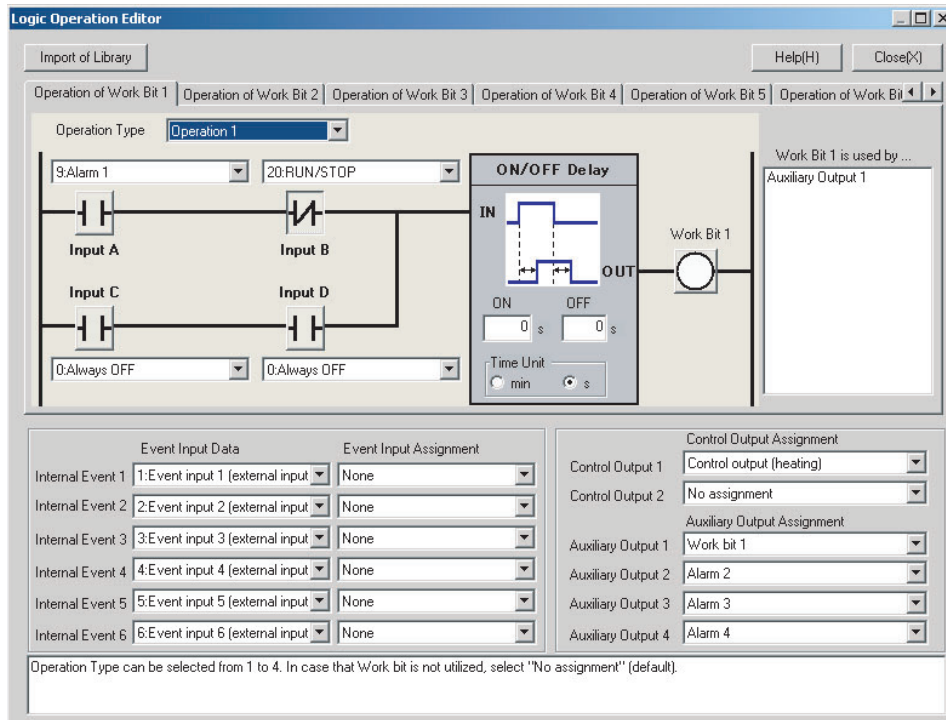

(1) Displaying the Library Import Dialog Box

Logic operation samples for specific cases are set in the library in advance. Examples of settings for specific cases are loaded by selecting them from the library list and clicking the **OK** Button.

Example: Selecting Library 1

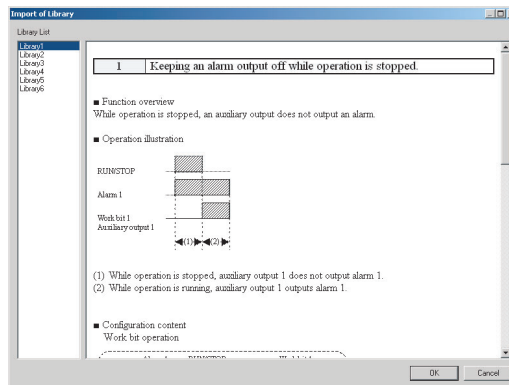

(2) Switching Work Bit Operations

Select the work bit logic operations from the Operation of Work Bit 1 to Operation of Work Bit 8 Tab Pages.

(3) Selecting the Operation Type

From one to four operations are supported. If work bits are not to be used, set them to *No operation (Always OFF)* (the default).

- No operation (Always OFF)

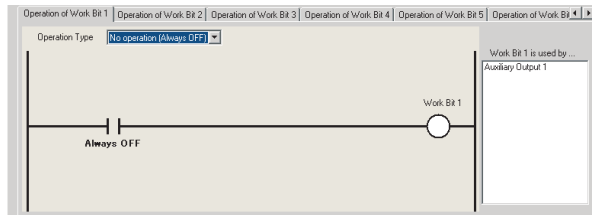

- Operation 1

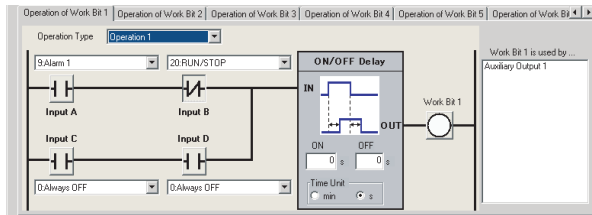

(A and B) or (C and D)
When conditions A and B or conditions C and D are satisfied

- Operation 2

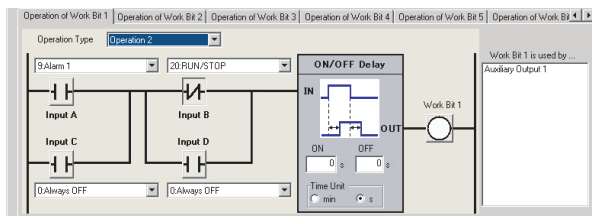

(A or C) and (B or D)
When condition A or C and condition B or D are satisfied

- Operation 3

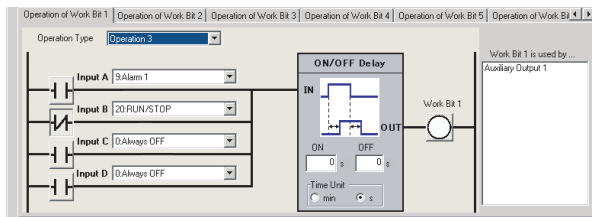

A or B or C or D
When condition A, B, C or D is satisfied

- Operation 4

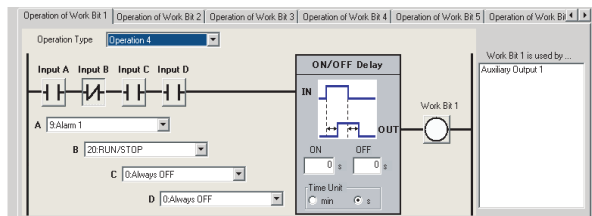

A and B and C and D
When conditions A, B, C and D are all satisfied

(4) Selecting Input Assignments



Select the input assignment for the work bit logic operation from the following settings.

Parameter name	Setting range
Work Bit 1 Input Assignment A	0. Always OFF
	1. Always ON
	2. ON for one cycle when power is turned ON
	3. Event input 1 (external input)*
	4. Event input 2 (external input)*
	5. Event input 3 (external input)*
	6. Event input 4 (external input)*
	7. Event input 5 (external input)*
	8. Event input 6 (external input)*
	9. Alarm 1
	10. Alarm 2
	11. Alarm 3
	12. Alarm 4
	13. Control output (heating)
	14. Control output (cooling)
	15. Input error
	16. RSP input error
	17. HB (heater burnout) alarm
	18. HS alarm
	19. Auto/Manual
	20. RUN/STOP
	21. RSP/LSP
	22. Program start
	23. AT Execute/Cancel
	24. SP ramp operating
	25. Multi-SP No. switching bit 0
	26. Multi-SP No. switching bit 1
	27. Multi-SP No. switching bit 2
	28. Program end output
	29. Work bit 1
	30. Work bit 2
	31. Work bit 3
	32. Work bit 4
	33. Work bit 5
	34. Work bit 6
	35. Work bit 7
36. Work bit 8	
Work Bit 1 Input Assignment B	Same as for work bit 1 input assignment A
Work Bit 1 Input Assignment C	Same as for work bit 1 input assignment A
Work Bit 1 Input Assignment D	Same as for work bit 1 input assignment A
to	to
Work Bit 8 Input Assignment D	Same as for work bit 1 input assignment A

* The event inputs that can be used depend on the Controller model.



(5) Switching between Normally Open and Normally Closed for Inputs A to D

Click the condition to switch between normally open and normally closed inputs A to D.

Normally open	Normally closed
	

(6) Switching between Normally Open and Normally Closed for Work Bits

Click the condition to switch between normally open and normally closed work bits.

Normally open	Normally closed
	

(7) Setting ON Delay Times

When an input with ON delay turns ON, the output will turn ON after the set delay time has elapsed. The setting range is 0 to 9,999. The default is 0 (disabled).

(8) Setting OFF Delay Times

When an input with OFF delay turns OFF, the output will turn OFF after the set delay time has elapsed. The setting range is 0 to 9,999. The default is 0 (disabled).

(9) Switching ON/OFF Delay Time Unit

Select either seconds or minutes for the ON/OFF delay time unit. The default is seconds. If the Work Bit * Operation Type is set to anything but OFF, the Work Bit * ON Delay and Work Bit * OFF Delay will be displayed in the Adjustment Level and the settings can be changed with key operations.

(10) Changing Event Input Data

Select the event input conditions from the following setting ranges.

Parameter name	Setting range
Internal event 1	0. Not assigned.
	1. Event input 1 (external input)
	2. Event input 2 (external input)
	3. Event input 3 (external input)
	4. Event input 4 (external input)
	5. Event input 5 (external input)
	6. Event input 6 (external input)
	7. Work bit 1
	8. Work bit 2
	9. Work bit 3
	10. Work bit 4
	11. Work bit 5
	12. Work bit 6
	13. Work bit 7
14. Work bit 8	
Internal event 2	Same as for Event Input Data 1.
Internal event 3	Same as for Event Input Data 1.
Internal event 4	Same as for Event Input Data 1.
Internal event 5	Same as for Event Input Data 1.
Internal event 6	Same as for Event Input Data 1.

Note: The internal event data can be changed from the default setting even if there is no event input terminal (external input). By changing the default setting, the event input assignment parameters will be displayed at the Controller display and can be set from the Controller.

(11) Changing the Event Input Assignment Function

Select the setting for the internal event assignment.

When a work bit is selected as event input data, Communications Write Enable/Disable cannot be assigned to an event input.

(12) Changing Control Output and Auxiliary Output Settings

Control output and auxiliary output assignments can be changed. The items that can be changed depend on the Controller model. For details, refer to *4-6 Setting Output Specifications*.

Assigning a work bit to either a control output or to an auxiliary output is also considered to be the same as assigning an alarm. For example, if work bit 1 is set for the Auxiliary Output 1 Assignment parameter, then alarms 1 to 4 have been assigned.

(13) Displaying Parameter Guides

A description of the parameters can be displayed.

(14) Displaying the Work Bit Use Destinations

Display a list of destinations where the work bits are used.

Operating Procedure

This procedure uses event input 2 to change to RUN or STOP.
 Event input 2 ON: RUN
 Event input 2 OFF: STOP

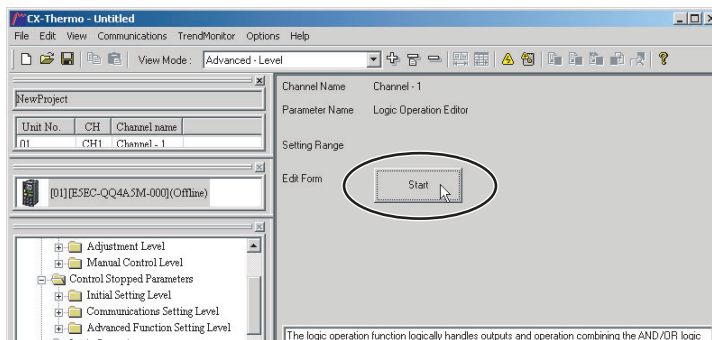
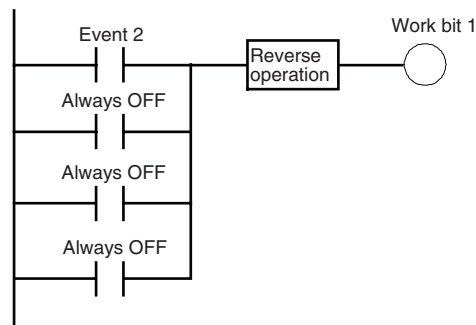

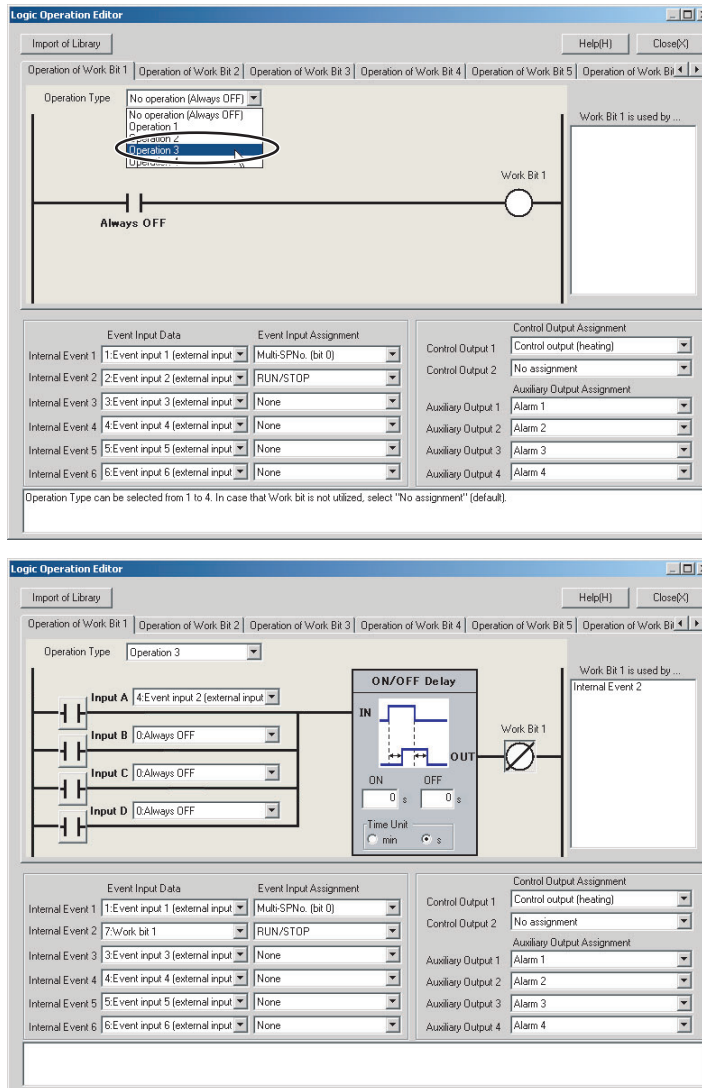

1. Select *Logic Operation Editor* from the CX-Thermo tree, and click the **Start** Button.



2. The Logic Operation Editor will be displayed. Confirm that the screen for work bit 1 is displayed, and select *Operation 3* from the *Operation Type* Field.

3. Set the operation by selecting one of the following:
 Work bit 1 input assignment A = 4: Event input 2 (external input)
 Work bit 1 input assignment B = 0: Always OFF
 Work bit 1 input assignment C = 0: Always OFF
 Work bit 1 input assignment D = 0: Always OFF

4. Invert work bit 1. Click  (Normally open) to change it to .

5. Assign RUN/STOP to event input 2. Set "5: Work bit 1" for the event input data for event input 2, and set "RUN/STOP" for the assignment function.

6. Closing the Logic Operation Editor Dialog Box
 Click the **Close** Button.
 This completes the procedure for setting parameters using the CX-Thermo. Transfer the settings to the Controller to set the Controller. Refer to CX-Thermo help for the procedure to transfer the settings.

Operating Procedure

This procedure outputs alarm 1 status to auxiliary output 1 during operation (RUN). A library object is used to make the setting.

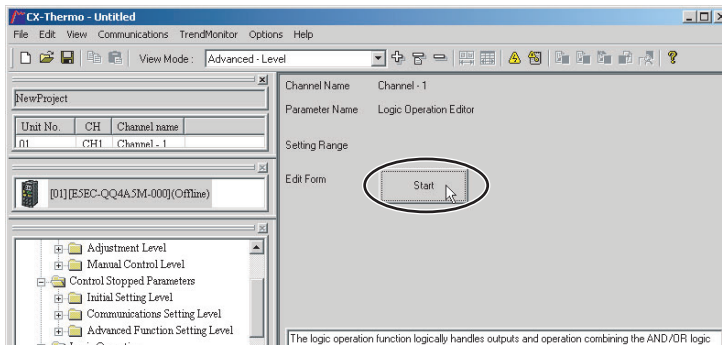
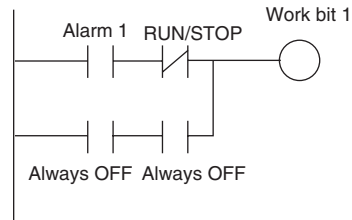

1. Select **Logic Operation Editor** from the CX-Thermo tree, and click the **Start** Button.

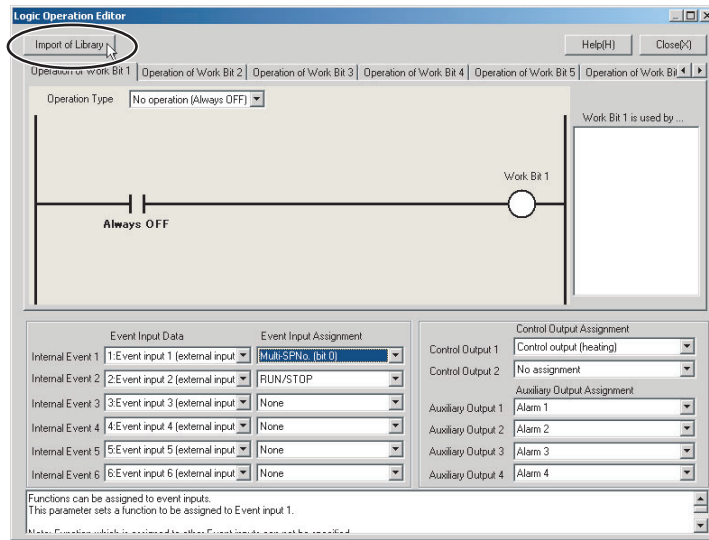

2. Click the **Import of Library** Button.

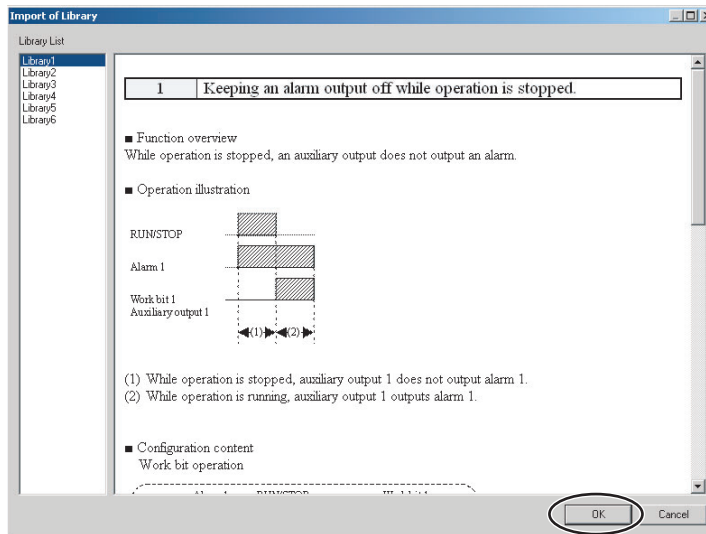

3. Select *Library 1* from the library list, and then click the **OK** Button.

Confirm the following settings, and then click the **OK** Button.

Work bit 1 operation type:
Operation 1

Work bit 1 input assignment
A = 7: Alarm 1

Work bit 1 input assignment
B = 19: Invert for RUN/STOP

Work bit 1 input assignment
C = 0: Always OFF

Work bit 1 input assignment
D = 0: Always OFF

Auxiliary output 1 = Work bit 1

4. Closing the Logic Operation Editor Dialog Box
Click the **Close** Button.

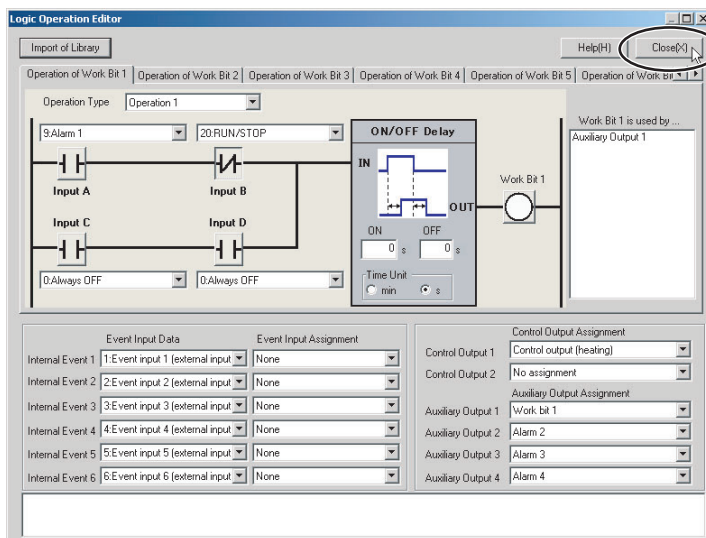

This completes the procedure for setting parameters using the CX-Thermo. Transfer the settings to the Controller to set the Controller. Refer to CX-Thermo help for the procedure to transfer the settings.

6

Parameters

6-1 Conventions Used in this Section	6-2
6-2 Protect Level	6-3
6-3 Operation Level	6-7
6-4 Adjustment Level	6-17
6-5 Monitor/Setting Item Level	6-35
6-6 Manual Control Level	6-36
6-7 Initial Setting Level	6-38
6-8 Advanced Function Setting Level	6-54
6-9 Communications Setting Level	6-84

6-1 Conventions Used in this Section

● Meanings of Icons Used in this Section



Function

Describes the functions of the parameter.



Setting

Describes the setting range and default of the parameter.



Monitor

Used to indicate parameters used only for monitoring.



Operation

Describes the parameter settings, such as those for Operation Commands, and procedures.



See

Used to indicate information on descriptions in which the parameter is used or the names of related parameters.

● About Related Parameter Displays

Parameters are displayed only when the conditions for use given on the right of the parameter heading are satisfied. Protected parameters are not displayed regardless of the conditions for use, but the settings of these parameters are still valid.

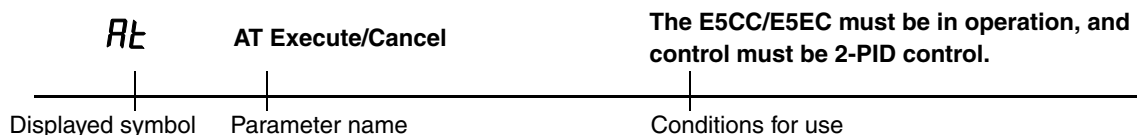

● The Order of Parameters in This Section

Parameters are described level by level.

The first page of each level describes the parameters in the level and the procedure to switch between parameters.

● Alarms

It will be specified in this section when alarms are set for the Control Output 1 or 2 Assignment parameters, or for the Auxiliary Output 1 to 4 Assignment parameters. For example, when alarm 1 is set for the Control Output 1 Assignment parameter, it will be specified that alarm 1 is assigned.

Assigning a work bit to either control output 1 or 2 or to auxiliary output 1 to 4 is also considered to be the same as assigning an alarm. For example, if work bit 1 is set for the Auxiliary Output 1 Assignment parameter, then alarms 1 to 4 have been assigned.

6-2 Protect Level

Four levels of protection are provided on the E5CC/E5EC, operation/adjustment protect, initial setting/communications protect, setting change protect, and PF key protect. These protect levels prevent unwanted operation of the keys on the front panel in varying degrees.

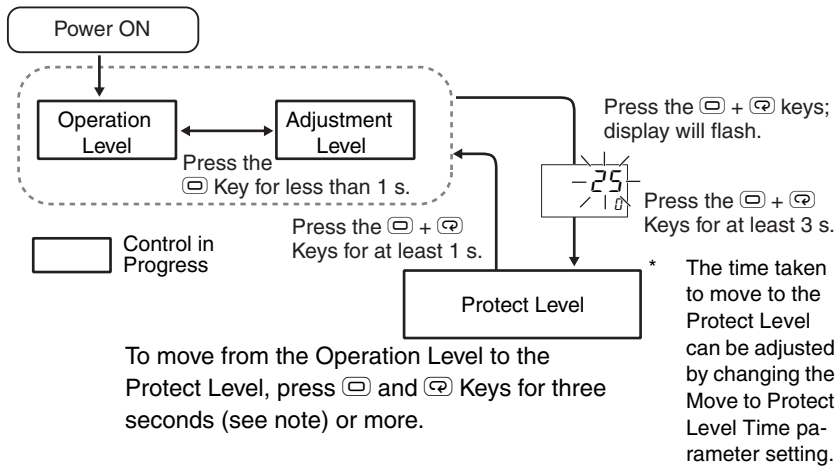

To move from the Operation Level to the Protect Level, press [Enter] and [F2] Keys for three seconds (see note) or more.

Protect Level	Page
$PM\bar{O}V$ Move to Protect Level Displayed only when a password is set.	6-3
$\bar{O}APL$ Operation/Adjustment Protect	6-4
$\bar{I}CP$ Initial Setting/Communications Protect	6-4
WLP Setting Change Protect	6-5
$PFPL$ PF Key Protect	6-5
$CHOP$ Changed Parameters Only	6-5
$PMSK$ Parameter Mask Enable Displayed only when a parameter mask is set.	6-6
$PRLP$ Password to Move to Protect Level	6-6

Parameters that are protected will not be displayed and their settings cannot be changed.

$PM\bar{O}V$ Move to Protect Level

The Password to Move to Protect Level password must not be set to 0.

The password to move to the Protect Level is entered for this parameter.



- If the correct password is entered, the Operation/Adjustment Protect parameter is displayed.



● Related Parameters

Password to Move to Protect Level (Protect Level): page 6-6

OPPE **Operation/Adjustment Protect**

ICPE **Initial Setting/Communications Protect**

These parameters specify the range of parameters to be protected. Shaded settings are the defaults.



● Operation/Adjustment Protect

The following table shows the relationship between set values and the range of protection.



Level		Set value			
		0	1	2	3
Operation Level	PV	Can be displayed	Can be displayed	Can be displayed	Can be displayed
	PV/SP	Can be displayed and changed	Can be displayed and changed	Can be displayed and changed	Can be displayed
	Others	Can be displayed and changed	Can be displayed and changed	Cannot be displayed and moving to other levels is not possible	Cannot be displayed and moving to other levels is not possible
Adjustment Level		Can be displayed and changed	Cannot be displayed and moving to other levels is not possible	Cannot be displayed and moving to other levels is not possible	Cannot be displayed and moving to other levels is not possible

- Parameters are not protected when the set value is set to 0.

● Initial Setting/Communications Protect

This protect level restricts movement to the Initial Setting Level, Communications Setting Level, and Advanced Function Setting Level.

Set value	Initial setting level	Communications setting level	Advanced function setting level
0	Possible to reach	Possible to reach	Possible to reach
1	Possible to reach	Possible to reach	Not possible to reach
2	Not possible to reach	Not possible to reach	Not possible to reach

WEPE Setting Change Protect

The Event Input Assignment 1 to Event Input Assignment 6 parameters must not be set to enable/disable setting changes.

Changes to settings using key operations are restricted. The shaded cell indicates the default.



- **Change Setting Protect**

This parameter is not displayed if the Event Input Assignment 1 to Event Input Assignment 6 parameters are set to enable/disable setting changes.



Set value	Description
OFF	Settings can be changed using key operations.
ON	Settings cannot be changed using key operations. (The protect level settings, however, can be changed.)

- The all protect indication (**On**) will light when setting is ON.

PFPE PF Key Protect

- **PF Key Protect**

This parameter enables and disables PF Key operation.



Set value	Description
OFF	PF Key enabled
ON	PF Key disabled (Operation as a function key is prohibited.)

* The shaded cell indicates the default.

CHGP Changed Parameters Only

This parameter allows you to display only the parameters that have been changed from their default settings.



Setting range	Default
$\bar{0}N$: Enabled, $\bar{0}FF$: Disabled	$\bar{0}FF$

PMSk**Parameter Mask Enable**

This parameter is displayed only when a parameter mask has been set from the Setup Tool.



- This parameter turns the parameter mask function ON and OFF.







Setting range	Default
$\bar{a}N$: Enabled, $\bar{a}FF$: Disabled	$\bar{a}N$

- * A parameter mask can be used to hide the displays of parameters that are not needed. The parameter mask function is provided by the Setup Tool.
Setup Tool: CX-Thermo (EST2-2C-MV4)

PRLP**Password to Move to Protect Level**

This parameter is used to set the password to move to the Protect Level.



- To prevent setting the password incorrectly, the  and  Keys or  and  Keys must be pressed simultaneously to set the password.



Setting range	Default
-1999 to 9999	0

Set this parameter to 0 when no password is to be set.



- **Related Parameters**

Move to Protect Level (Protect Level): Page 6-3

**Precautions for Correct Use**

Protection cannot be cleared or changed without the password. Be careful not to forget it. If you forget the password, contact your OMRON sales representative.

6-3 Operation Level

Display this level to perform control operations on the E5CC/E5EC. You can set alarm values, monitor the manipulated variable, and perform other operations in this level.

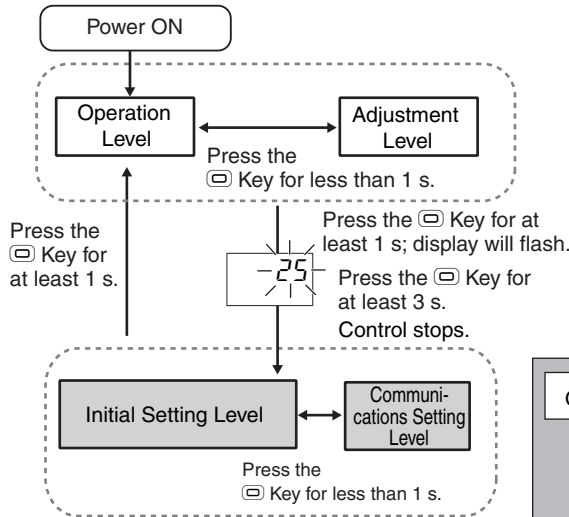

This level is displayed immediately after the power is turned ON.

 Control in progress
 Control stopped

Operation Level		Page	
[25]	Process Value/ Set Point 1	6-8	
[25]	Process Value/ Set Point 2	6-8	
R-M	Auto/Manual Switch	6-9	
M-SP	Multi-SP Set Point Selection	6-9	
RSP	Remote SP Monitor	6-9	
SP-M	Set Point During SP Ramp	6-10	
[E1]	Heater Current 1 Value Monitor	6-10	
[E2]	Heater Current 2 Value Monitor	6-11	
[L R 1]	Leakage Current 1 Monitor	6-11	
[L R 2]	Leakage Current 2 Monitor	6-12	
PRSt	Program Start	6-12	
SKtR	Soak Time Remain	6-13	
R-5	RUN/STOP	6-13	
AL-1	Alarm Value 1	6-14	
AL 1H	Alarm Value Upper Limit 1	6-15	
AL 1L	Alarm Value Lower Limit 1	6-15	
AL-2	Alarm Value 2	6-14	
AL 2H	Alarm Value Upper Limit 2	6-15	
AL 2L	Alarm Value Lower Limit 2	6-15	
AL-3	Alarm Value 3	6-14	
AL 3H	Alarm Value Upper Limit 3	6-15	
AL 3L	Alarm Value Lower Limit 3	6-15	
AL-4	Alarm Value 4	6-14	
AL 4H	Alarm Value Upper Limit 4	6-15	
AL 4L	Alarm Value Lower Limit 4	6-15	
[M]	MV Monitor (Heating)	6-16	
[C]	MV Monitor (Cooling)	6-16	

Process Value/Set Point 1

PV/SP No. 1 Display Selection must not be set to 0.

Process Value/Set Point 2

PV/SP No. 2 Display Selection must not be set to 0.



Function

The following table shows the contents of the No. 1, 2, and 3 displays, according to the setting of the PV/SP Display Selection parameter. (Only the E5EC has a No. 3 display.)



Setting

Set value	No. 1 display	No. 2 display	No. 3 display (E5EC only)
0	Nothing is displayed.	Nothing is displayed.	Nothing is displayed.
1	Process value	Set point	Nothing is displayed.
2	Process value	Nothing is displayed.	Nothing is displayed.
3	Set point	SP (character display)	Nothing is displayed.
4	Process value	Set point	Manipulated value
5	Process value	Set point	Multi-SP No.
6	Process value	Set point	Soak time remain
7	Process value	Set point	Internal set point (ramp SP)
8	Process value	Set point	Alarm value 1 ^{*1}

- *1 The set value of the Alarm Value 1 parameter is displayed even if it is not valid due to the setting of the Alarm 1 Type parameter.

	Monitor range	Unit
Process value	Temperature input: The specified range for the specified sensor. Analog input: Scaling lower limit -5% FS to Scaling upper limit +5% FS	EU

	Setting range	Unit
Set point	SP lower limit to SP upper limit	EU

For a temperature input, the decimal point position depends on the currently selected sensor, and for an analog input it depends on the Decimal Point parameter setting.

PV/SP Display Selections

Parameter	Default
PV/SP No. 1 Display Selection	4
PV/SP No. 2 Display Selection	0



See

● Related Parameters

PV/SP Display Selection (Advanced Function Setting Level): Page 6-81

R-M Auto/Manual Switch

The Event Input Assignment 1 to Event Input Assignment 6 parameters must not be set to Auto/Manual and the Auto/Manual Select Addition parameter must be set to ON. The control must be set to 2-PID control.



Operation

- This parameter switches the Controller between automatic and manual modes.
- If the  Key is pressed for at least 3 seconds when the Auto/Manual Switch parameter is displayed, the manual mode will be entered and the manual control level will be displayed.
- This parameter will not be displayed if an event input is set to "MANU" (auto/manual).



● **Related Parameters**

PID ON/OFF (Initial Setting Level): Page 6-41

Auto/Manual Select Addition (Advanced Function Setting Level): Page 6-67

M-SP Multi-SP Set Point Selection (Set Points 0 to 7)

The Number of Multi-SP Points parameter must not be set to OFF and the Event Input Assignment 1 to Event Input Assignment 6 parameters must not be set to "Multi-SP No. switching bit 0" to "Multi-SP No. switching bit 2."



Function

To use the multi-SP function, preset the eight set points (SP 0 to 7) in the Adjustment Level, and then switch the set point either by operating the keys or by using external input signals (event inputs).

This parameter is used to select set points 0 to 7.

RSP Remote SP Monitor

The ST parameter must be set to OFF.
The Remote SP Enable parameter must be set to ON.



Monitor

This parameter is used to monitor the remote SP.

Monitor range	Unit
Remote SP lower limit -10% to Remote SP upper limit +10%	EU



● **Related Parameters**

SP Mode (Adjustment Level): Page 6-20

Remote SP Enable (Advanced Function Setting Level): Page 6-75

Remote SP Upper Limit (Advanced Function Setting Level): Page 6-76

Remote SP Lower Limit (Advanced Function Setting Level): Page 6-76

SP-M Set Point During SP Ramp

The SP Ramp Set Value parameter must not be set to OFF and the SP Ramp Fall Value parameter must not be set to SAME or OFF. The ST parameter must be set to OFF.

This parameter monitors the set point during SP ramp operation.



A ramp is used to restrict the change width of the set point as a rate of change. This parameter is displayed when a set value is input for the SP Ramp Set Value parameter (Adjustment Level).

When not in ramp operation, the set point will be the same as the one displayed for the Process Value/Set Point parameter.



Monitor range	Unit
SP: SP lower limit to SP upper limit	EU



● **Related Parameters**

- Process Value/Set Point (Operation Level): Page 6-8
- SP Ramp Set Value (Adjustment Level): Page 6-32
- SP Ramp Fall Value (Adjustment Level): Page 6-32
- Set Point Upper Limit (Initial Setting Level): Page 6-41
- Set Point Lower Limit (Initial Setting Level): Page 6-41

CT 1 Heater Current 1 Value Monitor

HB and HS alarms must be supported.
The HB ON/OFF parameter must be set to ON.

This parameter measures the heater current from the CT input used for detecting heater burnout.



This parameter measures and displays the heater current value.

- Heater burnout is not detected if the ON time for the control output for heating is 100 ms or less (30 ms or less if the control period is 0.1 or 0.2 s).



Monitor range	Unit
0.0 to 55.0	A

- FFFF is displayed when 55.0 A is exceeded.
- If an alarm is output for the Heater Burnout Detection 1 parameter, the No. 1 display will flash the Heater Current 1 Value Monitor parameter.



● **Related Parameters**

- Heater Burnout Detection 1 (Adjustment Level): Page 6-21
- Heater Burnout Detection 2 (Adjustment Level): Page 6-22
- HB ON/OFF (Advanced Function Setting Level): Page 6-58
- Error Display CT 1: Page A-12

CT2**Heater Current 2 Value Monitor****HB and HS alarms must be supported (two CTs).
The HB ON/OFF parameter must be set to ON.**

This parameter measures the heater current from the CT input used for detecting heater burnout.



Function

This parameter measures and displays the heater current value.

- Heater burnout is not detected if the ON time for the control output for heating is 100 ms or less (30 ms or less if the control period is 0.1 or 0.2 s).



Monitor

Monitor range	Unit
0.0 to 55.0	A

- *FFFF* is displayed when 55.0 A is exceeded.
- If an alarm is output for the Heater Burnout Detection 2 parameter, the No. 1 display will flash the Heater Current 2 Value Monitor parameter.



See

- **Related Parameters**

Heater Burnout Detection 1 (Adjustment Level): Page 6-21

Heater Burnout Detection 2 (Adjustment Level): Page 6-22

HB ON/OFF (Advanced Function Setting Level): Page 6-58

Error Display **CT2**: Page A-12

LCR1**Leakage Current 1 Monitor****HB and HS alarms must be supported.
The HS Alarm Use parameter must be set to ON.**

This parameter measures the heater current from the CT input used for detecting SSR short-circuits.



Function

The heater current is measured and the leakage current 1 monitor is displayed.

- The HS alarm is not detected if the OFF time for the control output for heating is 100 ms or less (35 ms or less if the control period is 0.1 or 0.2 s).



Monitor

Monitor range	Unit
0.0 to 55.0	A

- *FFFF* is displayed when 55.0 A is exceeded.
- If an alarm is output for the HS Alarm 1 parameter, the No. 1 display will flash the Leakage Current 1 Monitor parameter.



See

- **Related Parameters**

HS Alarm 1 (Adjustment Level): Page 6-23

HS Alarm 2 (Adjustment Level): Page 6-24

HS Alarm Use (Advanced Function Setting Level): Page 6-68

Error Display **LCR1**: Page A-12

LCR2**Leakage Current 2 Monitor**

**HB and HS alarms must be supported (two CTs).
The HS Alarm Use parameter must be set to ON.**

This parameter measures the heater current from the CT input used for detecting SSR short-circuits.



Function

This parameter measures and displays the heater current value.

- The HS alarm is not detected if the OFF time for the control output for heating is 100 ms or less (35 ms or less if the control period is 0.1 or 0.2 s).



Monitor

Monitor range	Unit
0.0 to 55.0	A

- *FFFF* is displayed when 55.0 A is exceeded.
- If an alarm is output for the HS Alarm 2 parameter, the No. 1 display will flash the Leakage Current 2 Monitor parameter.



● **Related Parameters**

HS Alarm 1 (Adjustment Level): Page 6-23

HS Alarm 2 (Adjustment Level): Page 6-24

HS Alarm Use (Advanced Function Setting Level): Page 6-68

Error Display *LCR2*: Page A-12

PRSt**Program Start**

The Program Pattern parameter must not be set to OFF.

This parameter starts and stops the simple program function.



Function

- The RUN/STOP status will automatically switch to RUN when this parameter is set to STRT.
- The simple program will stop when this parameter is set to RSET.
- This parameter will function as a monitor display for the start/stop status of the simple program if an event input is selected to start the simple program.



Operation

Setting range		Default
RSET	Stops the simpler program.	<i>RSET</i>
STRT	Starts the simpler program.	



● **Related Parameters**

Soak Time Remain (Operation Level): Page 6-13

RUN/STOP (Operation Level): Page 6-13

Soak Time (Adjustment Level): Page 6-30

Wait Band (Adjustment Level): Page 6-30

Program Pattern (Initial Setting Level): Page 6-43

Soak Time Unit (Advanced Function Setting Level): Page 6-74

SKET**Soak Time Remain****The Program Pattern parameter must not be set to OFF.**

- This parameter measures and displays the remaining time of the soak time for the simple program function.



Monitor range	Unit
0 to 9999	min or h



- **Related Parameters**

Program Start (Operation Level): Page 6-12

Soak Time (Adjustment Level): Page 6-30

Wait Band (Adjustment Level): Page 6-30

Program Pattern (Initial Setting Level): Page 6-43

Soak Time Unit (Advanced Function Setting Level): Page 6-74

R-5**RUN/STOP****The Event Input Assignment 1 to 6 parameters must not be set to RUN/STOP.**

This parameter starts and stops the control operation.



When *RUN* (RUN) is selected, control is started. When *STOP* (STOP) is selected, control is stopped. The STOP indicator will light when control is stopped.

The default is *RUN*.



This parameter will not be displayed if an event input is set to "RUN/STOP."

RL - 1 Alarm Value 1**RL - 2** Alarm Value 2**RL - 3** Alarm Value 3**RL - 4** Alarm Value 4

Alarm 1 to alarm 4 must be assigned.
The Alarm 1 to 4 Type parameters must not be set to 0, 1, 4, 5, or 12.

This parameter is set to one of the input values "X" in the alarm type list. (Page 3-16)



- These parameters set the alarm values for alarms 1 to 4.
- During temperature input, the decimal point position depends on the currently selected sensor, and during analog input it depends on the Decimal Point parameter setting.

Alarms Other Than an MV Alarm

Setting range	Unit	Default
-1999 to 9999	EU	0

MV Alarms

Setting range	Unit	Default
-199.9 to 999.9	%	0.0



● Related Parameters

- Input Type (Initial Setting Level): Page 6-39
- Scaling Upper Limit (Initial Setting Level): Page 6-40
- Scaling Lower Limit (Initial Setting Level): Page 6-40
- Decimal Point (Initial Setting Level): Page 6-40
- Alarm 1 to 4 Type (Initial Setting Level): Page 6-44
- Alarm 1 to 4 Hysteresis (Initial Setting Level): Page 6-48
- Standby Sequence Reset (Advanced Function Setting Level): Page 6-57
- Auxiliary Output 1 to 4 Open in Alarm (Advanced Function Setting Level): Page 6-58
- Alarm 1 to 4 Latch (Advanced Function Setting Level): Page 6-63

AL 1H Alarm Value Upper Limit 1**AL 2H** Alarm Value Upper Limit 2**AL 3H** Alarm Value Upper Limit 3**AL 4H** Alarm Value Upper Limit 4**AL 1L** Alarm Value Lower Limit 1**AL 2L** Alarm Value Lower Limit 2**AL 3L** Alarm Value Lower Limit 3**AL 4L** Alarm Value Lower Limit 4

Alarm 1 to alarm 4 must be assigned.
The Alarm 1 to 4 Type parameter must be set to 1, 4, or 5.

These parameters individually set the alarm value upper and lower limits when a mode for setting the upper and lower limits is selected for the Alarm 1 to 4 Type parameter (Initial Setting Level).



Function

- These parameters set the upper and lower limits for alarms 1 to 4.
- During temperature input, the decimal point position depends on the currently selected sensor, and during analog input it depends on the Decimal Point parameter setting.



Setting

Setting range	Unit	Default
-1999 to 9999	EU	0



See

● Related Parameters

- Input Type (Initial Setting Level): Page 6-39
- Scaling Upper Limit (Initial Setting Level): Page 6-40
- Scaling Lower Limit (Initial Setting Level): Page 6-40
- Decimal Point (Initial Setting Level): Page 6-40
- Alarm 1 to 4 Type (Initial Setting Level): Page 6-44
- Alarm 1 to 4 Hysteresis (Initial Setting Level): Page 6-48
- Standby Sequence Reset (Advanced Function Setting Level): Page 6-57
- Auxiliary Output 1 to 4 Open in Alarm (Advanced Function Setting Level): Page 6-58
- Alarm 1 to 4 Latch (Advanced Function Setting Level): Page 6-63

**MV Monitor (Heating)****The MV Display parameter must be set to ON.**

This parameter is used to monitor the manipulated variable for the heating control output during operation.



Function

- During standard control, the manipulated variable is monitored. During heating/cooling control, the manipulated variables on the control output (heating) is monitored.
- The default is OFF and the manipulated variable is not displayed.



Monitor

Control	Monitor range	Unit
Standard	-5.0 to 105.0	%
Heating/cooling	0.0 to 105.0	%

● **Related Parameters**

MV Display (Advanced Function Setting Level): Page 6-62

**MV Monitor (Cooling)****The control system must be set to heating/cooling control.****The MV Display parameter must be set to ON.**

This parameter is used to monitor the manipulated variable for the cooling control output during operation.



Function

- During heating/cooling control, the manipulated variable on the control output (cooling) is monitored.
- The default is OFF and the manipulated variable is not displayed.



Monitor

Control	Monitor range	Unit
Heating/cooling	0.0 to 105.0	%

● **Related Parameters**

Standard or Heating/Cooling (Initial Setting Level): Page 6-42

MV Display (Advanced Function Setting Level): Page 6-62

6-4 Adjustment Level

This level is for executing AT (auto-tuning) and other operations, and for set control parameters. This level provides the basic Controller parameters for PID control (proportional band, integral time, derivative time) and heating/cooling control.

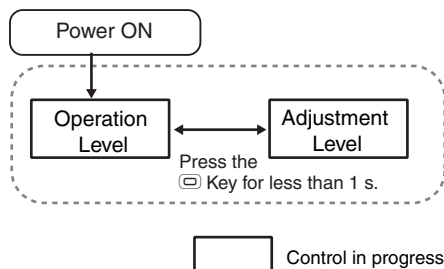

To move to the Adjustment Level from the Operation Level, press the  Key once.

- The set points 0 to 7 in the Adjustment Level are the set values for switching the set point during multi-SP input.
- The following items are displayed for Controllers with CT Inputs: Heater current monitors, Leakage current monitors, HB alarm detection, and HS alarm detection.
- Adjustment level parameters can be changed after setting the Operation/Adjustment Protect parameter to 0. Displays and changing levels are not possible if the Operation/Adjustment Protect parameter is set to 1 to 3. Protection is set in the Protect Level.

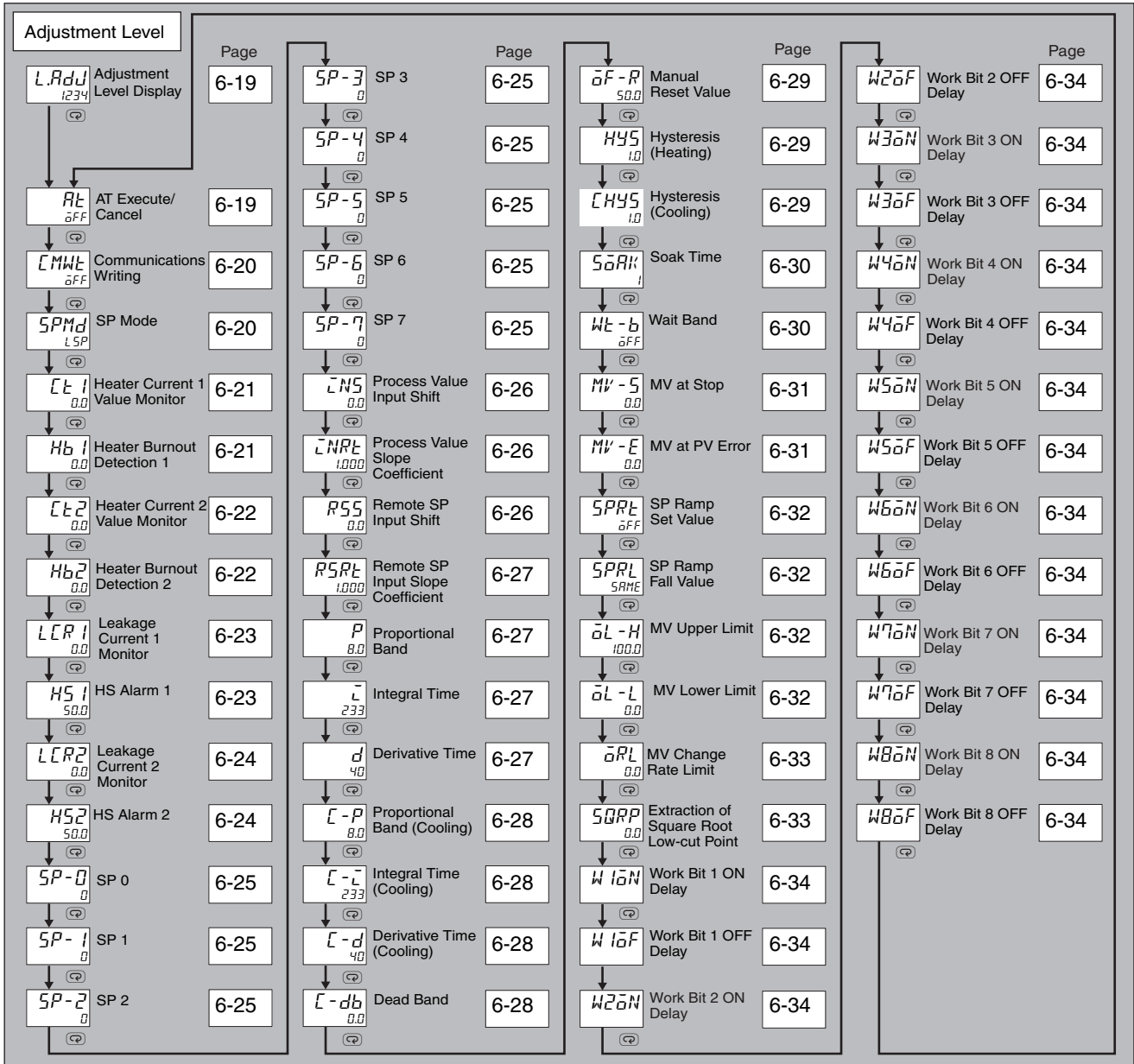

L.Adj Adjustment Level Display

This parameter is displayed after moving to the Adjustment Level. The four numeric digits to identify the product code are displayed in the No. 2 display.

When a logic operation is set, a period "." will be displayed on the No. 2. display.



- This parameter indicates that the Adjustment Level has been entered. (The Adjustment Level parameter will not be displayed again even if the  Key is pressed in the Adjustment Level to scroll through the parameters.)

AT AT Execute/Cancel

The E5CC/E5EC must be in operation, and control must be 2-PID control. Event Input Assignment 1 to Event Input Assignments 6 parameters must be other than 100% or 40% AT Execute/Cancel.

This parameter executes auto-tuning (AT).



- The MV is forcibly increased and decreased around the set point to find the characteristics of the control object. From the results, the PID constants are automatically set in the Proportional Band (P), Integral Time (I), and Derivative Time (D) parameters.
- Both 100% AT and 40% AT are supported for AT. Only 100% AT can be executed for heating and cooling control.
- For heating/cooling control, select the tuning methods that is suitable for the cooling control characteristics in the Heating/Cooling Tuning Method parameter.
- If autotuning is performed with the default settings, the cooling PID constants (i.e., Proportional Band (Cooling), Integral Time (Cooling), and Derivative Time (Cooling) parameters) have the same values as the heating PID constants.
- This parameter will not be displayed when either 100% or 40% AT execute/cancel is set to be executed using an event input.



	Setting range	Default
OFF:	AT Cancel	
AT-2:	100%AT Execute	OFF
AT-1:	40%AT Execute	

- This parameter is normally \bar{OFF} . Press the  Key and select $AT-2$ or $AT-1$ to execute AT. AT cannot be executed when control is stopped or during ON/OFF control.
- The TUNE indicator will light during autotuning.
- When AT execution ends, the parameter setting automatically returns to \bar{OFF} .



● Related Parameters

Proportional Band (Adjustment Level): Page 6-27

Integral Time (Adjustment Level): Page 6-27

Derivative Time (Adjustment Level): Page 6-27

Proportional Band (Cooling) (Adjustment Level): Page 6-28

Integral Time (Cooling) (Adjustment Level): Page 6-28

Derivative Time (Cooling) (Adjustment Level): Page 6-28

PID ON/OFF (Initial Setting Level): Page 6-41

Heating/Cooling Tuning Method (Advanced Function Setting Level): Page 6-78

CMWE Communications Writing

**Communications must be supported.
The Event Input Assignment 1 to Event Input
Assignment 6 parameters must not be set to
enable/disable communications writing.**



- This parameter enables/disables writing of parameters to the E5CC/E5EC from the host (personal computer) using communications.
- This parameter is not displayed if the Event Input Assignment 1 to Event Input Assignment 6 parameters are set to enable/disable communications writing.



Setting range		Default
ON:	Writing enabled	OFF
OFF:	Writing disabled	



- **Related Parameters**

- Communications Unit No. (Communications Setting Level): Page 6-84
- Communications Baud Rate (Communications Setting Level): Page 6-84
- Communications Data Length (Communications Setting Level): Page 6-84
- Communications Parity (Communications Setting Level): Page 6-84
- Communications Stop Bits (Communications Setting Level): Page 6-84

SPMd SP Mode

**The ST parameter must be set to OFF, and the
Remote SP Enable parameter must be set to ON.
The Event Input Assignment 1 to Event Input
Assignment 6 parameters must not be set to
change the SP mode.**



This parameter sets the SP mode. In Local SP Mode, the local SP that is set inside the Digital Controller is used as the SP. In Remote SP Mode, the remote SP that is specified with an external signal (e.g., 4 to 20 mA) is used as the SP.

Setting range	Default
LSP: Local SP and RSP: Remote SP	LSP



- **Related Parameters**

- Remote SP Enable (Advanced Function Setting Level): Page 6-75

ℓℓ 1**Heater Current 1 Value Monitor****HB and HS alarms must be supported.
The HB ON/OFF parameter must be set to ON.**

This parameter measures the heater current from the CT input used for detecting heater burnout.



This parameter measures and displays the heater current value.

- Heater burnout is not detected if the ON time for the control output for heating is 100 ms or less (30 ms or less if the control period is 0.1 or 0.2 s).



Monitor range	Unit
0.0 to 55.0	A

- *FFFF* is displayed when 55.0 A is exceeded.
- If an alarm is output for the Heater Burnout Detection 1 parameter, the No. 1 display will flash the Heater Current 1 Value Monitor parameter.



- **Related Parameters**

- Heater Burnout Detection 1 (Adjustment Level): Page 6-21
- Heater Burnout Detection 2 (Adjustment Level): Page 6-22
- HB ON/OFF (Advanced Function Setting Level): Page 6-58
- Error Displays **ℓℓ 1**: Page A-12

Hb 1**Heater Burnout Detection 1****HB and HS alarms must be supported.
The HB ON/OFF parameter must be set to ON.**

This parameter sets the current for the heater burnout alarm to be output.



- The heater burnout alarm is output when the heater current value falls below the setting of this parameter.
- When the set value is 0.0, the heater burnout alarm output is turned OFF. When the set value is 50.0, the heater burnout alarm output is turned ON.



Setting range	Unit	Default
0.0 to 50.0	A	0.0



- **Related Parameters**

- Heater Current 1 Value Monitor (Adjustment Level): Page 6-21
- Heater Burnout Detection (Advanced Function Setting Level): Page 6-58
- Heater Burnout Latch (Advanced Function Setting Level): Page 6-59
- Heater Burnout Hysteresis (Advanced Function Setting Level): Page 6-59

CT2**Heater Current 2 Value Monitor****HB and HS alarms must be supported (two CTs).
The HB ON/OFF parameter must be set to ON.**

This parameter measures the heater current from the CT input used for detecting heater burnout.



This parameter measures and displays the heater current value.

- Heater burnout is not detected if the ON time for the control output for heating is 100 ms or less (30 ms or less if the control period is 0.1 or 0.2 s).



Monitor range	Unit
0.0 to 55.0	A

- *FFFF* is displayed when 55.0 A is exceeded.
- If an alarm is output for the Heater Burnout Detection 2 parameter, the No. 1 display will flash the Heater Current 2 Value Monitor parameter.



● Related Parameters

- Heater Burnout Detection 1 (Adjustment Level): Page 6-21
- Heater Burnout Detection 2 (Adjustment Level): Page 6-22
- Error Displays **CT2**: Page A-12

Hb2**Heater Burnout Detection 2****HB and HS alarms must be supported (two CTs).
The HB ON/OFF parameter must be set to ON.**

This parameter sets the current for the heater burnout alarm to be output.



- The heater burnout alarm is output when the heater current value falls below the setting of this parameter.
- When the set value is 0.0, the heater burnout alarm output is turned OFF. When the set value is 50.0, the heater burnout alarm output is turned ON.



Setting range	Unit	Default
0.0 to 50.0	A	0.0



● Related Parameters

- Heater Current 2 Value Monitor (Adjustment Level): Page 6-22
- HB ON/OFF (Advanced Function Setting Level): Page 6-58
- Heater Burnout Latch (Advanced Function Setting Level): Page 6-59
- Heater Burnout Hysteresis (Advanced Function Setting Level): Page 6-59

LCR 1 Leakage Current 1 Monitor

HB and HS alarms must be supported.
The HS Alarm Use parameter must be set to ON.

This parameter measures the heater current from the CT input used for detecting SSR short-circuits.



Function

This parameter measures and displays the heater current when the heater is OFF.

- The HS alarm is not detected if the OFF time for the control output for heating is 100 ms or less (35 ms or less if the control period is 0.1 or 0.2 s).



Monitor

Monitor range	Unit
0.0 to 55.0	A

- *FFFF* is displayed when 55.0 A is exceeded.
- If an alarm is output for the HS Alarm 1 parameter, the No. 1 display will flash the Leakage Current 1 Monitor parameter.



See

- **Related Parameters**

HS Alarm 1 (Adjustment Level): Page 6-23

HS Alarm 2 (Adjustment Level): Page 6-24

HS Alarm Use (Advanced Function Setting Level): Page 6-68

Error Displays *LCR 1*: Page A-12

HS 1 HS Alarm 1

HB and HS alarms must be supported.
The HS Alarm Use parameter must be set to ON.

This parameter sets the current for the HS alarm to be output.



Function

- An HS alarm is output when the leakage current value exceeds the setting of this parameter.
- When the set value is 50.0, the HS alarm output is turned OFF. When the set value is 0.0, the HS alarm output is turned ON.



Setting

Setting range	Unit	Default
0.0 to 50.0	A	50.0



See

- **Related Parameters**

Leakage Current 1 Monitor (Adjustment Level): Page 6-23

HS Alarm (Advanced Function Setting Level): Page 6-68

HS Alarm Latch (Advanced Function Setting Level): Page 6-69

HS Alarm Hysteresis (Advanced Function Setting Level): Page 6-69

LCR2**Leakage Current 2 Monitor**

**HB and HS alarms must be supported (two CTs).
The HS Alarm Use parameter must be set to ON.**

This parameter measures the heater current from the CT input used for detecting SSR short-circuits.



This parameter measures and displays the heater current when the heater is OFF.

- The HS alarm is not detected if the OFF time for the control output for heating is 100 ms or less (35 ms or less if the control period is 0.1 or 0.2 s).



Monitor range	Unit
0.0 to 55.0	A

- *FFFF* is displayed when 55.0 A is exceeded.
- If an alarm is output for the HS Alarm 2 parameter, the No. 1 display will flash the Leakage Current 2 Monitor parameter.



- **Related Parameters**

HS Alarm 1 (Adjustment Level): Page 6-23

HS Alarm 2 (Adjustment Level): Page 6-24

HS Alarm Use (Advanced Function Setting Level): Page 6-68

Error Displays *LCR2*: Page A-12

HS2**HS Alarm 2**

**HB and HS alarms must be supported (two CTs).
The HS Alarm Use parameter must be set to ON.**

This parameter sets the current for the HS alarm to be output.



- An HS alarm is output when the leakage current value exceeds the setting of this parameter.
- When the set value is 50.0, the HS alarm output is turned OFF. When the set value is 0.0, the HS alarm output is turned ON.



Setting range	Unit	Default
0.0 to 50.0	A	50.0



- **Related Parameters**

Leakage Current 2 Monitor (Adjustment Level): Page 6-24

HS Alarm Use (Advanced Function Setting Level): Page 6-68

HS Alarm Latch (Advanced Function Setting Level): Page 6-69

HS Alarm Hysteresis (Advanced Function Setting Level): Page 6-69

SP-0 SP 0**SP-1** SP 1**SP-2** SP 2**SP-3** SP 3**SP-4** SP 4**SP-5** SP 5**SP-6** SP 6**SP-7** SP 7

The Number of Multi-SP Points parameter must be set to 2 to 8 and the Event Input 1 Assignment to Event Input 6 Assignment parameters must not be set to “Multi-SP No. switching bit 0” to “Multi-SP No. switching bit 2.”

These parameters set the set points when the multi-SP function is used.



Function

The values set in these parameters can be selected by operating the keys on the front panel or by using event inputs.

- When the set point has been changed, the set value of the set point (0 to 7) selected by the multi-SP inputs is also changed to the same value.
- The decimal point position depends on the selected sensor. During analog input, it depends on the Decimal Point parameter setting.



Setting

Setting range	Unit	Default
SP lower limit to SP upper limit	EU	0



See

● Related Parameters

Process Value/Set Point (Operation Level): Page 6-8

Input Type (Initial Setting Level): Page 6-39

Event Input Assignment (Initial Setting Level): Page 6-51

Number of Multi-SP Points (Advanced Function Setting Level): Page 6-56

INS**Process Value Input Shift**

Sometimes an error occurs between the process value and the actual temperature. To offset this, a compensated value can be obtained by adding an input shift value to the input. The compensated value is displayed as the process value and used for control. The entire input range is shifted by a fixed rate. If the input shift value is set to -1°C , control will be performed for a value 1°C lower than the measured temperature.



Setting range	Unit	Default
Temperature input: -199.9 to 999.9	$^{\circ}\text{C}$ or $^{\circ}\text{F}$	0.0
Analog input: $-1,999$ to $9,999^*$	EU	0

* The decimal point position depends on the Decimal Point parameter setting.



- **Related Parameters**

Input Type (Initial Setting Level): Page 6-39

INRE**Process Value Slope Coefficient**

This parameter sets a factor to apply to the input to compensate the process value. The resulting value is displayed as the process value and used in control.



Setting range	Default
0.001 to 9.999	1.000

RSS**Remote SP Input Shift**

This parameter sets a compensation value to add to the remote SP input to compensate it. The compensated value is displayed as the process value and used in control.



Setting range	Unit	Default
Temperature input: -199.9 to 999.9	$^{\circ}\text{C}$ or $^{\circ}\text{F}$	0.0
Analog input: $-1,999$ to $9,999$	EU	0

* The decimal point position depends on the Decimal Point parameter setting.



- **Related Parameters**

Input Type (Initial Setting Level): Page 6-39

RSRt Remote SP Input Slope Coefficient



Function

This parameter sets a factor to apply to the remote SP input to compensate it. The resulting value is displayed as the remote SP input value and used in control.



Setting

Setting range	Default
0.001 to 9.999	1.000

P Proportional Band

I Integral Time The control must be set to 2-PID control.

d Derivative Time

These parameters set PID control constants. PID constants are automatically set when AT or ST is executed.



Setting

P Refers to control in which the MV is proportional to the deviation (control error).
action:

I Refers to a control action that is proportional to the time integral of the deviation.
action: With proportional control, there is normally an offset (control error). Proportional action is thus used in combination with integral action. As time passes, this control error disappears, and the control temperature (process value) comes to agree with the set point.

D Refers to a control action that is proportional to the time derivative of the control error.
action: The proportional control and integral control correct for errors in the control result, and thus the control system is late in responding to sudden changes in temperature. The derivative action increases the MV in proportion to the slope of the change in the temperature as a corrective action.



Setting

Parameter	Setting range	Unit	Default
Proportional Band	Temperature input	0.1 to 999.9	°C or °F
	Analog input		%FS
Integral Time *	Integral/Derivative Time Unit of 1 s	0 to 9999	Seconds
	Integral/Derivative Time Unit of 0.1 s	0.0 to 999.9	Seconds
Derivative Time *	Integral/Derivative Time Unit of 1 s	0 to 9999	Seconds
	Integral/Derivative Time Unit of 0.1 s	0.0 to 999.9	Seconds

* The unit is determined by the setting of the Integral/Derivative Time Unit parameter. The Proportional Band, Integral Time, and Derivative Time parameters are initialized if the Integral/Derivative Time Unit parameter is changed.



See

● Related Parameters

AT Execute/Cancel (Adjustment Level): Page 6-19

Integral/Derivative Time Unit (Advanced Function Setting Level): Page 6-60

[-P **Proportional Band (Cooling)**

[-I **Integral Time (Cooling)**

The control must be set to heating/cooling control and 2-PID control.

[-d **Derivative Time (Cooling)**



Function

These parameters set the PID constants for cooling control. These parameters are automatically set according to the Heating/Cooling Tuning Method parameter when AT or ST is executed.



Setting

Parameter	Setting range		Unit	Default
	Temperature input	0.1 to 999.9		
Proportional Band (Cooling)	Analog input		°C or °F	8.0
			%FS	10.0
Integral Time (Cooling) *	Integral/Derivative Time Unit of 1 s	0 to 9999	Seconds	233
	Integral/Derivative Time Unit of 0.1 s	0.0 to 999.9	Seconds	233.0
Derivative Time (Cooling)*	Integral/Derivative Time Unit of 1 s	0 to 9999	Seconds	40
	Integral/Derivative Time Unit of 0.1 s	0.0 to 999.9	Seconds	40.0

* The unit is determined by the setting of the Integral/Derivative Time Unit parameter. The Proportional Band (Cooling), Integral Time (Cooling), and Derivative Time (Cooling) parameters are initialized if the Integral/Derivative Time Unit parameter is changed.



● Related Parameters

AT Execute/Cancel (Adjustment Level): Page 6-19

Integral/Derivative Time Unit (Advanced Function Setting Level): Page 6-60

[-db **Dead Band**

The control system must be set to heating/cooling control.

This parameter sets the output dead band width for heating/cooling control. A negative setting sets an overlapping band.



Function

- This parameter sets an area in which the control output is 0 centering around the set point for a heating/cooling control.



Setting

	Setting range	Unit	Default
Temperature input	-199.9 to 999.9	°C or °F	0.0
Analog input	-19.99 to 99.99	%FS	0.00

OF-R**Manual Reset Value**

The control must be standard control and 2-PID control.
The Integral Time parameter must be set to 0.



Function

- This parameter sets the required manipulated variable to remove offset during stabilization of P or PD control.



Setting

Setting range	Unit	Default
0.0 to 100.0	%	50.0



See

● Related Parameters

- Integral Time (Adjustment Level): Page 6-27
PID ON/OFF (Initial Setting Level): Page 6-41

HYS
[HYS]**Hysteresis (Heating)**
Hysteresis (Cooling)

The control must be ON/OFF control.
For the Hysteresis (Cooling) parameter, the control must be heating/cooling control.

This parameter sets the hysteresis for ensuring stable operation at the ON/OFF switching point.



Function

- For standard control, use the Hysteresis (Heating) parameter. The Hysteresis (Cooling) parameter cannot be used.
- For heating/cooling control, the hysteresis can be set independently for heating/cooling. The Hysteresis (Heating) parameter is used for the heating side, and the Hysteresis (Cooling) parameter is used for the cooling side.



Setting

Parameter name	Setting range		Unit	Default
Hysteresis (Heating)	Temperature input	0.1 to 999.9	°C or °F	1.0
	Analog input	0.01 to 99.99	%FS	0.10
Hysteresis (Cooling)	Temperature input	0.1 to 999.9	°C or °F	1.0
	Analog input	0.01 to 99.99	%FS	0.10



See

● Related Parameters

- PID ON/OFF (Initial Setting Level): Page 6-41
Standard or Heating/Cooling (Initial Setting Level): Page 6-42

Soak**Soak Time****The Program Pattern parameter must not be set to OFF.**

- This parameter sets the time for the control operation when using the simple program function.



Setting range	Unit	Unit
1 to 9999	min or h	1



● Related Parameters

- Program Start (Operation Level): Page 6-12
- Soak Time Remain (Operation Level): Page 6-13
- Wait Band (Adjustment Level): Page 6-30
- Program Pattern (Initial Setting Level): Page 6-43
- Soak Time Unit (Advanced Function Setting Level): Page 6-74

WT - b**Wait Band****The Program Pattern parameter must not be set to OFF.**

- This parameter sets the stable band within which the soak time is measured for the simple program function.



	Setting range	Unit	Unit
Temperature input	OFF or 0.1 to 999.9	°C or °F	off
Analog input	OFF or 0.01 to 99.99	%FS	



● Related Parameters

- Program Start (Operation Level): Page 6-12
- Soak Time Remain (Operation Level): Page 6-13
- Soak Time (Adjustment Level): Page 6-30
- Program Pattern (Initial Setting Level): Page 6-43
- Soak Time Unit (Advanced Function Setting Level): Page 6-74

MV - 5 MV at Stop

The control must be set to 2-PID control.
The MV at Stop and Error Addition parameter must be ON.



Function

- This parameter sets the MV to use when the RUN/STOP status changes from RUN to STOP.



Setting

Control method	Setting range	Unit	Default
Standard	-5.0 to 105.0	%	0.0
Heating/cooling	-105.0 to 105.0		



- Related Parameters**

RUN/STOP (Operation Level): Page 6-13

MV at Stop and Error Addition (Advanced Function Setting Level): Page 6-66

MV - E MV at PV Error

The control must be set to 2-PID control.
The MV at Stop and Error Addition parameter must be ON.



Function

- This parameter sets the MV to use when an input error occurs.



Setting

Control method	Setting range	Unit	Default
Standard	-5.0 to 105.0	%	0.0
Heating/cooling	-105.0 to 105.0		



- Related Parameters**

MV at Stop and Error Addition (Advanced Function Setting Level): Page 6-66

SPRt SP Ramp Set Value

The ST parameter must be set to OFF.

SPRL SP Ramp Fall Value



Function

- These parameters set the rate of change during SP ramp operation. They set the maximum permissible change width per unit of time as the SP ramp set value and the SP ramp fall value. The SP ramp function is disabled if this parameter is set to OFF.
- For a temperature input, the decimal point positions of the SP ramp set value and SP ramp fall value depend on the currently selected sensor, and for an analog input they depend on the Decimal Point parameter.



Setting

Parameter	Setting range	Unit	Default
SP Ramp Set Value	OFF or 1 to 9,999	EU/s, EU/ min, EU/h	OFF
SP Ramp Fall Value	SAME (Same as SP ramp set value), OFF or 1 to 9,999	EU/s, EU/ min, EU/h	SAME

oL-H MV Upper Limit

The control must be set to 2-PID control.

oL-L MV Lower Limit

The ST parameter must be set to OFF.



Function

- The MV Upper Limit and MV Lower Limit parameters set the upper and lower limits of the manipulated variable. When the calculated manipulated variable exceeds the upper or lower limit value, the upper or lower limit value will be the output level.



Setting

- MV Upper Limit
The setting ranges during standard control and heating/cooling control are different.

Control method	Setting range	Unit	Default
Standard	MV lower limit + 0.1 to 105.0	%	100.0
Heating/cooling	0.0 to 105.0		

- MV Lower Limit
The setting ranges during standard control and heating/cooling control are different. The manipulated variable for the cooling control output side during heating/cooling control is expressed as a negative value.

Control method	Control method	Unit	Default
Standard	-5.0 to MV upper limit - 0.1	%	0.0
Heating/cooling	-105.0 to 0.0		-100.0



See

● Related Parameters

PID ON/OFF (Initial Setting Level): Page 6-41

ST (Initial Setting Level): Page 6-42

ORL**MV Change Rate Limit****2-PID control must be used.****The ST parameter must be set to OFF.**

Function

- The MV Change Rate Limit parameter sets the maximum allowable variation in the MV per second. If the change in the MV exceeds this setting, the MV will be changed by the MV change rate limit until the calculated value is reached. If the limit is set to 0.0, this function will be disabled.
- The MV Change Rate Limit parameter will not operate in the following situations.
 - In manual mode
 - During ST execution (Cannot be set when ST is ON.)
 - During AT execution
 - During ON/OFF control
 - While stopped (MV output during STOP)
 - During MV output when error occurs



Setting

Setting range	Unit	Default
0.0 to 100.0	%/s	0.0



See

● Related Parameters

Proportional Band (Adjustment Level): Page 6-27

SORP**Extraction of Square Root Low-cut Point**

The input type must be an analog input, and the Extraction of Square Root Enable parameter must be set to ON.



Function

- This parameter sets the extraction of square root low-cut point used for the inputs. The data after extracting the square root is shown below.
- The low-cut point is used for extracting the square root for flowrate sensors.

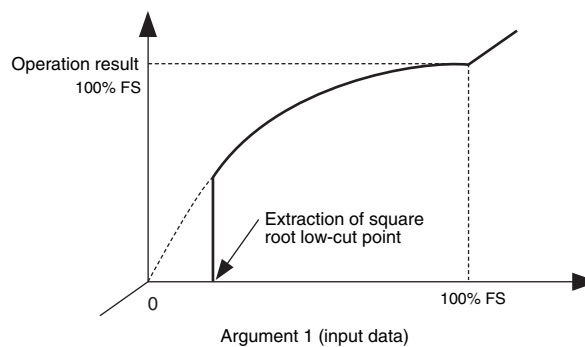

Setting

Setting range	Unit	Default
0.0 to 100.0	%	0.0



See

● Related Parameters

Extraction of Square Root Enable (Initial Setting Level): Page 6-53

W I to B \bar{O} N Work Bit 1 to 8 ON Delay
W I to B \bar{O} F Work Bit 1 to 8 OFF Delay

The work bit operation type must not be set to OFF.



- ON Delay
When the results of a work bit logic operation is ON, the work bit is turned ON after the time specified in the parameter elapses.
- OFF Delay
When the results of a work bit logic operation is OFF, the work bit is turned OFF after the time specified in the parameter elapses.



Setting range	Unit	Default
0 to 999	Seconds	0



● Related Parameters

Auxiliary Output 1 to 4 Assignment (Advanced Function Setting Level): Page 6-73

6-5 Monitor/Setting Item Level

Monitor/setting items can be displayed by means of the function key when the PF Setting parameter (Advanced Function Setting Level) is set to PFDP: Monitor/Setting Item.

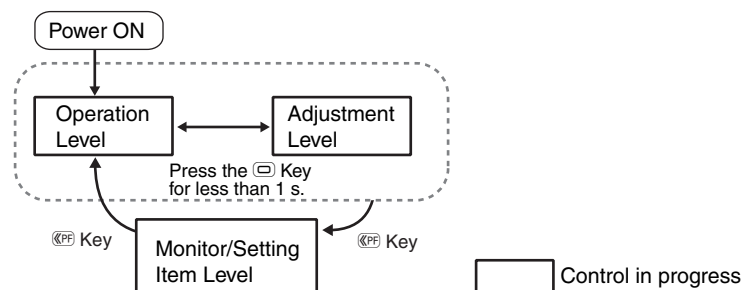

PFd 1 to 5 Monitor/Setting Item Display 1 to 5

The PF Setting parameter must be set to PFDP, and the Monitor/Setting Item 1 to 5 parameters must not be set to OFF.

- When the PF Key is set to display monitor/setting items, pressing the PF Key will display in order the contents of the Monitor/Setting Item 1 to 5 parameters. The contents of these parameters are shown in the following table. For the setting (monitor) ranges, refer to the applicable parameters.

Set value	Setting	Remarks	
		Monitor/Setting	Display
0	Disabled	---	---
1	PV/SP/Multi-SP	Can be set. (SP) ^{*1}	---
2	PV/SP/MV	Can be set. (SP) ^{*1}	---
3	PV/SP /Soak time remain	Can be set. (SP) ^{*1}	---
4	Proportional band (P)	Can be set.	<i>P</i>
5	Integral time (I)	Can be set.	<i>I</i>
6	Derivative time (D)	Can be set.	<i>d</i>
7	Alarm value 1	Can be set.	<i>AL - 1</i>
8	Alarm value upper limit 1	Can be set.	<i>AL 1H</i>
9	Alarm value lower limit 1	Can be set.	<i>AL 1L</i>
10	Alarm value 2	Can be set.	<i>AL - 2</i>
11	Alarm value upper limit 2	Can be set.	<i>AL 2H</i>
12	Alarm value lower limit 2	Can be set.	<i>AL 2L</i>
13	Alarm value 3	Can be set.	<i>AL - 3</i>
14	Alarm value upper limit 3	Can be set.	<i>AL 3H</i>
15	Alarm value lower limit 3	Can be set.	<i>AL 3L</i>
16	Alarm value 4	Can be set.	<i>AL - 4</i>
17	Alarm value upper limit 4	Can be set.	<i>AL 4H</i>
18	Alarm value lower limit 4	Can be set.	<i>AL 4L</i>
19	PV/SP/Internal SP	Can be set. (SP) ^{*1}	---
20	PV/SP/Alarm Value 1 ^{*2}	Can be set. (SP) ^{*1}	---
21	Proportional Band (Cooling)	Can be set.	<i>[- P</i>
22	Integral Time (Cooling)	Can be set.	<i>[- I</i>
23	Derivative Time (Cooling)	Can be set.	<i>[- d</i>

*1 With the E5CC, only the PV and SP can be displayed.

*2 The Alarm Value 1 parameter is displayed even if the Alarm 1 Type parameter is set for no alarm. However, any value that is set is not valid.

6-6 Manual Control Level

The manipulated variable can be set in manual mode while the PV/MV parameter is displayed. If the Manual Output Method parameter is set to HOLD when control moves from automatic mode to manual mode, the final MV from automatic mode will be used as the initial manual MV. If Manual Output Method parameter is set to INT, the setting of the Manual MV Initial Value parameter will be used as the initial manual MV. In manual mode, the change value will be saved immediately and reflected in the actual MV.

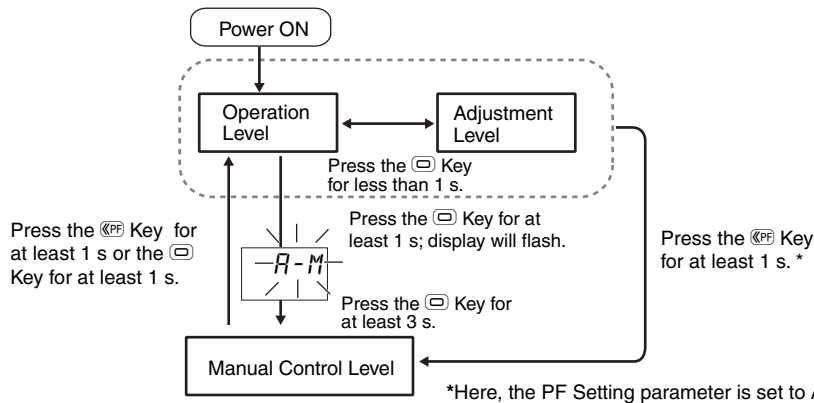

To move from the Operation Level to the Manual Control Level, press the Key for at least three seconds with the Auto/Manual Switch parameter displayed. In addition, this operation can be performed using the PF Key by setting the PF Setting parameter (Advanced Function Setting Level) to A-M (Auto/Manual). For details on the setting method, refer to *4-13 Customizing the PV/SP Display*. This setting cannot be made during ON/OFF operation.

- The MANU indicator will light during manual control.
- It is not possible to move to any displays except for the PV/MV parameter during manual operation.
- To return to the Operation Level, press the Key or the PF Key in the Manual Control Level for at least one second.

PV/MV (Manual MV)



- The manual control level display appears as shown below.

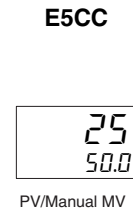
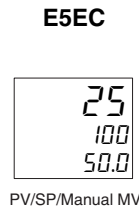

	Monitor range	Unit
Process value	Temperature: According to indication range for each sensor. Analog: Scaling lower limit -5% FS to Scaling upper limit +5% FS (Refer to A-7 Sensor Input Setting Range, Indication Range, Control Range.)	EU
Set point	SP lower limit to SP upper limit	EU

	Setting range		Unit
MV (Manual MV)	Standard control	-5.0 to 105.0*	%
	Heating/cooling control	-105.0 to 105.0*	

- * When the Manual MV Limit Enable parameter is set to ON, the setting range will be the MV lower limit to the MV upper limit.



- Related Parameters**

Standard or Heating/Cooling (Initial Setting Level): Page 6-42

6-7 Initial Setting Level

This level is used to set up the basic Digital Controller specifications. In this level, you can set the Input Type parameter to set the sensor input to be connected, limit the setting range of set points, set the alarm modes, and perform other operations.

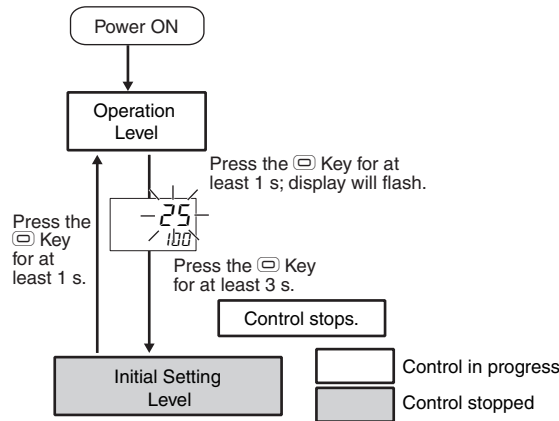

To move from the Operation Level to the Initial Setting Level, press the \square Key for at least three seconds with any parameter displayed except for the Auto/Manual Switch parameter.

- The Initial Setting Level is not displayed when the Initial Setting/Communications Protect parameter is set to 2. It can be used when the Initial Setting/Communications Protect parameter is set to 0 or 1.
- If the Input Type parameter is set for an analog input, the following parameters will be set: Scaling upper limit, Scaling lower limit, and Decimal point.

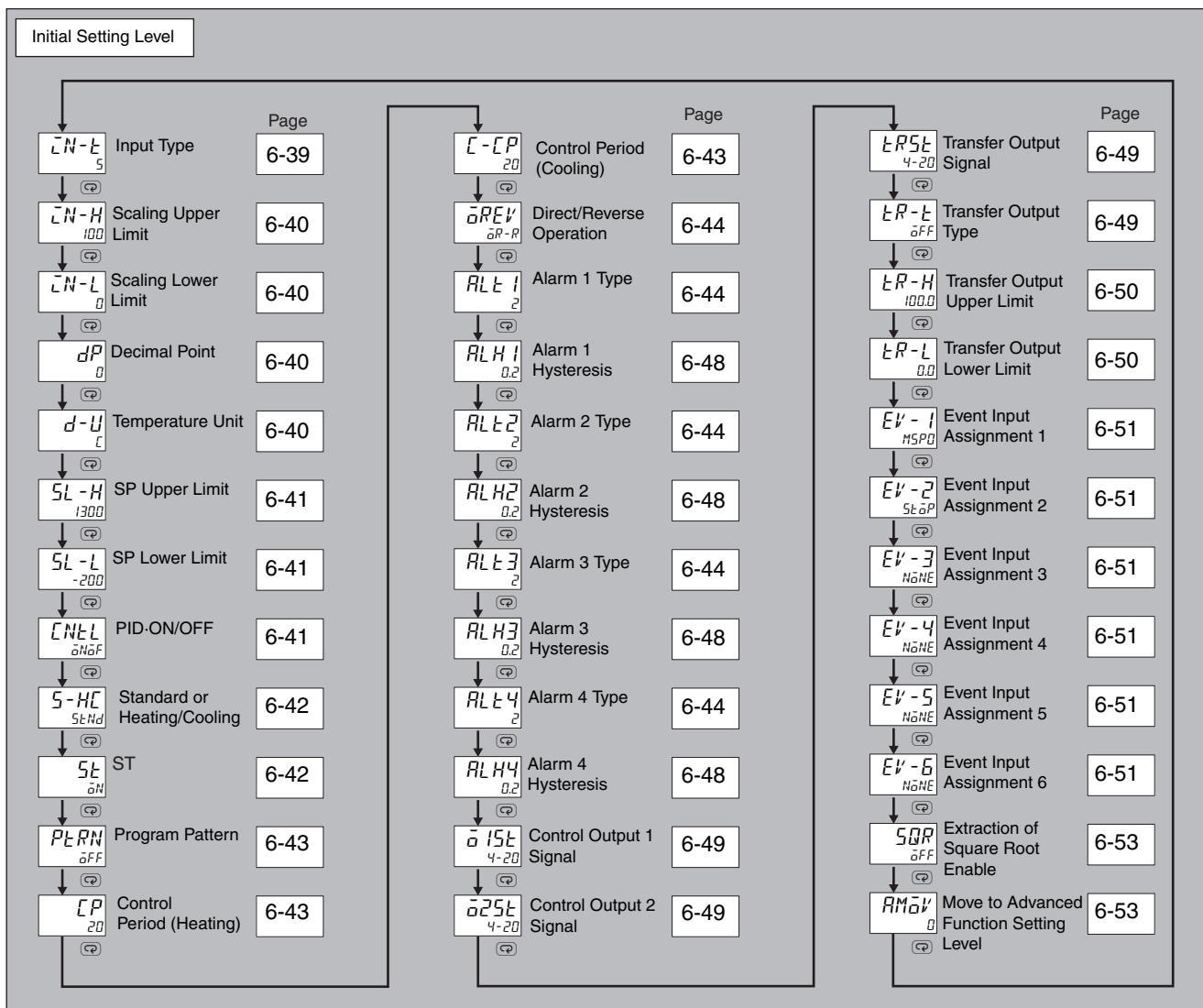

LN-t Input Type



Function

- This parameter sets the type of sensor.
- When this parameter is changed, the set point limiter is changed to the defaults. If the limiter must be specified, set the SP Upper Limit and SP Lower Limit parameters (Initial Setting Level) again.
- Set one of the set values from the following table. The default is 5.
- If a resistance thermometer is mistakenly connected while a setting for other than a resistance thermometer is in effect, *S.ERR* will be displayed. To clear the *S.ERR* display, check the wiring and then cycle the power.



Setting

Input type	Sensor specification	Set value	Temperature range in °C	Temperature range in °F
Resistance thermometer	Pt100	0	-200 to 850	-300 to 1500
		1	-199.9 to 500.0	-199.9 to 900.0
		2	0.0 to 100.0	0.0 to 210.0
	JPt100	3	-199.9 to 500.0	-199.9 to 900.0
		4	0.0 to 100.0	0.0 to 210.0
Thermocouple	K	5	-200 to 1300	-300 to 2300
		6	-20.0 to 500.0	0.0 to 900.0
	J	7	-100 to 850	-100 to 1500
		8	-20.0 to 400.0	0.0 to 750.0
	T	9	-200 to 400	-300 to 700
		10	-199.9 to 400.0	-199.9 to 700.0
	E	11	-200 to 600	-300 to 1100
	L	12	-100 to 850	-100 to 1500
		13	-200 to 400	-300 to 700
	U	14	-199.9 to 400.0	-199.9 to 700.0
		15	-200 to 1300	-300 to 2300
	R	16	0 to 1700	0 to 3000
	S	17	0 to 1700	0 to 3000
B	18	100 to 1800	300 to 3200	
W	19	0 to 2300	0 to 3200	
PLII	20	0 to 1300	0 to 2300	
Infrared Temperature Sensor ES1B	10 to 70°C	21	0 to 90	0 to 190
	60 to 120°C	22	0 to 120	0 to 240
	115 to 165°C	23	0 to 165	0 to 320
	140 to 260°C	24	0 to 260	0 to 500
Current input	4 to 20 mA	25	One of the following ranges according to the scaling:	
	0 to 20 mA	26		
Voltage input	1 to 5 V	27	-1999 to 9999	
	0 to 5 V	28	-199.9 to 999.9	
	0 to 10V	29	-19.99 to 99.99 -1.999 to 9.999	



See

● Related Parameters

- Temperature Unit (Initial Setting Level): Page 6-40
 Set Point Upper Limit (Initial Setting Level): Page 6-41
 Set Point Lower Limit (Initial Setting Level): Page 6-41

$\bar{L}N-H$ **Scaling Upper Limit**

$\bar{L}N-L$ **Scaling Lower limit**

The input type must be set for an analog input.

dP **Decimal Point**



Function

- The Decimal Point parameter specifies the decimal point position of parameters (set point, etc.) whose unit is EU.



Setting

- Scaling Upper Limit, Scaling Lower Limit

Parameter name	Setting range	Default
Scaling Upper Limit	Scaling lower limit + 1 to 9999	100
Scaling Lower Limit	-1999 to scaling upper limit - 1	0

- Decimal Point

Parameter name	Setting range	Default
Decimal Point	0 to 3	0

Set value	Settings	Example
0	0 digits past decimal point	1234
1	1 digits past decimal point	123.4
2	2 digits past decimal point	12.34
3	3 digits past decimal point	1.234



● Related Parameters

Input Type (Initial Setting Level): Page 6-39

$d-U$ **Temperature Unit**

The input type must be set for a temperature input.



Function

- Set the temperature input unit to either °C or °F.



Setting

Setting range	Default
E: °C, F: °F	E



● Related Parameters

Input Type (Initial Setting Level): Page 6-39

SL-H SP Upper Limit**SL-L** SP Lower Limit

- These parameters set the upper and lower limits of the set points. A set point can be set within the range defined by the upper and lower limit set values in the SP Upper Limit and SP Lower Limit parameters. If these parameters are reset, any set point that is outside of the new range will be forcibly changed to either the upper limit or the lower limit.
- When the temperature input type and temperature unit have been changed, the set point upper limit and set point lower limit are forcibly changed to the upper and lower limits of the sensor.
- For a temperature input, the decimal point position depends on the currently selected sensor, and for an analog input it depends on the Decimal Point parameter setting.



Parameter name		Setting range	Unit	Default
Set Point Upper Limit	Temperature input	SP lower limit + 1 to Input setting range upper limit	EU	1300
	Analog input	SP lower limit + 1 to scaling upper limit	EU	100
Set Point Lower Limit	Temperature input	Input setting range lower limit to SP upper limit - 1	EU	-200
	Analog input	Scaling lower limit to SP upper limit - 1	EU	0



● Related Parameters

- Input Type (Initial Setting Level): Page 6-39
- Temperature Unit (Initial Setting Level): Page 6-40

ENL PID ON/OFF

- This parameter selects 2-PID control or ON/OFF control.
- The auto-tuning and self-tuning functions can be used in 2-PID control.



Setting range	Default
P_{Ld} : 2-PID, $\bar{a}N\bar{o}F$: ON/OFF	$\bar{a}N\bar{o}F$



● Related Parameters

- AT Execute/Cancel (Adjustment Level): Page 6-19
- Manual Reset Value (Adjustment Level): Page 6-29
- Hysteresis (Heating) (Adjustment Level): Page 6-29
- Hysteresis (Cooling) (Adjustment Level): Page 6-29
- ST Stable Range (Advanced Function Setting Level): Page 6-60

S-HC Standard or Heating/Cooling



Function

- This parameter selects standard control or heating/cooling control.
- If heating/cooling control is selected for the E5CC when there is only one control output, the auxiliary output 2 terminal (SUB2) is assigned as the control output for cooling.
- If heating/cooling control is selected for the E5EC when there is only one control output, the auxiliary output 4 terminal (SUB4) is assigned as the control output for cooling.

Note: If standard control is selected, set the Control Output 1 Assignment to \bar{a} (control output (heating)) for either direct (cooling) or reverse (heating) operation.



Setting

Setting range	Default
$\bar{S}tNd$: Standard, $H-C$: Heating/cooling	$\bar{S}tNd$



See

● Related Parameters

MV Monitor (Heating) (Operation Level): Page 6-16

MV Monitor (Cooling) (Operation Level): Page 6-16

Dead Band (Adjustment Level): Page 6-28

Hysteresis (Heating) (Adjustment Level): Page 6-29

Hysteresis (Cooling) (Adjustment Level): Page 6-29

Control Period (Heating) (Initial Setting Level): Page 6-43

Control Period (Cooling) (Initial Setting Level): Page 6-43

Control Output 1 and 2 Assignment (Advanced Function Setting Level): Page 6-72

Auxiliary Output 1 to 4 Assignment (Advanced Function Setting Level): Page 6-73

St

ST (self-tuning)

The control must be set to a temperature input, standard control, and 2-PID control.



Function

- The ST (self-tuning) function executes tuning from the start of program execution to calculate PID constants matched to the control target. When the ST function is in operation, be sure to turn ON the power supply of the load connected to the control output simultaneously with or before starting E5CC/E5EC operation.
- Auto-tuning can be started during self-tuning.



Setting

Setting range	Default
$\bar{a}FF$: ST function OFF, $\bar{a}N$: ST function ON	$\bar{a}N$



See

● Related Parameters

Input Type (Initial Setting Level): Page 6-39

PID ON/OFF (Initial Setting Level): Page 6-41

ST Stable Range (Advanced Function Setting Level): Page 6-60

PERN Program Pattern

This parameter sets the type of control when using the simple program function.



Function

- If the program pattern is set to \bar{OFF} , the simple program will not operate.
- If the program pattern is set to $St\bar{OP}$, the RUN/STOP status will change to STOP after the soak time has expired. If the program pattern is set to \bar{CONT} , control will continue in RUN status after the soak time has expired.



Setting

	Setting range	Default
\bar{OFF}	Simple program function turned OFF	\bar{OFF}
$St\bar{OP}$	Go to STOP mode at end of program.	
\bar{CONT}	Continue in RUN mode at end of program.	



See

● Related Parameters

- Program Start (Operation Level): Page 6-12
- Soak Time Remain (Operation Level): Page 6-13
- RUN/STOP (Operation Level) : Page 6-13
- Soak Time (Adjustment Level): Page 6-30
- Wait Band (Adjustment Level): Page 6-30
- Soak Time Unit (Advanced Function Setting Level): Page 6-74

CP
 $\bar{C}-CP$

Control Period (Heating)
Control Period (Cooling)

The cooling control output and heating control output must be assigned to relay or voltage outputs (for driving SSR).

The control must be set to 2-PID control.
For the Control Period (Cooling) parameter, the control must be set to heating/cooling control.



Function

- These parameters set the output periods. Set the control periods taking the control characteristics and the electrical durability of the relay into consideration.
- For standard control, use the Control Period (Heating) parameter. The Control Period (Cooling) parameter cannot be used.
- When the heating control output is a current output, the Control Period (Heating) parameter cannot be used.
- For heating/cooling control, the control period can be set independently for heating and cooling. The Control Period (Heating) parameter is used for the heating control output, and the Control Period (Cooling) parameter is used for the cooling control output.



Setting

Parameter name	Setting range	Unit	Default
Control Period (Heating)	0.1, 0.2, 0.5, 1 to 99	Seconds	20 for relay output
			2 for voltage output (for driving SSR)
Control Period (Cooling)	0.1, 0.2, 0.5, 1 to 99	Seconds	20 for relay output
			2 for voltage output (for driving SSR)



See

● Related Parameters

- PID ON/OFF (Initial Setting Level): Page 6-41

REV Direct/Reverse Operation



- "Direct operation" refers to control where the manipulated variable is increased when the process value increases. Alternatively, "reverse operation" refers to control where the manipulated variable is increased when the process value decreases.

Setting range	Default
$\bar{a}R-R$: Reverse operation, $\bar{a}R-d$: Direct operation	$\bar{a}R-R$



- AL1** Alarm 1 Type Alarm 1 must be assigned.
- AL2** Alarm 2 Type Alarm 2 must be assigned.
- AL3** Alarm 3 Type Alarm 3 must be assigned.
- AL4** Alarm 4 Type Alarm 4 must be assigned.

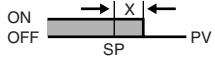
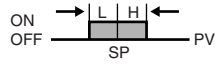
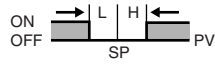
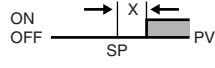
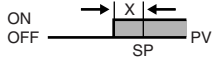
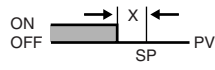
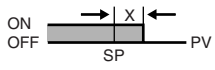
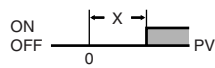
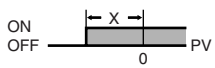
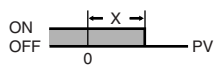
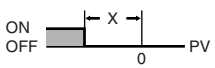
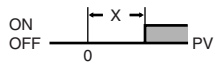
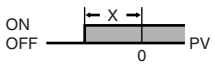
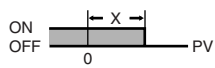
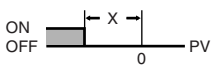
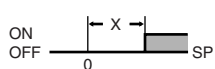
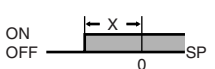
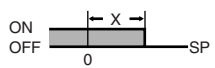
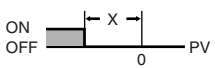

- Select one of the following eight alarm types for the alarm 1 type: Deviation, deviation range, absolute value, LBA, PV change rate, SP, MV, or RSP alarm.
- Select one of the following seven alarm types for the alarm 2 type, alarm 3 type, and alarm 4 type: Deviation, deviation range, absolute value, PV change rate, SP, MV, or RSP alarm. An LBA (loop burnout alarm) cannot be set.

Set value	Alarm type	Alarm output operation		Description of function
		When alarm value X is positive	When alarm value X is negative	
0	Alarm function OFF	Output OFF		No alarm
1	Upper- and lower-limit ^{*1}		^{*2}	Set the upward deviation in the set point for the alarm upper limit (H) and the lower deviation in the set point for the alarm lower limit (L). The alarm is ON when the PV is outside this deviation range.
2	Upper-limit			Set the upward deviation in the set point by setting the alarm value (X). The alarm is ON when the PV is higher than the SP by the deviation or more.

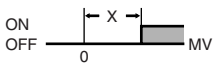
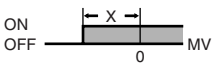
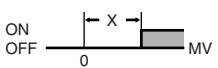
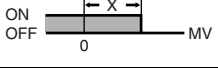
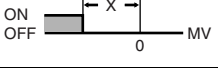
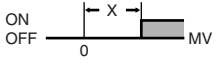
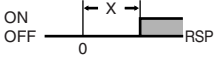
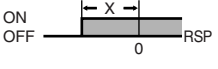
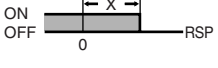
Set value	Alarm type	Alarm output operation		Description of function
		When alarm value X is positive	When alarm value X is negative	
3	Lower-limit	ON OFF 	ON OFF 	Set the downward deviation in the set point by setting the alarm value (X). The alarm is ON when the PV is lower than the SP by the deviation or more.
4	Upper- and lower-limit range*1	ON OFF 	*3	Set the upward deviation in the set point for the alarm upper limit (H) and the lower deviation in the set point for the alarm lower limit (L). The alarm is ON when the PV is inside this deviation range.
5	Upper- and lower-limit with standby sequence*1	ON OFF 	*4	A standby sequence is added to the upper- and lower-limit alarm (1). *6
6	Upper-limit with standby sequence	ON OFF 	ON OFF 	A standby sequence is added to the upper-limit alarm (2). *6
7	Lower-limit with standby sequence	ON OFF 	ON OFF 	A standby sequence is added to the lower-limit alarm (3). *6
8	Absolute-value upper-limit	ON OFF 	ON OFF 	The alarm will turn ON if the process value is larger than the alarm value (X) regardless of the set point.
9	Absolute-value lower-limit	ON OFF 	ON OFF 	The alarm will turn ON if the process value is smaller than the alarm value (X) regardless of the set point.
10	Absolute-value upper-limit with standby sequence	ON OFF 	ON OFF 	A standby sequence is added to the absolute-value upper-limit alarm (8). *6
11	Absolute-value lower-limit with standby sequence	ON OFF 	ON OFF 	A standby sequence is added to the absolute-value lower-limit alarm (9). *6
12	LBA (alarm 1 type only)			*7
13	PV change rate alarm			*8
14	SP absolute-value upper-limit alarm	ON OFF 	ON OFF 	This alarm type turns ON the alarm when the set point (SP) is higher than the alarm value (X).
15	SP absolute-value lower-limit alarm	ON OFF 	ON OFF 	This alarm type turns ON the alarm when the set point (SP) is smaller than the alarm value (X).

Set value	Alarm type	Alarm output operation		Description of function
		When alarm value X is positive	When alarm value X is negative	
16	MV absolute-value upper-limit alarm ^{*9}	Standard Control 	Standard Control 	This alarm type turns ON the alarm when the manipulated variable (MV) is higher than the alarm value (X).
		Heating/Cooling Control (Heating MV) 	Heating/Cooling Control (Heating MV) Always ON	
17	MV absolute-value lower-limit alarm ^{*9}	Standard Control 	Standard Control 	This alarm type turns ON the alarm when the manipulated variable (MV) is lower than the alarm value (X).
		Heating/Cooling Control (Cooling MV) 	Heating/Cooling Control (Cooling MV) Always ON	
18	RSP absolute-value upper-limit alarm ^{*10}			This alarm type turns ON the alarm when the remote SP (RSP) is higher than the alarm value (X).
19	RSP absolute-value lower-limit alarm ^{*10}			This alarm type turns ON the alarm when the remote SP (RSP) is lower than the alarm value (X).

*1 With set values 1, 4 and 5, the upper- and lower- limit values can be set independently for each alarm type, and are expressed as "L" and "H."

*2 Set value: 1 (Upper- and lower-limit alarm)

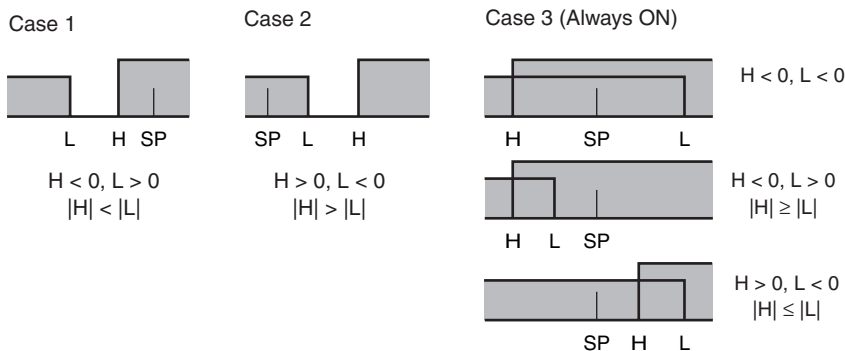

*3 Set value: 4 (Lower limit range)

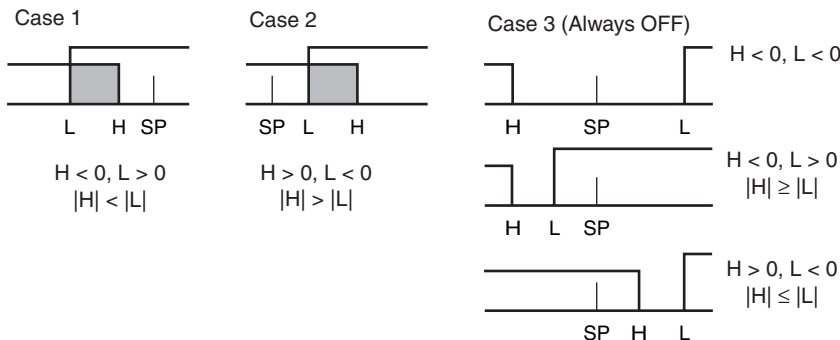

- *4 Set value: 5 (Upper- and lower-limit with standby sequence)
 - For the lower-limit alarms in cases 1 and 2 above, the alarm is normally OFF if upper- and lower-limit hysteresis overlaps.
 - In case 3, the alarm is always OFF.
 - *5 Set value: 5 (The alarm is always OFF if upper- and lower-limit alarm hysteresis with standby sequence overlaps.)
 - *6 Refer to *Standby Sequence* on page 6-57 for information on the operation of the standby sequence.
 - *7 Refer to *Loop Burnout Alarm (LBA)* on page 3-14
 - *8 Refer to *PV Change Rate Alarm* on page 3-14.
 - *9 When heating/cooling control is performed, the MV absolute-value upper-limit alarm functions only for the heating operation and the MV absolute-value lower-limit alarm functions only for the cooling operation.
 - *10 This value is displayed only when a remote SP input is used. It functions in both Local SP Mode and Remote SP Mode.
- Set the alarm type independently for each alarm in the Alarm 1 to 4 Type parameters in the initial setting level. The default is 2 (Upper-limit alarm).
 - If the Controller is equipped with HB/HS alarm detection, the Alarm 1 Type is not displayed for the default settings. To use alarm 1, set an output assignment to alarm 1. (Refer to *4-6-3 Assigned Output Functions*.)



● Related Parameters

- Alarm Value 1 to 4 (Operation Level): Page 6-14
- Alarm Upper Limit 1 to 4 (Operation Level): Page 6-15
- Alarm Lower Limit 1 to 4 (Operation Level): Page 6-15
- Alarm 1 to 4 Hysteresis (Initial Setting Level): Page 6-48
- Standby Sequence Reset (Advanced Function Setting Level): Page 6-57
- Auxiliary Output 1 to 4 Open in Alarm (Advanced Function Setting Level): Page 6-58
- Alarm 1 to 4 Latch (Advanced Function Setting Level): Page 6-63

ALH1	Alarm 1 Hysteresis	Alarm 1 must be assigned. The alarm 1 type must not be 0, 12, or 13.
ALH2	Alarm 2 Hysteresis	Alarm 2 must be assigned. The alarm 2 type must not be 0, 12, or 13.
ALH3	Alarm 3 Hysteresis	Alarm 3 must be assigned. The alarm 3 type must not be 0, 12, or 13.
ALH4	Alarm 4 Hysteresis	Alarm 4 must be assigned. The alarm 4 type must not be 0, 12, or 13.



Function

- These parameters set the hysteresis for alarms 1, 2, 3, and 4.



Setting

Alarms Other Than an MV Alarm

	Setting range	Unit	Default
Temperature input	0.1 to 999.9	°C or °F	0.2
Analog input	0.01 to 99.99	%FS	0.02

MV Alarms

Setting range	Unit	Unit
0.01 to 99.99	%	0.50



See

● Related Parameters

- Alarm Value 1 to 4 (Operation Level): Page 6-14
- Alarm Upper Limit 1 to 4 (Operation Level): Page 6-15
- Alarm Lower Limit 1 to 4 (Operation Level): Page 6-15
- Alarm 1 to 4 Type (Initial Setting Level): Page 6-44
- Standby Sequence Reset (Advanced Function Setting Level): Page 6-57
- Auxiliary Output 1 to 4 Open in Alarm (Advanced Function Setting Level): Page 6-58
- Alarm 1 to 4 Latch (Advanced Function Setting Level): Page 6-63

$\bar{0}15t$ Control Output 1 Signal Control output 1 must be a current output.

$\bar{0}25t$ Control Output 2 Signal Control output 2 must be a current output.



Function

These parameters set the output signal for linear current outputs.

- Select 4 to 20 mA or 0 to 20 mA for the signal.



Setting

Setting range	Default
4-20: 4 to 20mA	4-20
0-20: 0 to 20mA	

$tR5t$ Transfer Output Signal There must be a transfer output.



Function

This parameter sets the output signal for the transfer output.

- Select 4 to 20 mA or 1 to 5 V.



Setting

Setting range	Default
4-20: 4 to 20mA	4-20
1-5V: 1 to 5 V	

$tR-t$ Transfer Output Type There must be a transfer output.



Function

- This parameter sets the transfer output type.



Setting

Transfer output type	Default
OFF	$\bar{0}FF$
Set point	SP
Set point during SP ramp	$SP-M$
PV	PV
MV (heating)	MV
MV (cooling)	$\bar{E}-MV$



See

● Related Parameter

Transfer Output Upper Limit (Initial Setting Level): Page 6-50

Transfer Output Lower Limit (Initial Setting Level): Page 6-50

ER-H Transfer Output Upper Limit

There must be a transfer output.

ER-L Transfer Output Lower Limit

The transfer output type must not be set to OFF.



Function

- This parameter sets the upper and lower limit values of transfer outputs.



Setting

Transfer output type	Setting range		Default		Unit
			Transfer output lower limit	Transfer output upper limit	
Set point* ¹	SP lower limit to SP upper limit		SP lower limit	SP upper limit	EU
Set point during SP ramp	SP lower limit to SP upper limit				
PV	Temperature input	Input setting range lower limit to input setting range upper limit	Input setting range lower limit	Input setting range upper limit	
	Analog input	Analog scaling lower limit to analog scaling upper limit	Scaling lower limit	Scaling upper limit	
MV (heating)	Standard	-5.0 to 105.0	0.0	100.0	%
	Heating/cooling	0.0 to 105.0			
MV (cooling)* ²	0.0 to 105.0				

*1 When the SP is selected, the remote SP will be output while the Remote SP Mode is set in the SP Mode parameter.

*2 This value can be set for standard control, but the value will be disabled.



See

● Related Parameter

Transfer Output Type (Initial Setting Level): Page 6-49

<i>EV-1</i>	Event Input Assignment 1	There must be event inputs.
<i>EV-2</i>	Event Input Assignment 2	
<i>EV-3</i>	Event Input Assignment 3	
<i>EV-4</i>	Event Input Assignment 4	
<i>EV-5</i>	Event Input Assignment 5	
<i>EV-6</i>	Event Input Assignment 6	



Function

- The following functions can be assigned to event inputs 1 to 6.
 - RUN/STOP
 - Auto/Manual Switch
 - Program Start
 - Invert Direct/Reverse Operation
 - SP Mode Switch
 - 100% AT Execute/Cancel
 - 40% AT Execute/Cancel
 - Setting Change Enable/Disable
 - Communications Writing Enable/Disable
 - Alarm Latch Cancel
 - Multi-SP No. Switching Bit 0
 - Multi-SP No. Switching Bit 1
 - Multi-SP No. Switching Bit 2
- Default:

Event Input Assignment 1:	<i>MSPD</i>
Event Input Assignment 2:	<i>SEOP</i>
Event Input Assignment 3:	<i>NONE</i>
Event Input Assignment 4:	<i>NONE</i>
Event Input Assignment 5:	<i>NONE</i>
Event Input Assignment 6:	<i>NONE</i>



Setting	Function
<i>NONE</i>	None
<i>STOP</i>	RUN/STOP
<i>MANU</i>	Auto/Manual
<i>PRST</i>	Program Start* ¹
<i>dRS</i>	Invert Direct/Reverse Operation
<i>RSP</i>	SP Mode Switch* ²
<i>RE-2</i>	100% AT Execute/Cancel
<i>RE-1</i>	40% AT Execute/Cancel* ³
<i>WEPL</i>	Setting Change Enable/Disable
<i>EMWE</i>	Communications Writing Enable/Disable* ⁴
<i>LRL</i>	Alarm Latch Cancel
<i>MSP0</i>	Multi-SP No. Switching Bit 0* ⁵
<i>MSP1</i>	Multi-SP No. Switching Bit 1* ⁵
<i>MSP2</i>	Multi-SP No. Switching Bit 2* ⁵

- *1 PRST (Program Start) can be set even when the Program Pattern parameter is set to OFF, but the function will be disabled.
- *2 This function can be set only for a Controller that supports a remote SP.
- *3 This function can be set for heating/cooling control, but the function will be disabled.
- *4 This function can be set only for a Controller that supports communications. Also, if a work bit is selected as the event input data, you cannot select communications writing enable/disable.
- *5 The following table shows the relationships between the ON/OFF status of multi-SP number switching bits 0 to 2 and the set point.

Selected set point	Multi-SP No. switching bits		
	Bit 0	Bit 1	Bit 2
SP 0	OFF	OFF	OFF
SP 1	ON	OFF	OFF
SP 2	OFF	ON	OFF
SP 3	ON	ON	OFF
SP 4	OFF	OFF	ON
SP 5	ON	OFF	ON
SP 6	OFF	ON	ON
SP 7	ON	ON	ON

Note: Any bits that are not assigned to event inputs are treated as being OFF.



● Related Parameter

SP 0 to 7 (Adjustment Level): Page 6-25

SQR**Extraction of Square Root Enable** An analog input must be supported.

Function

This parameter enables and disables square root extraction.



Setting

Setting range	Default
$\bar{0}N$: Enabled, $\bar{0}FF$: Disabled	OFF



See

● **Related Parameter**

Extraction of Square Root Low-cut Point (Adjustment Level): Page 6-33

AMOV**Move to Advanced Function
Setting Level****The Initial Setting/Communications Protect
parameter must be set to 0.**

Function

- Set the Move to Advanced Function Setting Level parameter set value to "-169."
- Move to the advanced function setting level either by pressing Key or Key or by waiting or two seconds to elapse.



See

● **Related Parameter**

Initial Setting/Communication Protect (Protect Level): Page 6-4

6-8 Advanced Function Setting Level

The Advanced Function Setting Level is used for optimizing Controller performance. To move to this level, input the password ("–169") from the Initial Setting Level.

To be able to enter the password, the Initial Setting/Communications Protect parameter in the Protect Level must be set to 0.

Moving to Advanced Function Setting Level

- 1** Move from the Operation Level to the Protect Level.
- 2** Display the Initial Setting/Communications Protect parameter.

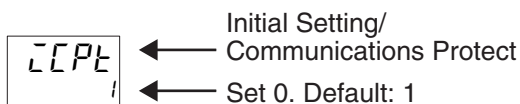

- 3** Change the set value to 0.
- 4** Move from the Protect Level to the Operation Level to the Initial Setting Level.
- 5** Display the Move to Advanced Function Setting Level parameter.

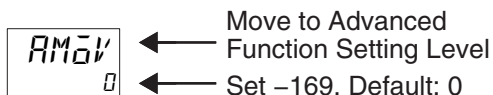

- 6** Change the set value to –169.
- 7** The Advanced Function Setting Level is displayed.

INIT (INIT) will be displayed.

- The parameters in this level can be used when the Initial Setting/Communications Protect parameter is set to 0.
- To switch between setting levels, press the Key.
- To change set values, press the and Keys.

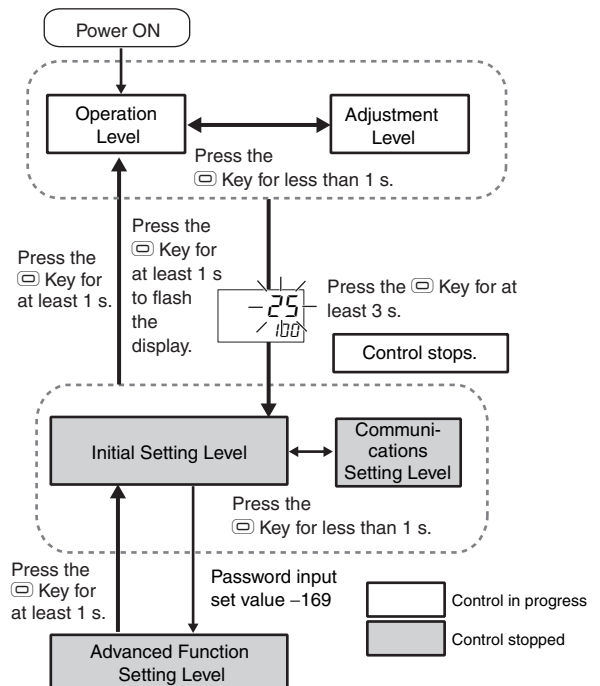

Advanced Function Setting Level			
	Page		Page
LNLT Parameter Initialization	6-56	AL1L Alarm 1 Latch	6-63
MSPU Number of Multi-SP Points	6-56	A2L1 Alarm 2 Latch	6-63
SPRU SP Ramp Time Unit	6-56	A3L1 Alarm 3 Latch	6-63
RESE Standby Sequence Reset	6-57	A4L1 Alarm 4 Latch	6-63
SbIN Auxiliary Output 1 Open in Alarm	6-58	PRL1 Move to Protect Level Time	6-64
Sb2N Auxiliary Output 2 Open in Alarm	6-58	CJCL Cold Junction Compensation Method	6-64
Sb3N Auxiliary Output 3 Open in Alarm	6-58	A1ON Alarm 1 ON Delay	6-65
Sb4N Auxiliary Output 4 Open in Alarm	6-58	A2ON Alarm 2 ON Delay	6-65
HbU HB ON/OFF	6-58	A3ON Alarm 3 ON Delay	6-65
HbL Heater Burnout Latch	6-59	A4ON Alarm 4 ON Delay	6-65
HbH Heater Burnout Hysteresis	6-59	A1OFF Alarm 1 OFF Delay	6-66
St-b ST Stable Range	6-60	A2OFF Alarm 2 OFF Delay	6-66
ALFA α	6-60	A3OFF Alarm 3 OFF Delay	6-66
LCDU Integral/Derivative Time Unit	6-60	A4OFF Alarm 4 OFF Delay	6-66
AL-G AT Calculated Gain	6-61	MVSE MV at Stop and Error Addition	6-66
AL-H AT Hysteresis	6-61	AMAd Auto/Manual Select Addition	6-67
LCMA Limit Cycle MV Amplitude	6-61	MANL Manual Output Method	6-67
LNf Input Digital Filter	6-61	MANL Manual MV Initial Value	6-67
MAV Moving Average Count	6-62	RT RT	6-68
a-dP MV Display	6-62	HSU HS Alarm Use	6-68
REt Automatic Display Return Time	6-62	HSL HS Alarm Latch	6-69
brGL Display Brightness	6-63	HSH HS Alarm Hysteresis	6-69
		LbA LBA Detection Time	6-70
		LbAL LBA Level	6-70
		LbAb LBA Band	6-71
		oUt1 Control Output 1 Assignment	6-72
		oUt2 Control Output 2 Assignment	6-72
		SUb1 Auxiliary Output 1 Assignment	6-73
		SUb2 Auxiliary Output 2 Assignment	6-73
		SUb3 Auxiliary Output 3 Assignment	6-73
		SUb4 Auxiliary Output 4 Assignment	6-73
		ALMA Integrated Alarm Assignment	6-74
		t-U Soak Time Unit	6-74
		ALSP Alarm SP Selection	6-75
		RS-t Remote SP Input	6-75
		RSPU Remote SP Enable	6-75
		RSPH Remote SP Upper limit	6-76
		RSPL Remote SP Lower limit	6-76
		SPER SP Tracking	6-77
		MANL Manual MV Limit Enable	6-77
		PVrP PV Rate of Change Calculation Period	6-78
		HCLM Heating/Cooling Tuning Method	6-78
		oMPW Minimum Output ON/OFF Band	6-79
		PF PF Setting	6-79
		PFd1 Monitor/Setting Item 1	6-80
		PFd2 Monitor/Setting Item 2	6-80
		PFd3 Monitor/Setting Item 3	6-80
		PFd4 Monitor/Setting Item 4	6-80
		PFd5 Monitor/Setting Item 5	6-80
		SPd1 PV/SP No. 1 Display Selection	6-81
		SPd2 PV/SP No. 2 Display Selection	6-81
		oDSL MV Display Selection	6-81
		PVdP PV Decimal Point Display	6-82
		PVSt PV Status Display Function	6-82
		SVSt SV Status Display Function	6-83
		dREF Display Refresh Period	6-83
		CMoV Move to Calibration Level	6-83

INCE Parameter Initialization



- This parameter returns all parameter settings to their defaults.
- After the initialization, the set value automatically turns OFF.



Setting range	Default
OFF: Initialization is not executed.	OFF
FACT: Initializes to the factory settings described in the manual.	

MSPU Number of Multi-SP Points

The Controller must not have event inputs or the Event Input Assignment 1 to Event Input Assignment 6 parameters must not be set to “Multi-SP No. switching bit 0” to “Multi-SP No. switching bit 2.”



This parameter sets the number of Multi-SP points that will be used with key operations (none or 2 to 8).



Setting range	Default
OFF, 2 to 8	OFF

SPRU SP Ramp Time Unit

The ST parameter must be set to OFF.



- This parameter sets the time unit for the rate of change during SP ramp operation.



Setting range	Default
S: EU/s, M: EU/min, H: EU/h	M



● Related Parameters

- Ramp SP Monitor (Operation Level): 6-10
- SP Ramp Set Value (Adjustment Level): Page 6-32
- SP Ramp Fall Value (Adjustment Level): Page 6-32

RESET**Standby Sequence Reset****Alarm 1 to 4 type must be 5, 6, 7, 10, or 11.**

Function

- This parameter selects the conditions for enabling reset after the standby sequence of the alarm has been canceled.
- Output is turned OFF when switching to the Initial Setting Level, Communications Setting Level, Advanced Function Setting Level, or Calibration Level.
- Condition A
Control started (including when the power supply is turned ON), and an alarm value (alarm value upper/lower limit), the process value input shift, the process value slope coefficient, or the SP changed.
- Condition B
Power ON
- The following example shows the reset action when the alarm type is lower-limit alarm with standby sequence.

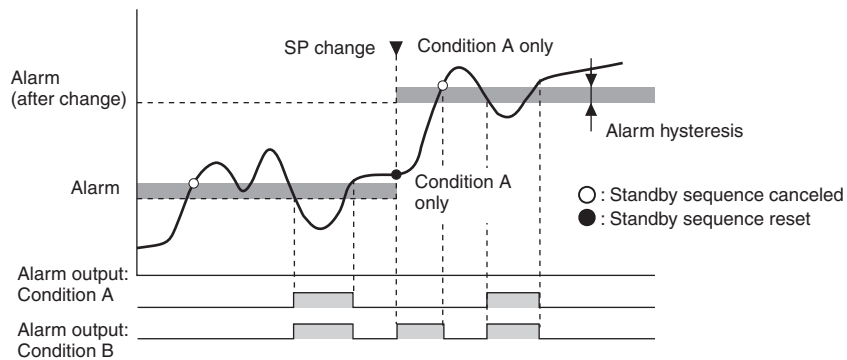

Setting

Setting range	Default
\bar{R} : Condition A, b : Condition B	\bar{R}



See

- **Related Parameters**

Alarm 1 to 4 Type (Initial Setting Level): Page 6-44

Alarm 1 to 4 Latch (Advanced Function Setting Level): Page 6-63

Sb IN Auxiliary Output 1 Open in Alarm Auxiliary output 1 must be assigned.

Sb2N Auxiliary Output 2 Open in Alarm Auxiliary output 2 must be assigned.

Sb3N Auxiliary Output 3 Open in Alarm Auxiliary output 3 must be assigned.

Sb4N Auxiliary Output 4 Open in Alarm Auxiliary output 4 must be assigned.



- This parameter sets the output status of auxiliary outputs 1 to 4.
- When Close in Alarm is set, the status of the auxiliary output function is output unchanged. When Open in Alarm is set, the status of the auxiliary output function is reversed before being output. The following table shows the relationship between the auxiliary output function, auxiliary output, and operation displays (SUB1 to SUB4).



	Auxiliary output function	Auxiliary output	Operation display (SUB1 to SUB4)
Close in Alarm	ON	ON	Lit
	OFF	OFF	Not lit
Open in Alarm	ON	OFF	Lit
	OFF	ON	Not lit

Setting range	Default
$N-\bar{a}$: Close in alarm, $N-\bar{L}$: Open in alarm	$N-\bar{a}$



● Related Parameters

Auxiliary Output 1 to 4 Assignment (Advanced Function Setting Level): Page 6-73

HbU HB ON/OFF HB and HS alarms must be supported.



- Set to use the heater burnout alarm.



Setting range	Default
$\bar{a}N$: Enabled, $\bar{a}FF$: Disabled	$\bar{a}N$

HbL**Heater Burnout Latch**

**HB and HS alarms must be supported.
The HB ON/OFF parameter must be set to ON.**



- When this parameter is set to ON, the heater burnout alarm is held until either of the following conditions is satisfied.
 - a Heater burnout detection is set to 0.0 A.
 - b The power is cycled.
 - c The latch is cancelled by the PF Key.
(PF Setting = LAT: Alarm Latch Cancel)
 - d The latch is cancelled by an event input.
(Event Input Assignment 1 to Event Input Assignment 6 = LAT: Alarm Latch Cancel)
- Output is turned OFF when switching to the Initial Setting Level.



Setting range	Default
$\bar{0}N$: Enabled, $\bar{0}FF$: Disabled	$\bar{0}FF$



● Related Parameters

- Heater Burnout Detection 1 (Adjustment Level): Page 6-21
- Heater Burnout Detection 2 (Adjustment Level): Page 6-22
- Event Input Assignment 1 to 6 (Initial Setting Level): Page 6-51
- HB ON/OFF (Advanced Function Setting Level): Page 6-58
- PF Setting (Advanced Function Setting Level): Page 6-79

HbH**Heater Burnout Hysteresis**

**The HB ON/OFF parameter must be set to ON. The
Heater Burnout Latch parameter must be set to
OFF.
HB and HS alarms must be supported.**



- This parameter sets hysteresis for heater burnout detection.



Setting range	Unit	Default
0.1 to 50.0	A	0.1



● Related Parameters

- HB ON/OFF (Advanced Function Setting Level): Page 6-58

St-b ST Stable Range

Temperature input, standard control, 2-PID control must be set.
The ST parameter must be set to ON.



- The setting of this parameter determines when ST operates. This parameter cannot be used when ST is set to OFF.



Setting range	Unit	Default
0.1 to 999.9	°C or °F	15.0



- Related Parameters**

- Input Type (Initial Setting Level): Page 6-39
- PID ON/OFF (Initial Setting Level): Page 6-41
- ST (Initial Setting Level): Page 6-42

ALFA α

2-PID control must be set.
The ST parameter must be set to OFF.



- Normally, use the default for this parameter.
- This parameter sets the 2-PID control a constant.



Setting range	Default
0.00 to 1.00	0.65



- Related Parameters**

- PID ON/OFF (Initial Setting Level): Page 6-41
- ST (Initial Setting Level): Page 6-42

t_{CDU} Integral/Derivative Time Unit

Control must be set to 2-PID control.



This parameter sets the time unit for the Integral Time, Integral Time (Cooling), Derivative Time, and Derivative Time (Cooling) parameters.



Setting range	Unit	Default
1 to 0.1	Seconds	1

Note: The Integral/Derivative Time Unit parameter changes to 0.1 when the RT (robust tuning) parameter is changed from OFF to ON.



- Related Parameters**

- Integral Time (Adjustment Level): Page 6-27
- Derivative Time (Adjustment Level): Page 6-27
- Integral Time (Cooling) (Adjustment Level): Page 6-28
- Derivative Time (Cooling) (Adjustment Level): Page 6-28

AT-G AT Calculated Gain**AT-H** AT Hysteresis

Control must be set to 2-PID control.

LCMA Limit Cycle MV Amplitude

Function

- Normally use the default values for these parameters.
- The AT Calculated Gain parameter sets the gain for when PID values are calculated using AT. When emphasizing response, decrease the set value. When emphasizing stability, increase the set value.
- The AT Hysteresis parameter sets the hysteresis for limit cycle operation during autotuning when switching ON and OFF.
- The Limit Cycle MV Amplitude parameter sets the MV amplitude for limit cycle operation during autotuning.



Setting

Parameter name	Setting range	Unit	Default
AT Calculated Gain	0.1 to 10.0	---	0.8
AT Hysteresis	Temperature input: 0.1 to 999.9	°C or °F	0.8*
	Analog input: 0.01 to 9.99	%FS	0.20
Limit Cycle MV Amplitude	5.0 to 50.0	%	20.0

* When the temperature unit is °F, the default is 1.4.



See

● Related Parameters

AT Execute/Cancel (Adjustment Level): Page 6-19

INF Input Digital Filter

Function

- This parameter sets the time constant for the input digital filter. The following diagram shows the effect on data after passing through the digital filter:

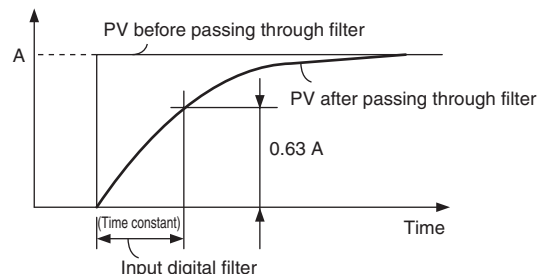

Setting

Setting range	Unit	Default
0.0 to 999.9	Seconds	0.0

MAV Moving Average Count



- This parameter sets the number of inputs to include in the moving average. The data after moving average processing is illustrated in the following figure.

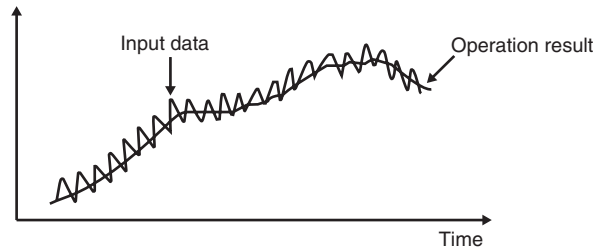

- Use a moving average to suppress rapid changes in the input.



Setting range	Unit	Default
OFF, 2, 4, 8, 16, 32	Times	OFF

$\bar{a}-dP$ MV Display



- This parameter is used to display the manipulated variable (MV). The manipulated variable is displayed when the MV Monitor (Heating) and MV Monitor (Cooling) parameters are set to ON, and not displayed when these parameters are set to OFF.



Setting range	Default
$\bar{a}N$: Displayed, $\bar{a}FF$: Not displayed	$\bar{a}FF$



● Related Parameters

- MV Monitor (Heating) (Operation Level): Page 6-16
- MV Monitor (Cooling) (Operation Level): Page 6-16

RET Automatic Display Return Time



- In the Operation Level, Adjustment Level, or Monitor/Setting Item Level, the display automatically returns to the PV/SP if there are no key operations for the time set for this parameter.
- The automatic display return time is disabled when the parameter is set to OFF. (In that case, the display will not be automatically switched.)



Setting range	Unit	Default
OFF, 1 to 99	Seconds	$\bar{a}FF$

bRGt Display Brightness

Function

This parameter sets the display brightness to one of three levels. Adjust the level if the display is too bright.



Setting

Setting range	Default
1 (dark) to 3 (bright)	3

A1Lt	Alarm 1 Latch	Alarm 1 must be assigned, and the alarm 1 type must not be 0.
A2Lt	Alarm 2 Latch	Alarm 2 must be assigned, and the alarm 2 type must not be 0 or 12.
A3Lt	Alarm 3 Latch	Alarm 3 must be assigned, and the alarm 3 type must not be 0 or 12.
A4Lt	Alarm 4 Latch	Alarm 4 must be assigned, and the alarm 4 type must not be 0 or 12.



Function

- When this parameter is set to ON, the alarm function is held until one of the following conditions is satisfied.
 - The power is cycled.
 - The latch is cancelled by the PF Key.
(PF Setting = LAT: Alarm Latch Cancel)
 - The latch is cancelled by an event input.
(Event Input Assignment 1 to Event Input Assignment 6 = LAT: Alarm Latch Cancel)
- The output is turned OFF when switching to the Initial Setting Level, Communications Setting Level, Advanced Function Setting Level, or Calibration Level.
- If an auxiliary output is set to close in alarm, the output is kept closed. If it is set to open in alarm, it is kept open.



Setting

Setting range	Default
$\bar{a}N$: Enabled, $\bar{a}FF$: Disabled	$\bar{a}FF$



See

● Related Parameters

- Alarm Value 1 to 4 (Operation Level): Page 6-14
- Alarm Value Upper Limit 1 to 4 (Operation Level): Page 6-15
- Alarm Value Lower Limit 1 to 4 (Operation Level): Page 6-15
- Alarm 1 to 4 Type (Initial Setting Level): Page 6-44
- Standby Sequence Reset (Advanced Function Setting Level): Page 6-57
- Event Input Assignment 1 to 6 (Initial Setting Level): Page 6-51
- Auxiliary Output 1 to 4 Open in Alarm (Initial Setting Level): Page 6-58
- Alarm 1 to 4 Hysteresis (Initial Setting Level): Page 6-48
- HB ON/OFF (Advanced Function Setting Level): Page 6-58
- PF Setting (Advanced Function Setting Level): Page 6-79

PRLt Move to Protect Level Time



- This parameter sets the key pressing time required to move to the Protect Level from the Operation Level, the Adjustment Level, or Monitor/Setting Item Level.



Setting range	Unit	Default
1 to 30	Seconds	3

CJC Cold Junction Compensation Method Input type must be thermocouple or infrared temperature sensor



- This parameter specifies whether cold junction compensation is to be performed internally by the Controller or to be performed externally when the input type setting is 5 to 24.
- The cold junction compensation external setting is enabled when the temperature difference is measured using two thermocouples or two ES1B Sensors.



Setting range	Default
$\bar{0}N$: Internally, $\bar{0}FF$: Externally	$\bar{0}N$



- **Related Parameters**
Input Type (Initial Setting Level): Page 6-39

A1_{ON}	Alarm 1 ON Delay	Alarm 1 must be assigned, and the alarm 1 type must not be 0, 12, or 13.
A2_{ON}	Alarm 2 ON Delay	Alarm 2 must be assigned, and the alarm 2 type must not be 0, 12, or 13.
A3_{ON}	Alarm 3 ON Delay	Alarm 3 must be assigned, and the alarm 3 type must not be 0, 12, or 13.
A4_{ON}	Alarm 4 ON Delay	Alarm 4 must be assigned, and the alarm 4 type must not be 0, 12, or 13.

The alarm 1, 2, 3, or 4 output is prevented from turning ON until after the delay times set in these parameters have elapsed.



Function

- Set the time for which the ON delay is to be enabled.
- To disable the ON delay, set 0.



Setting

Setting range	Unit	Default
0 to 999	Seconds	0



See

● Related Parameters

Alarm 1 to 4 Type (Initial Setting Level): Page 6-44

<i>A1ōF</i>	Alarm 1 OFF Delay	Alarm 1 must be assigned, and the alarm 1 type must not be 0, 12, or 13.
<i>A2ōF</i>	Alarm 2 OFF Delay	Alarm 2 must be assigned, and the alarm 2 type must not be 0, 12, or 13.
<i>A3ōF</i>	Alarm 3 OFF Delay	Alarm 3 must be assigned, and the alarm 3 type must not be 0, 12, or 13.
<i>A4ōF</i>	Alarm 4 OFF Delay	Alarm 4 must be assigned, and the alarm 4 type must not be 0, 12, or 13.

The alarm 1, 2, 3, or 4 output is prevented from turning OFF until after the delay times set in these parameters have elapsed.



Function

- Set the time for which the OFF delay is to be enabled.
- To disable the OFF delay, set 0.



Setting

Setting range	Unit	Default
0 to 999	Seconds	0



See

● Related Parameters

Alarm 1 to 4 Type (Initial Setting Level): Page 6-44

MVSE MV at Stop and Error Addition Control must be set to 2-PID control.



Function

- This parameter sets whether or not the MV at Stop and MV at PV Error parameters are to be displayed.



Setting

Setting range	Default
$\bar{a}N$: Displayed, $\bar{a}FF$: Not displayed	$\bar{a}FF$



See

● Related Parameters

MV at Stop (Adjustment Level): Page 6-31

MV at PV Error (Adjustment Level): Page 6-31

AMAd

Auto/Manual Select Addition

Control must be set to 2-PID control.



- This parameter sets whether the Auto/Manual Select Addition parameter is to be displayed.



Setting range	Default
$\bar{a}N$: Displayed, $\bar{a}FF$: Not displayed	$\bar{a}FF$



- **Related Parameters**

Auto/Manual Switch (Operation Level): Page 6-9

MANL

Manual Output Method

Control must be set to 2-PID control.



If this parameter is set to HOLD when control moves from automatic mode to manual mode, the final MV from automatic mode will be used as the initial manual MV. If this parameter is set to INT, the setting of the Manual MV Initial Value parameter will be used as the initial manual MV.



Setting range	Default
$H\bar{o}Ld$: HOLD, $\bar{I}N\bar{I}T$: INIT	$H\bar{o}Ld$



- **Related Parameters**

Manual MV Initial Value (Advanced Function Setting Level): 6-67

MANI

Manual MV Initial Value

Control must be set to 2-PID control.



This parameter sets the initial value of the manual MV to use after control moves from automatic mode to manual mode.



Setting range	Unit	Default
Standard control: -5.0 to 105.0	%	0.0
Heating/cooling control: -105.0 to 105.0	%	0.0

If the Manual MV Limit Enable parameter is set to ON, the setting range will be the MV lower limit to the MV upper limit.



- **Related Parameters**

Manual Output Method (Advanced Function Setting Level): Page 6-67

Manual MV Limit Enable (Advanced Function Setting Level): Page 6-77

RT **RT**

Control must be set to 2-PID control.
If the input type is set for a temperature input, either the Standard or Heating/Cooling parameter must be set to standard control or, if the Standard or Heating/Cooling parameter is set to heating/cooling control, the Heating/Cooling Tuning Method parameter must not be set to air or water cooling.

This parameter executes robust tuning (RT).



- When AT or ST is executed with RT selected, PID constants are automatically set which make it hard for control performance to degenerate even when control object characteristics are changed.
- Even when hunting occurs for PID constants when AT or ST is executed in normal mode, it is less likely to occur when AT or ST is executed in RT mode.



Setting range	Default
$\bar{0}N$: RT function ON, $\bar{0}FF$: RT function OFF	$\bar{0}FF$

Note: The Integral/Derivative Time Unit parameter changes to 0.1 when the RT (Robust Tuning) parameter is changed from OFF to ON.



● Related Parameters

- AT Execute/Cancel (Adjustment Level): Page 6-19
- Proportional Band (Adjustment Level): Page 6-27
- Integral Time (Adjustment Level): Page 6-27
- Derivative Time (Adjustment Level): Page 6-27
- Proportional Band (Cooling) (Adjustment Level): Page 6-28
- Integral Time (Cooling) (Adjustment Level): Page 6-28
- Derivative Time (Cooling) (Adjustment Level): Page 6-28
- PID ON/OFF (Initial Setting Level): Page 6-41
- ST (Initial Setting Level): Page 6-42
- Integral/Derivative Time Unit (Advanced Function Setting Level): Page 6-60

HSU**HS Alarm Use****HB and HS alarms must be supported.**

- Set this parameter to use HS alarms.



Setting range	Default
$\bar{0}N$: Enabled, $\bar{0}FF$: Disabled	$\bar{0}N$

H5L**HS Alarm Latch****HB and HS alarms must be supported.****The HS Alarm Use parameter must be set to ON.**

- When this parameter is set to ON, the HS alarm is held until any of the following conditions is satisfied.
 - a The HS alarm current is set to 50.0 A.
 - b The power is cycled.
 - c The latch is cancelled by the PF Key.
(PF Setting = LAT: Alarm Latch Cancel)
 - d The latch is cancelled by an event input.
(Event Input Assignment 1 to Event Input Assignment 6 = LAT: Alarm Latch Cancel)
- Output is turned OFF when switching to the Initial Setting Level, Communications Setting Level, Advanced Function Setting Level, or Calibration Level.



Setting range	Default
$\bar{a}N$: Enabled, $\bar{a}FF$: Disabled	$\bar{a}FF$



- **Related Parameters**

- HS Alarm Use (Advanced Function Setting Level): Page 6-68
- Event Input Assignment 1 to 6 (Initial Setting Level): Page 6-51
- HB ON/OFF (Advanced Function Setting Level): Page 6-58
- PF Setting (Advanced Function Setting Level): Page 6-79

H5H**HS Alarm Hysteresis****HB and HS alarms must be supported.****The HS Alarm Use parameter must be set to ON.****The HS Alarm Latch parameter must be set to OFF.**

- This parameter sets the hysteresis for HS alarms.



Setting range	Unit	Default
0.1 to 50.0	A	0.1



- **Related Parameters**

- HS Alarm Use (Advanced Function Setting Level): Page 6-68

LbA**LBA Detection Time****Alarm 1 must be assigned.
The alarm type must be set to 12 (LBA).**

This parameter enables or disables the LBA function and sets the detection time interval.



Function

- To disable the LBA function, set 0.



Setting

Setting range	Unit	Default
0 to 9999	Seconds	0



See

● Related Parameters

- Alarm 1 to 4 Type (Initial Setting Level): Page 6-44
- LBA Level (Advanced Function Setting Level): Page 6-70
- LBA Band (Advanced Function Setting Level): Page 6-71

LbAL**LBA Level****Alarm 1 must be assigned.
The alarm type must be set to 12 (LBA).
The LBA detection time must not be 0.**

Function

- This parameter sets the LBA level.
- If the deviation between the SP and PV exceeds the LBA level, a loop burnout is detected.



Setting

Setting range	Unit	Default	
Temperature input	0.1 to 999.9	°C or °F	8.0
Analog input	0.01 to 99.99	%FS	10.00



See

● Related Parameters

- Process Value/Set Point (Operation Level): Page 6-8
- Alarm 1 to 4 Type (Initial Setting Level): Page 6-44
- LBA Detection Time (Advanced Function Setting Level): Page 6-70
- LBA Band (Advanced Function Setting Level): Page 6-71

LbAb**LBA Band****Alarm 1 must be assigned.****The alarm type must be set to 12 (LBA).****The LBA detection time must not be 0.**

Function

- This parameter sets the LBA band.
- If a control deviation greater than the LBA band is not reduced when the LBA level is exceeded, an loop burnout is detected.



Setting

	Setting range	Unit	Default
Temperature input	0.0 to 999.9	°C or °F	3.0
Analog input	0.00 to 99.99	%FS	0.20



See

● Related Parameters

Process Value/Set Point (Operation Level): Page 6-8

Alarm 1 to 4 Type (Initial Setting Level): Page 6-44

LBA Detection Time (Advanced Function Setting Level): Page 6-70

LBA Level (Advanced Function Setting Level): Page 6-70

OUT 1 Control Output 1 Assignment

OUT 2 Control Output 2 Assignment With control output 2



Function



Setting

- These parameters set the function to assign to control outputs 1 and 2.

Setting range		Default
<i>None</i> :	Disabled	Control Output 1 Assignment: \bar{a}
\bar{a} :	Control output (heating)	Control Output 2 Assignment: <i>None</i> ^{*5}
$\bar{c}-\bar{a}$:	Control output (cooling) ^{*1}	
<i>ALM1</i> :	Alarm 1 ^{*2}	
<i>ALM2</i> :	Alarm 2 ^{*2}	
<i>ALM3</i> :	Alarm 3 ^{*2}	
<i>ALM4</i> :	Alarm 4 ^{*2}	
<i>HA</i> :	Heater alarm ^{*2}	
<i>Hb</i> :	HB alarm ^{*2}	
<i>HS</i> :	HS alarm ^{*2}	
<i>S.ERR</i> :	Input error ^{*2}	
<i>R5.ERR</i> :	RSP input error ^{*2}	
<i>P.END</i> :	Program end output ^{*2*3}	
<i>RUN</i> :	RUN output ^{*2}	
<i>ALM</i> :	Integrated Alarm ^{*2}	
<i>WR1</i> :	Work bit 1 ^{*2*4}	
<i>WR2</i> :	Work bit 2 ^{*2*4}	
<i>WR3</i> :	Work bit 3 ^{*2*4}	
<i>WR4</i> :	Work bit 4 ^{*2*4}	
<i>WR5</i> :	Work bit 5 ^{*2*4}	
<i>WR6</i> :	Work bit 6 ^{*2*4}	
<i>WR7</i> :	Work bit 7 ^{*2*4}	
<i>WR8</i> :	Work bit 8 ^{*2*4}	

- *1 If $\bar{c}-\bar{a}$ is assigned for standard control, a value equivalent to 0% is output.
- *2 Can be selected for relay and voltage outputs (for driving SSR) only.
- *3 Can be selected when the Program Pattern parameter is set to OFF, but the function will be disabled.
- *4 WR1 to WR8 are not displayed when the logic operation function is not used.
- *5 If the Standard or Heating/Cooling parameter is set to heating/cooling control, control automatically switches to $\bar{c}-\bar{a}$.

Sub 1	Auxiliary Output 1 Assignment	There must be an auxiliary output 1.
Sub 2	Auxiliary Output 2 Assignment	There must be an auxiliary output 2.
Sub 3	Auxiliary Output 3 Assignment	There must be an auxiliary output 3.
Sub 4	Auxiliary Output 4 Assignment	There must be an auxiliary output 4.

- These parameters set the function to assign to auxiliary outputs 1 to 4.

Setting range		Default
<i>NONE</i> :	Disabled	Auxiliary Output 1 Assignment: <i>RLM1</i> ^{*5}
<i>o</i> :	Control output (heating)	Auxiliary Output 2 Assignment: <i>RLM2</i> ^{*2}
<i>[-o</i> :	Control output (cooling) ^{*1}	Auxiliary Output 3 Assignment: <i>RLM3</i> ^{*2}
<i>RLM1</i> :	Alarm 1	Auxiliary Output 4 Assignment: <i>RLM4</i> ^{*2}
<i>RLM2</i> :	Alarm 2	
<i>RLM3</i> :	Alarm 3	
<i>RLM4</i> :	Alarm 4	
<i>HR</i> :	Heater alarm	
<i>Hb</i> :	HB alarm	
<i>HS</i> :	HS alarm	
<i>S.ERR</i> :	Input error	
<i>R5.ER</i> :	RSP input error	
<i>P.END</i> :	Program end output ^{*3}	
<i>RUN</i> :	RUN output	
<i>RLM</i> :	Integrated Alarm	
<i>WR1</i> :	Work bit 1 ^{*4}	
<i>WR2</i> :	Work bit 2 ^{*4}	
<i>WR3</i> :	Work bit 3 ^{*4}	
<i>WR4</i> :	Work bit 4 ^{*4}	
<i>WR5</i> :	Work bit 5 ^{*4}	
<i>WR6</i> :	Work bit 6 ^{*4}	
<i>WR7</i> :	Work bit 7 ^{*4}	
<i>WR8</i> :	Work bit 8 ^{*4}	

- *1 If *[-o* is assigned for standard control, a value equivalent to 0% will be output.
- *2 If heating/cooling control is used with an E5CC Controller that does not have control output 2, *[-o* is automatically assigned to auxiliary output 2. If heating/cooling control is used with an E5EC Controller that does not have control output 2, *[-o* is automatically assigned to auxiliary output 4 if there are four auxiliary outputs and to auxiliary output 2 if there are only 2 auxiliary outputs.
- *3 Can be selected when the Program Pattern parameter is set to OFF, but the function will be disabled.
- *4 WR1 to WR8 are not displayed when the logic operation function is not used.
- *5 If the Controller is equipped with HB/HS alarm detection, it is set by default to *HR* (Heater Alarm).

ALMA**Integrated Alarm Assignment****The integrated alarm must be assigned.**

You can use the integrated alarm to output an OR of alarm 1, alarm 2, alarm 3, alarm 4, the HB alarm, the HS alarm, the input alarm, and the RSP input alarm. Set this parameter to the sum of the codes of the status for which to output an OR.

The default is 49 (i.e., an OR of alarm 1, the HB alarm, and the HS alarm is output). The alarm 1 code is 1, the HB alarm code is 16, and the HS alarm code is 32: $1 + 16 + 32 = 49$.



Code	Status
+1	Alarm 1
+2	Alarm 2
+4	Alarm 3
+8	Alarm 4
+16	HB alarm
+32	HS alarm
+64	Input error
+128	RSP input error

Setting range	Default
0 to 255	49



- **Related Parameters**

- Alarm Value 1 to 4 (Operation Level): Page 6-14
- MV at Error (Adjustment Level): Page 6-31
- HB ON/OFF (Advanced Function Setting Level): Page 6-58
- HS Alarm Use (Advanced Function Setting Level): Page 6-68
- Remote SP Enable (Advanced Function Setting Level): Page 6-75

t-U**Soak Time Unit****The Program Pattern parameter must not be set to OFF.**

- Set the soak time unit for the simple program function.



Setting range	Default
M: Minutes, H: Hours	M



- **Related Parameters**

- Program Start (Operation Level): Page 6-12
- Soak Time Remain (Operation Level): Page 6-13
- Soak Time (Adjustment Level): Page 6-30
- Wait Band (Adjustment Level): Page 6-30
- Program Pattern (Initial Setting Level): Page 6-43

ALSP Alarm SP Selection

Alarm 1 to alarm 4 must be assigned.
 The SP Ramp Set Value parameter must not be set to OFF and the SP Ramp Fall Value parameter must not be set to SAME or OFF. The ST parameter must be set to OFF.
 The alarm type must be set to 1, 2, 3, 4, 5, 6, 7, 14, 15, 18, or 19.

This parameter sets whether the set point that triggers the alarm is the ramp SP or target SP.



Setting

Setting range	Default
SP-M: Ramp SP, SP: SP	SP-M



- **Related Parameters**

SP Ramp Set Value (Adjustment Level): Page 6-32
 SP Ramp Fall Value (Adjustment Level): Page 6-32
 ST (Self-tuning) (Initial Setting Level): Page 6-42

RS-t Remote SP Input

Function

This parameter sets the input type for the remote SP.



Setting

Setting range	Default
4-20: 4 to 20mA	4-20
0-20: 0 to 20mA	
1-5V: 1 to 5V	
0-5V: 0 to 5V	
0-10: 0 to 10V	

RSPU Remote SP Enable

The ST parameter must be set to OFF.



Function

This parameter is set to ON to enable setting SP Mode. You can set the SP Mode parameter to LSP to select a local SP or to RSP to select a remote SP. If this parameter is set to OFF, only a local SP can be used.



Setting

Setting range	Default
ON: Enabled or OFF: Disabled	OFF



- **Related Parameters**

SP Mode (Adjustment Level): Page 6-20

RSPH Remote SP Upper Limit

The ST parameter must be set to OFF.
The Remote SP Enable parameter must be set to ON.

RSP L Remote SP Lower Limit



You can scale the remote SP input for the PV input range with the values that are set for the Remote SP Upper and Lower Limit parameters.

Remote SP Input of 4 to 20 mA

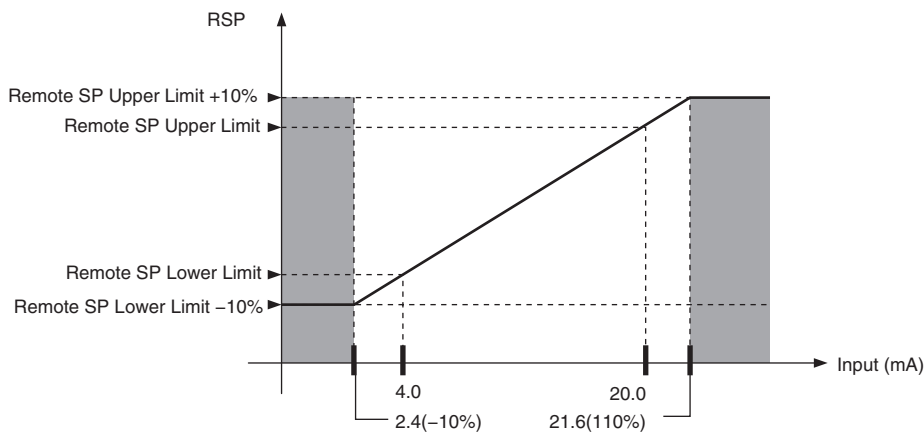

- The remote SP input can be from the remote SP lower limit -10% to the remote SP upper limit +10%. Input values outside of this range are treated as out-of-range input values (RSP input errors) and clamped to the upper or lower limit. The RSP indicator will flash in Remote SP Mode and the Remote SP Monitor will flash on the No. 2 display in any SP Mode.
- When you use the remote SP input value as the control SP, it is restricted by the set point upper limit and the set point lower limit.



Parameter	Setting range	Unit	Default
Remote SP Upper Limit	Temperature input: Input setting range lower limit to Input setting range upper limit	EU	1300
Remote SP Lower Limit	Analog input: Scaling lower limit to Scaling upper limit		-200



● **Related Parameters**

- Remote SP Input (Advanced Function Setting Level): Page 6-75
- Remote SP Enable (Advanced Function Setting Level): Page 6-75

SPLR SP Tracking

The ST parameter must be set to OFF.
The Remote SP Enable parameter must be set to ON.



Function

- This parameter sets the operation to perform when moving from Remote SP Mode to Local SP Mode.
- When this parameter is set to ON, operation continues using the remote SP as the local SP.
- When this parameter is set to OFF, the remote SP does not affect the local SP.



Setting

Setting range	Default
$\bar{a}N$: Enabled or $\bar{a}FF$: Disabled	$\bar{a}FF$



See

- **Related Parameters**

Set Point During SP Ramp (Operation Level): Page 6-10
SP Mode (Adjustment Level): Page 6-20

MANL Manual MV Limit Enable

Control must be set to 2-PID control.



Function

- This parameter sets whether the MV Upper Limit and MV Lower Limit parameters are to be enabled for manual MV in manual mode.



Setting

Setting range	Default
$\bar{a}N$: Enabled, $\bar{a}FF$: Disabled	$\bar{a}FF$



See

- **Related Parameters**

MV Upper Limit (Adjustment Level): Page 6-32
MV Lower Limit (Adjustment Level): Page 6-32

PV RP

PV Rate of Change Calculation Period

Alarms 1, 2, 3, and 4 must be assigned. The alarm type must be set to 13.



- The change width can be found for PV input values in any set period. Differences with previous values in each set period are calculated, and an alarm is output if the results exceed the alarm value.
- The PV rate of change calculation period can be set in units of 50 ms (sampling period).



Setting range	Unit	Default
1 to 999	Sampling cycle	20 (1 s)



● **Related Parameters**

Process Value/Set Point (Operation Level): Page 6-8
 Alarm 1 to 4 Type (Initial Setting Level): Page 6-44

HCCM

Heating/Cooling Tuning Method

The control must be set to heating/cooling control and 2-PID control.



This parameter sets the tuning method that is suitable for the cooling control characteristics.



Setting range	Default
0: Same as heating control	0
1: Linear	
2: Air cooling	
3: Water cooling	

- **Air Cooling/Water Cooling**
 Control that is suitable for an application that does not have linear cooling characteristics (such as plastic molding machines) is performed. The response is fast and the response characteristics are stable.
- **Linear**
 Control that is suitable for an application that has linear cooling characteristics is performed.

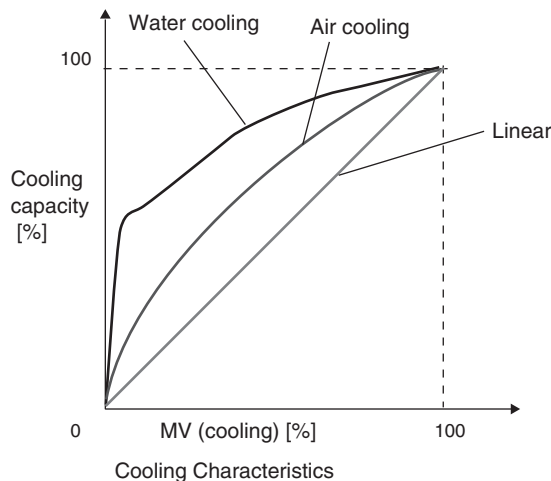

OMPW**Minimum Output ON/OFF Band****Control must be set to 2-PID control.**

Function

This parameter sets the minimum ON/OFF width of the outputs that are assigned for the heating and cooling control outputs. You can set this parameter to prevent deterioration of a relay output.



Setting

Setting range	Unit	Default
0.0 to 50.0	%	1.0

PF**PF Setting**

Function

- This parameter sets the function of the PF Key.



Setting

- The default is SHFT (Digit Shift).

Set value	Setting	Function
OFF: $\bar{O}FF$	Disabled	Does not operate as a function key.
RUN: RUN	RUN	Specifies RUN status.
STOP: $St\bar{O}P$	STOP	Specifies STOP status.
R-S: $R-S$	Reversing RUN/STOP operation	Specifies reversing RUN/STOP operation status.
AT-2: $R\bar{E}-2$	100%AT Execute/Cancel	Specifies reversing 100% AT Execute/Cancel status. ^{*1}
AT-1: $R\bar{E}-1$	40%AT Execute/Cancel	Specifies reversing 40% AT Execute/Cancel status. ^{*1}
LAT: $L\bar{R}\bar{E}$	Alarm Latch Cancel	Specifies canceling alarm latches. ^{*2}
A-M: $R-M$	Auto/Manual	Specifies reversing Auto/Manual status. ^{*3}
PFDP: $P\bar{F}dP$	Monitor/Setting Item	Specifies the monitor/setting item display. Select the monitor/setting item using the Monitor/Setting Item 1 to 5 parameters (Advanced Function Setting Level).
SHFT: $S\bar{H}F\bar{E}$	Digit Shift	Operates as a Digit Shift Key when settings are being changed.

^{*1} When AT cancel is specified, it means that AT is cancelled regardless of whether the AT currently being executed is 100% AT or 40% AT.

^{*2} Alarms 1 to 4, the HB alarm, and the HS alarm are cancelled.

^{*3} For details on auto/manual operations using the PF Key, refer to 5-12 *Performing Manual Control*.



- Related Parameters**

Monitor/Setting Item 1 to 5 (Advanced Function Setting Level): Page 6-80

PFd1 Monitor/Setting Item 1

PFd2 Monitor/Setting Item 2

PFd3 Monitor/Setting Item 3

The PF Setting parameter must be set to PFDP.

PFd4 Monitor/Setting Item 4

PFd5 Monitor/Setting Item 5



Function

- When the PF Key is set to display monitor/setting items, pressing the PF Key will display in order the contents of the Monitor/Setting Item 1 to 5 parameters. The contents of these parameters are shown in the following table. Refer to the relevant parameters for the setting/monitor ranges.

Set value	Setting	Remarks	
		Monitor/Setting	Display
0	Disabled		---
1	PV/SP/Multi-SP	Can be set. (SP) ^{*1}	---
2	PV/SP/MV	Can be set. (SP) ^{*1}	---
3	PV/SP/Soak time remain	Can be set. (SP) ^{*1}	---
4	Proportional band	Can be set.	P
5	Integral time	Can be set.	I
6	Derivative time	Can be set.	d
7	Alarm value 1	Can be set.	AL-1
8	Alarm value upper limit 1	Can be set.	AL1H
9	Alarm value lower limit 1	Can be set.	AL1L
10	Alarm value 2	Can be set.	AL-2
11	Alarm value upper limit 2	Can be set.	AL2H
12	Alarm value lower limit 2	Can be set.	AL2L
13	Alarm value 3	Can be set.	AL-3
14	Alarm value upper limit 3	Can be set.	AL3H
15	Alarm value lower limit 3	Can be set.	AL3L
16	Alarm value 4	Can be set.	AL-4
17	Alarm value upper limit 4	Can be set.	AL4H
18	Alarm value lower limit 4	Can be set.	AL4L
19	PV/SP/Internal SP	Can be set. (SP) ^{*1}	---
20	PV/SP/Alarm Value 1 ^{*2}	Can be set. (SP) ^{*1}	---
21	Proportional Band (Cooling)	Can be set.	I-P
22	Integral Time (Cooling)	Can be set.	I-I
23	Derivative Time (Cooling)	Can be set.	I-d

*1 With the E5CC, only the PV and SP can be displayed.

*2 The Alarm Value 1 parameter is displayed even if the Alarm 1 Type parameter is set for no alarm. However, any value that is set is not valid.

SPd1 PV/SP No. 1 Display Selection**SPd2** PV/SP No. 2 Display Selection

Function

These parameters set the items to display on the No. 1 display, No. 2 display, and No. 3 display. (Only the E5EC has a No. 3 display.)



Setting

Set value	No. 1 display	No. 2 display	No. 3 display (E5EC only)
0	Nothing is displayed.	Nothing is displayed.	Nothing is displayed.
1	Process value	Set point	Nothing is displayed.
2	Process value	Nothing is displayed.	Nothing is displayed.
3	Set point	SP (character display)	Nothing is displayed.
4	Process value	Set point	Manipulated value
5	Process value	Set point	Multi-SP No.
6	Process value	Set point	Soak time remain
7	Process value	Set point	Internal set point (ramp SP)
8	Process value	Set point	Alarm value 1*

* The Alarm Value 1 parameter is displayed even if the Alarm 1 Type parameter is set for no alarm. However, any value that is set is not valid.

Parameter	Setting range	Default
PV/SP No. 1 Display Selection	0 to 8	4
PV/SP No. 2 Display Selection		0

ōd5L MV Display Selection

There must be a No. 3 display (E5EC). Heating/cooling control must be selected. The PV/SP No. 1 Display Selection or PV/SP No. 2 Display Selection parameter must be set to 4, or the PF Setting parameter must be set to PFDP and one of the monitor/setting items 1 to 5 must be set to 2.



Function

- This parameter selects the MV display for PV/SP/MV during heating and cooling control. Either heating MV or cooling MV can be selected.



Setting

Setting range	Default
ō: MV (heating)	ō
┌-ō: MV (cooling)	

PV dP**PV Decimal Point Display**

The input type must be set for a temperature input.

The display below the decimal point in the PV can be hidden for temperature inputs.



- The PV decimals below the decimal point can be hidden by setting the PV Decimal Point Display parameter to OFF. When this parameter is set to ON, the display below the decimal point will appear according to the input type setting.



Setting range	Default
$\bar{o}N$: ON, $\bar{o}FF$: OFF	ON



- Related Parameters**

Input Type (Initial Setting Level): Page 6-39

PV St**PV Status Display Function**

- This parameter sets a control or alarm status that is displayed alternately in 0.5-s cycles on the No. 1 display when the PV is set to be displayed in the No. 1 display.
- PV
- PV/SP*
- PV/Manual MV
- PV/SP/Manual MV

* This includes when the PV/SP is selected for the Monitor/Setting Item parameter.



Setting range	Default
$\bar{o}FF$: No PV status display	$\bar{o}FF$
$MANU$: MANU is alternately displayed during manual control.	
$St\bar{o}P$: STOP is alternately displayed while operation is stopped.	
$ALM1$: ALM1 is alternately displayed during Alarm 1 status.	
$ALM2$: ALM2 is alternately displayed during Alarm 2 status.	
$ALM3$: ALM3 is alternately displayed during Alarm 3 status.	
$ALM4$: ALM4 is alternately displayed during Alarm 4 status.	
ALM : ALM is alternately displayed when Alarm 1, 2, 3, or 4 is set to ON.	
HA : HA is alternately displayed when an HB alarm or HS alarm is ON.	



- Related Parameters**

Process Value/Set Point (Operation Level): Page 6-8

PV/MV (Manual MV) (Manual Control Level): Page 6-37

SVSt SV Status Display Function



Function

- This parameter sets a control or alarm status that is displayed alternately in 0.5-s cycles on the No. 2 display when the PV is set to be displayed in the No. 1 display.
 - PV
 - PV/SP*
 - PV/Manual MV
 - PV/SP/Manual MV
- * This includes when the PV/SP is selected for the Monitor/Setting Item parameter.



Setting

Setting range		Default
OFF:	No SV status display	OFF
MANU:	MANU is alternately displayed during manual control.	
STOP:	STOP is alternately displayed while operation is stopped.	
ALM1:	ALM1 is alternately displayed during Alarm 1 status.	
ALM2:	ALM2 is alternately displayed during Alarm 2 status.	
ALM3:	ALM3 is alternately displayed during Alarm 3 status.	
ALM4:	ALM4 is alternately displayed during Alarm 4 status.	
ALM:	ALM is alternately displayed when Alarm 1, 2, 3, or 4 is set to ON.	
HR:	HA is alternately displayed when an HB alarm or HS alarm is ON.	



See

● Related Parameters

- Process Value/Set Point (Operation Level): Page 6-8
- PV/MV (Manual MV) (Manual Control Level): Page 6-37

d.REF Display Refresh Period



Function

- This parameter delays the display refresh period for monitor values. Only display refreshing is delayed, and the refresh period for process values used in control is not changed.
- This function is disabled by setting the parameter to OFF.



Setting

Setting range	Unit	Default
OFF, 0.25, 0.5, 1.0	Seconds	0.25

CMoV Move to Calibration Level

Initial setting/communications protect must be 0.

This parameter sets the password to move to the Calibration Level.



Function

- Set the password to move to the Calibration Level. The password is 1201.
- Move to the Calibration Level either by pressing the Key or Key or by waiting for two seconds to elapse.



See

● Related Parameter

- Initial Setting/Communications Protect (Protect Level): Page 6-4

6-9 Communications Setting Level

<i>PSEL</i>	Protocol Setting	Communications must be supported.
<i>U-Nō</i>	Communications Unit No.	
<i>bPS</i>	Communications Baud Rate	
<i>LEN</i>	Communications Data Length	CompoWay/F must be selected as the protocol.
<i>Sbċt</i>	Communications Stop Bits	CompoWay/F must be selected as the protocol.
<i>PRċY</i>	Communications Parity	
<i>SdWċt</i>	Send Data Wait Time	



Function

- Each parameter is enabled when the power is reset.
- Match the communications specifications of the E5CC/E5EC and the host computer. If multiple devices are connected, ensure that the communications specifications for all devices in the system (except the Communications unit number) are the same.



Setting

Item	Display	Set values	Settings	Default
Protocol setting	<i>PSEL</i>	<i>ċWF Mōd</i>	CompoWay/F/Modbus	<i>ċWF</i>
Communications Unit No.	<i>U-Nō</i>	0 to 99	0 to 99	<i>1</i>
Communications baud rate	<i>bPS</i>	9.6/19.2/38.4/57.6 (Kbps)	9.6/19.2/38.4/57.6 (kbps)	<i>9.6</i>
Communications data length	<i>LEN</i>	7 or 8 bits	7 or 8 bits	<i>7</i>
Stop bits	<i>Sbċt</i>	1 or 2 bits	1 or 2 bits	<i>2</i>
Communications parity	<i>PRċY</i>	<i>NōNE EVċEN ōdd</i>	None, Even, Odd	<i>EVċEN</i>
Send data wait time	<i>SdWċt</i>	0 to 99	0 to 99 (ms)	<i>20</i>



See

● Related Parameter

Communications Writing (Adjustment Level): Page 6-20

7

User Calibration

7-1	User Calibration	7-2
7-2	Parameter Structure	7-3
7-3	Thermocouple Calibration	7-4
7-4	Resistance Thermometer Calibration	7-7
7-5	Calibrating Analog Input	7-9
7-6	Calibrating the Transfer Output	7-11
7-7	Checking Indication Accuracy	7-13

7-1 User Calibration

The E5CC/E5EC is correctly calibrated before it is shipped from the factory. Normally it does not need to be calibrated by the user.

If, however, it must be calibrated by the user, use the parameters for calibrating temperature input and analog input. OMRON, however, cannot ensure the results of calibration by the user. Also, calibration data is overwritten with the latest calibration results. The default calibration settings cannot be restored after user calibration. Perform user calibration with care.

● Calibrating Inputs

The input type selected in the parameter is used for calibration. The input types are as follows:

- Thermocouple: 16 types
- Infrared temperature sensor: 4 types
- Resistance thermometer: 5 types
- Current input: 2 types
- Voltage input: 3 types

● Registering Calibration Data

The new calibration data for each item is temporarily registered. It can be officially registered as calibration data only when all items have been calibrated to new values. Therefore, be sure to temporarily register all items when you perform the calibration. When the data is registered, it is also recorded that user calibration has been performed.

Prepare separate measuring devices and equipment for calibration. For details on how to handle measuring devices and equipment, refer to the respective instruction manuals.

7-2 Parameter Structure

- To execute user calibration, enter the password "1201" at the Move to Calibration Level parameter in the Advanced Function Setting Level. The mode will be changed to the calibration mode, and *Adj* will be displayed.
- The Move to Calibration Level parameter may not be displayed when the user is doing the calibration for the first time. If this happens, set the Initial Setting/Communications Protect parameter in the Protect Level to 0 before moving to the Advanced Function Setting Level.
- The calibration mode is ended by turning the power OFF.
- The parameter calibrations in the calibration mode are structured as shown below.

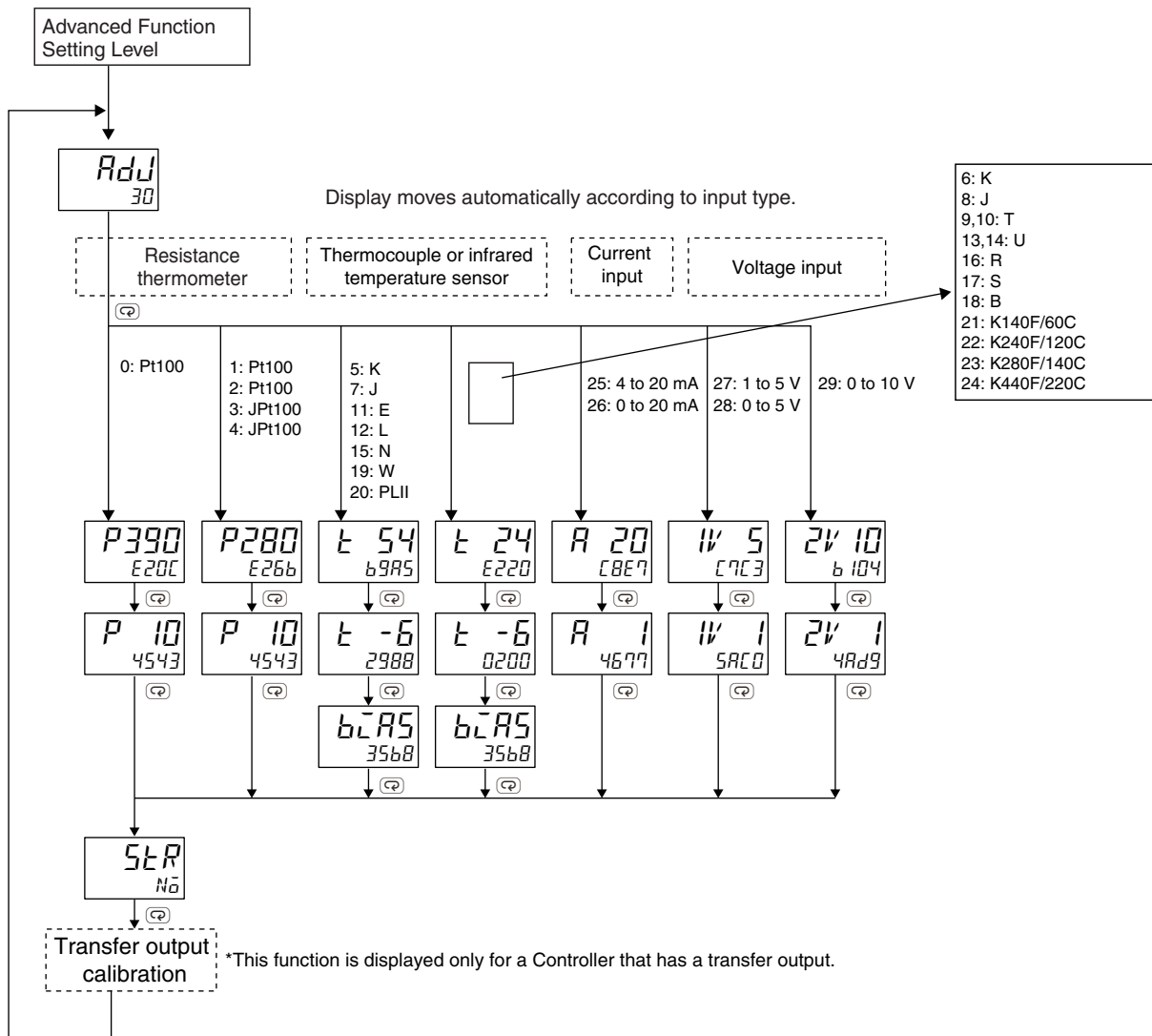

When calibration has been performed after purchase, the user calibration information shown in the following illustration will be displayed when moving to the Calibration Level.

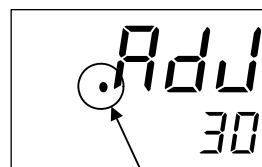

A dot is displayed.

7-3 Thermocouple Calibration

- Calibrate according to the type of thermocouple: thermocouple group 1 (input types 5, 7, 11, 12, 15, 19, and 20) and thermocouple group 2 (input types 6, 8, 9, 10, 13, 14, 16, 17, 18, 21, 22, 23, and 24).
- When calibrating, do not cover the bottom of the Controller. Also, do not touch the input terminals (terminals 5 and 6 on the E5CC and terminals 23 and 24 on the E5EC) or the compensating conductors.

● Preparations

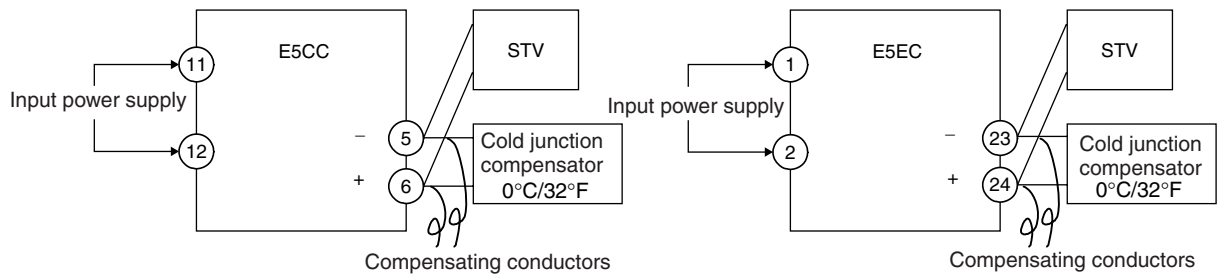

- Set the cold junction compensator designed for compensation of internal thermocouples to 0°C. Make sure that internal thermocouples are disabled (i.e., that tips are open).
- In the above figure, STV indicates a standard DC current/voltage source.
- Use the compensating conductor designed for the selected thermocouple. When thermocouples R, S, E, B, W, or PLII or an infrared temperature sensor is used, the cold junction compensator and the compensating conductor can be substituted with the cold junction compensator and the compensating conductor for thermocouple K.



Additional Information

Connecting the Cold Junction Compensator

Correct process values cannot be obtained if you touch the contact ends of the compensating conductor during calibration of a thermocouple. Accordingly, short-circuit (enable) or open (disable) the tip of the thermocouple inside the cold junction compensator as shown in the figure below to create a contact or non-contact state for the cold junction compensator.

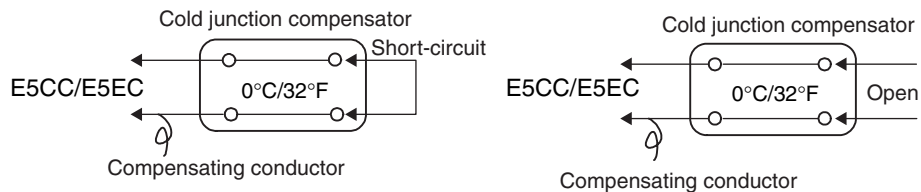

In this example, calibration is shown for a Controller with thermocouple/infrared temperature sensor set as the input type.

1. Connect the power supply.
2. Connect a standard DC current/voltage source (STV), precision digital multimeter (DMM), and contact junction compensator (e.g., a zero controller as in the figure) to the thermocouple input terminals, as shown in the figure below.

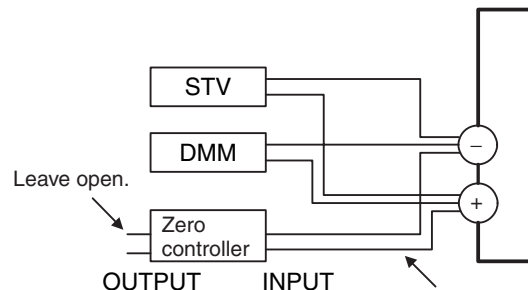

Compensating conductor of currently selected thermocouple.

Use K thermocouple compensating conductor for E, R, S, B, W, and PLII thermocouples and for an infrared temperature sensor.

3. Turn the power ON.
4. Move to the Calibration Level.

This starts the 30-minute aging timer. This timer provides an approximate timer for aging. After 30 minutes have elapsed, the No. 2 display changes to 0. You can advance to the next step in this procedure even if 0 is not displayed.

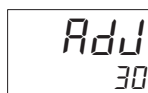



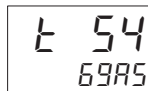

- Input types 5, 7, 11, 12, 15, 19, 20:

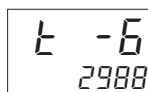
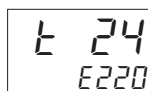

- Input types 6, 8, 9, 10, 13, 14, 16, 17, 18, 21, 22, 23, 24:



5. When the  Key is pressed, the status changes as shown to the left. The No. 2 display at this time shows the currently entered count value in hexadecimal. Set the STV as follows:
 - Input types 5, 7, 11, 12, 15, 19, 20: Set to 54 mV.
 - Input types 6, 8, 9, 10, 13, 14, 16, 17, 18, 21, 22, 23, 24: Set to 24 mV.
 Allow the count value on the No. 2 display to fully stabilize, then press the  Key to temporarily register the calibration settings. If this count value is outside of the specified range, the No. 2 display will flash and the count value will not be temporarily registered.
6. When the  Key is pressed, the status changes as shown to the left. Set the STV to -6 mV. Allow the count value on the No. 2 display to fully stabilize, then press the  Key to temporarily register the calibration settings. If this count value is outside of the specified range, the No. 2 display will flash and the count value will not be temporarily registered.

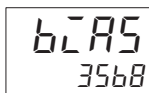

7. When the  Key is pressed, the status changes as shown to the left.

8. Change the wiring as follows:

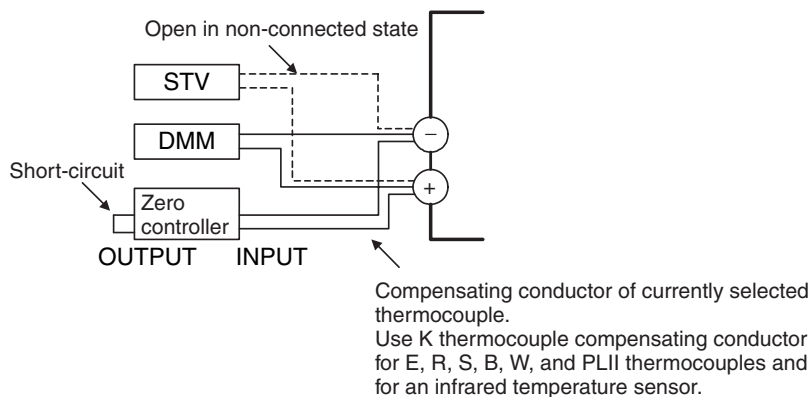



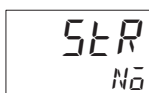

Disconnect the STV to enable the thermocouple of the cold junction compensator. When doing this, be sure to disconnect the wiring on the STV side.

9. Allow the count value on the No. 2 display to fully stabilize, then press the  Key to temporarily register the calibration settings.



10. When the  Key is pressed, the status changes as shown to the left.

The data to be temporarily registered is not displayed if it is not complete. Press the  Key. The No. 2 display changes to 4E5. Release the key and wait two seconds or press the  Key. This stores the temporarily registered calibration data to non-volatile memory. To cancel the saving of temporarily registered calibration data to non-volatile memory, press the  Key (while No is displayed in the No. 2 display) without pressing the  Key.

11. The calibration mode is ended by turning the power OFF.

For Controllers that have a transfer output, you can continue by calibrating the transfer output. For detailed setting methods, refer to 7-6 *Calibrating the Transfer Output*.

7-4 Resistance Thermometer Calibration

In this example, calibration is shown for Controller with a resistance thermometer set as the input type. Use connecting wires of the same thickness

1. Connect the power supply.
2. Connect a precision resistance box (called a "6-dial variable resistor" in this manual) to the resistance thermometer input terminals, as shown in the following diagram.

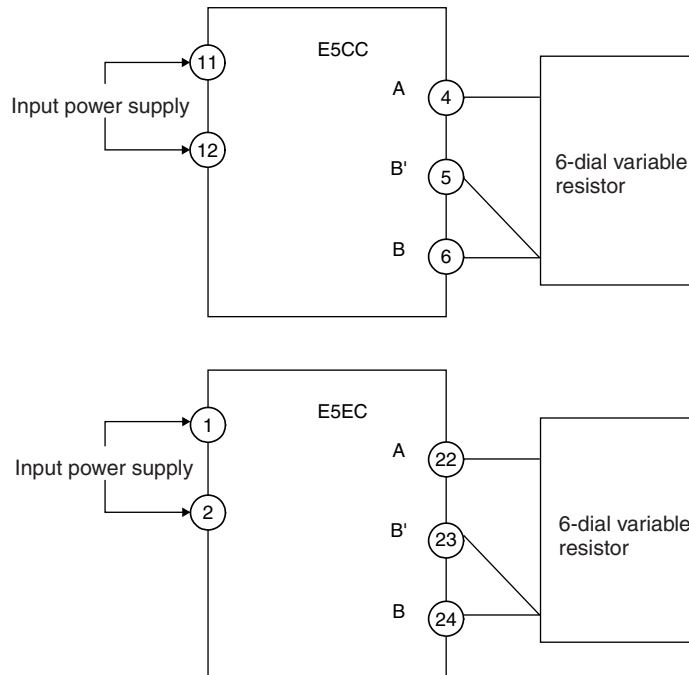

3. Turn the power ON.
4. Move to the Calibration Level.
This starts the 30-minute aging timer. This timer provides an approximate timer for aging. After 30 minutes have elapsed, the No. 2 display changes to 0. You can advance to the next step in this procedure even if 0 is not displayed.
5. Execute calibration for the main input.
Press the \square Key to display the count value for each input type. The No. 2 display at this time shows the currently entered count value in hexadecimal. Set the 6-dial as follows:
 - Input type 0: 390 Ω
 - Input type 1, 2, 3 or 4: 280 Ω
 Allow the count value on the No. 2 display to fully stabilize, then press the \triangleright Key to temporarily register the calibration settings. If this count value is outside of the specified range, the No. 2 display will flash and the count value will not be temporarily registered.
6. When the \square Key is pressed, the status changes as shown to the left.
Set the 6-dial to 10 Ω .
Allow the count value on the No. 2 display to fully stabilize, then press the \triangleright Key to temporarily register the calibration settings. If this count value is outside of the specified range, the No. 2 display will flash and the count value will not be temporarily registered.

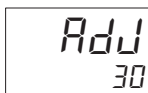



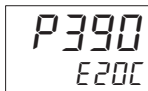

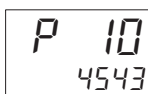
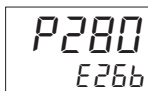

- Input type 0:

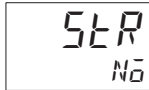

- Input types 1, 2, 3, 4:





7. When the  Key is pressed, the status changes as shown to the left.
The data to be temporarily registered is not displayed if it is not complete.
Press the  Key. The No. 2 display changes to *4E5*. Release the key and wait two seconds or press the  Key. This stores the temporarily registered calibration data to non-volatile memory.
To cancel the saving of temporarily registered calibration data to non-volatile memory, press the  Key (while *No* is displayed in the No. 2 display) without pressing the  Key.
8. The calibration mode is quit by turning the power OFF.
For Controllers that have a transfer output, you can continue by calibrating the transfer output. For detailed setting methods, refer to *7-6 Calibrating the Transfer Output*.

7-5 Calibrating Analog Input

● Calibrating a Current Input

In this example, calibration is shown for a Controller with an analog input, with a current input set as the input type.

1. Connect the power supply.
2. Connect an STV and DMM to the current input terminals, as shown in the following diagram.

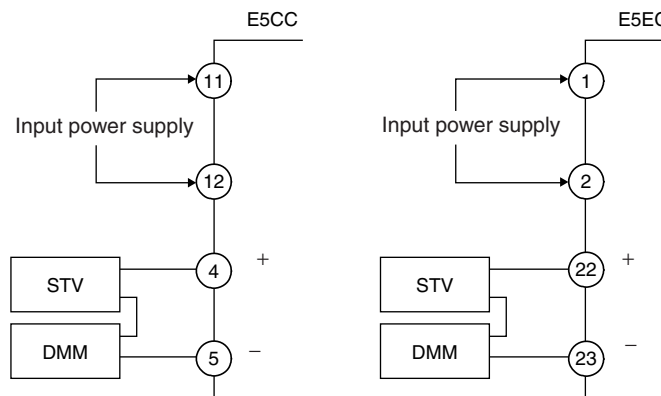

3. Turn the power ON.
4. Move to the Calibration Level.
This starts the 30-minute aging timer. This timer provides an approximate timer for aging. After 30 minutes have elapsed, the No. 2 display changes to 0. You can advance to the next step in this procedure even if 0 is not displayed.
5. When the Key is pressed, the status changes as shown to the left.
The No. 2 display at this time shows the currently entered count value in hexadecimal. Set the STV to 20 mA.
Allow the count value on the No. 2 display to fully stabilize, then press the Key to temporarily register the calibration settings.
If this count value is outside of the specified range, the No. 2 display will flash and the count value will not be temporarily registered.
6. When the Key is pressed, the status changes as shown to the left.
Set the STV to 1 mA.
Allow the count value on the No. 2 display to fully stabilize, then press the Key to temporarily register the calibration settings.
If this count value is outside of the specified range, the No. 2 display will flash and the count value will not be temporarily registered.
7. When the Key is pressed, the status changes as shown to the left.
The data to be temporarily registered is not displayed if it is not complete.
Press the Key. The No. 2 display changes to *4E5*. Release the key and wait two seconds or press the Key. This stores the temporarily registered calibration data to non-volatile memory.
To cancel the saving of temporarily registered calibration data to non-volatile memory, press the Key (while *No* is displayed in the No. 2 display) without pressing the Key.
8. The calibration mode is ended by turning the power OFF.
For Controllers that have a transfer output, you can continue by calibrating the transfer output. For detailed setting methods, refer to 7-6 *Calibrating the Transfer Output*.

Adj
30

A 20
[8E7]

A 1
4677

StR
No

● **Calibrating a Voltage Input**

In this example, calibration is shown for a Controller with an analog input, with a voltage input set as the input type.

1. Connect the power supply.
2. Connect an STV and DMM to the voltage input terminals, as shown in the following diagram.

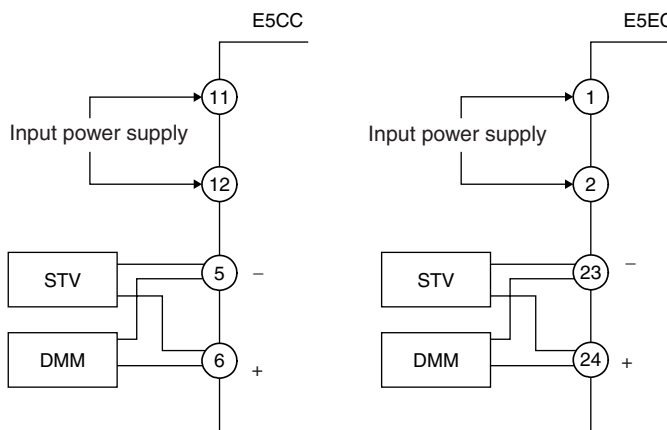

3. Turn the power ON.
4. Move to the Calibration Level.
This starts the 30-minute aging timer. This timer provides an approximate timer for aging. After 30 minutes have elapsed, the No. 2 display changes to 0. You can advance to the next step in this procedure even if 0 is not displayed.

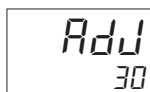

- Input type 27 or 28:

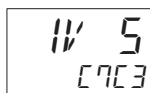

- Input type 29:

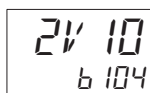

- Input type 27 or 28:



- Input type 29:

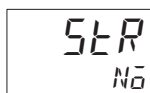
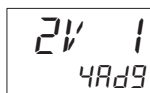

5. When the Key is pressed, the status changes as shown to the left. The No. 2 display at this time shows the currently entered count value in hexadecimal. Set the STV as follows:
 - Input type 27 or 28: 5 V
 - Input type 29: 10 V
 Allow the count value on the No. 2 display to fully stabilize, then press the Key to temporarily register the calibration settings. If this count value is outside of the specified range, the No. 2 display will flash and the count value will not be temporarily registered.

6. When the Key is pressed, the status changes as shown to the left. Set the STV to 1 V.

7. When the Key is pressed, the status changes as shown to the left. The data to be temporarily registered is not displayed if it is not complete. Press the Key. The No. 2 display changes to 4E5. Release the key and wait two seconds or press the Key. This stores the temporarily registered calibration data to non-volatile memory. To cancel the saving of temporarily registered calibration data to non-volatile memory, press the Key (while N0 is displayed in the No. 2 display) without pressing the Key.

8. The calibration mode is ended by turning the power OFF. For Controllers that have a transfer output, you can continue by calibrating the transfer output. For detailed setting methods, refer to 7-6 *Calibrating the Transfer Output*.

7-6 Calibrating the Transfer Output

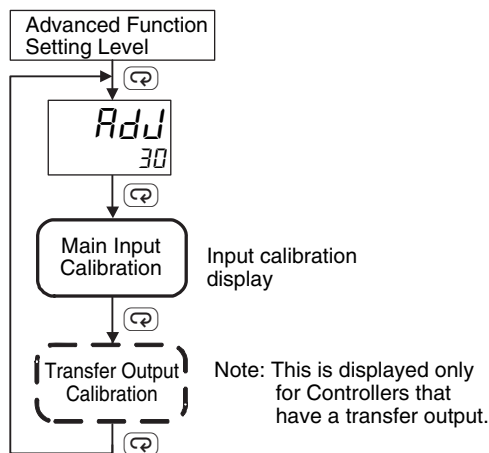

For Controllers that have a transfer output, the transfer output calibration display will be displayed after input calibration has been completed.

Use the following procedure to calibrate the transfer output for 4 to 20 mA.

1. Connect a DMM to the transfer output terminals.

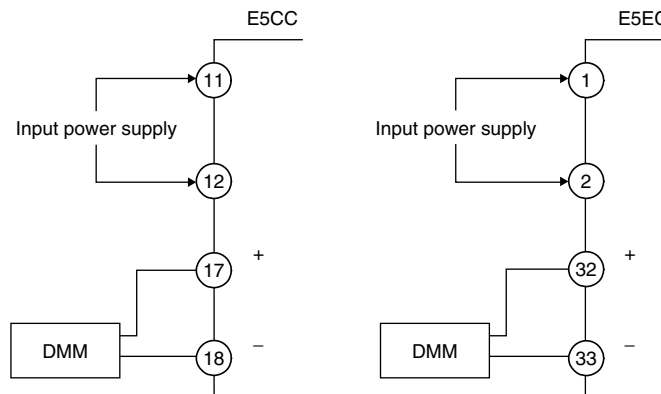

2. Press the \rightarrow Key to display the parameter for the transfer output.
3. The calibration display for 20 mA will be displayed. Press the \uparrow or \downarrow Key until the DMM monitor value changes to 20 mA. Press the \rightarrow Key. The calibration settings will be temporarily registered.
4. The calibration display for 4 mA will be displayed. Press the \uparrow or \downarrow Key until the DMM monitor value changes to 4 mA. Press the \rightarrow Key. The calibration settings will be temporarily registered.
5. To cancel saving the temporarily registered calibration data to non-volatile memory, press the \rightarrow Key without pressing the \uparrow Key, i.e., while $N\bar{0}$ is displayed in the No. 2 display. Press the \uparrow Key. The No. 2 display changes to $4E5$. Release the key and wait 2 seconds or press the \rightarrow Key. This saves the temporarily registered calibration data in non-volatile memory.
6. The Calibration Mode is ended by turning OFF the power supply.

5LR
N $\bar{0}$

A20.E
52AC

A4.E
0037

5LR.E
N $\bar{0}$

Use the following procedure to calibrate the transfer output for 1 to 5 V.

1. Connect a DMM to the transfer output terminals.

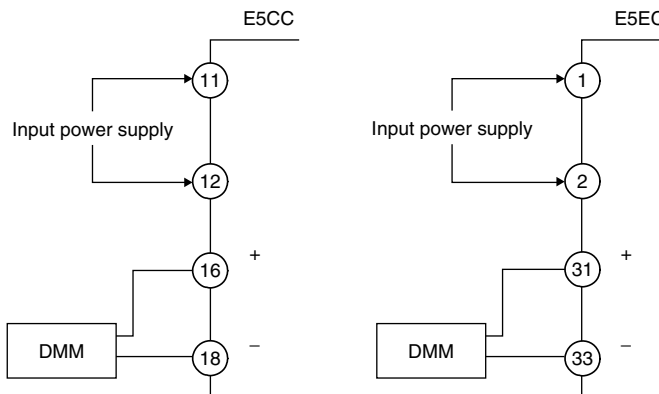

2. Press the ⏏ Key to display the parameter for the transfer output.

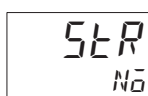

3. The calibration display for 5 V will be displayed. Press the ⏏ or ⏏ Key until the DMM monitor value changes to 5 V. Press the ⏏ Key. The calibration settings will be temporarily registered.

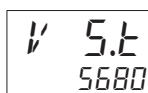

4. The calibration display for 1 V will be displayed. Press the ⏏ or ⏏ Key until the DMM monitor value changes to 1 V. Press the ⏏ Key. The calibration settings will be temporarily registered.

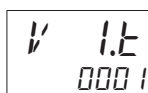

5. To cancel saving the temporarily registered calibration data to non-volatile memory, press the ⏏ Key without pressing the ⏏ Key, i.e., while No is displayed in the No. 2 display. Press the ⏏ Key. The No. 2 display changes to 4E5 . Release the key and wait 2 seconds or press the ⏏ Key. This saves the temporarily registered calibration data in non-volatile memory.

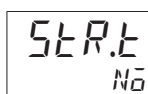

6. The Calibration Mode is ended by turning OFF the power supply.

7-7 Checking Indication Accuracy

- After calibrating the input, be sure to check the indication accuracy to make sure that the calibration has been executed correctly.
- Operate the E5CC/E5EC in the process value/set point monitor mode.
- Check the indication accuracy at the following three values: upper limit, lower limit, and mid-point.
- To check the range of an infrared sensor, set the input type parameter to 6 (i.e., a K thermocouple) and input a voltage that is equivalent to the starting power of a K thermocouple.

● Thermocouple or Infrared Temperature Sensor

- Preparations

The diagram below shows the required device connections. Make sure that the E5CC/E5EC and cold junction compensator are connected by a compensating conductor for the thermocouple that is to be used during actual operation.

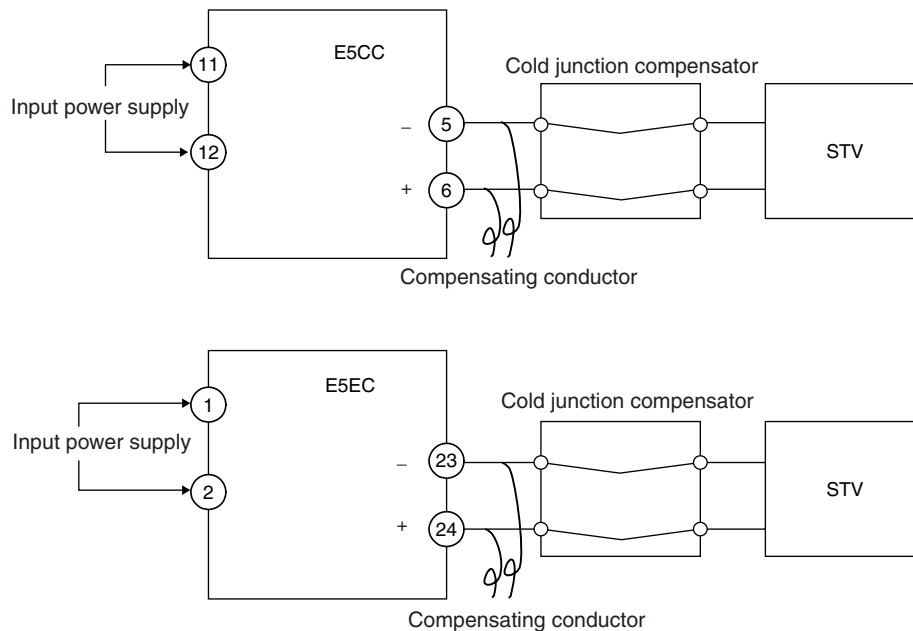

- Operation

Make sure that the cold junction compensator is at 0°C, and set the STV output to the voltage equivalent of the starting power of the check value.

The cold junction compensator and compensation conductor are not required when an external cold junction compensation method is used.

● **Resistance Thermometer**

- Preparations

The diagram below shows the required device connections.

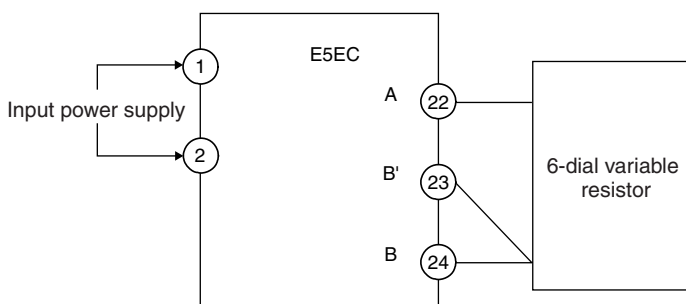
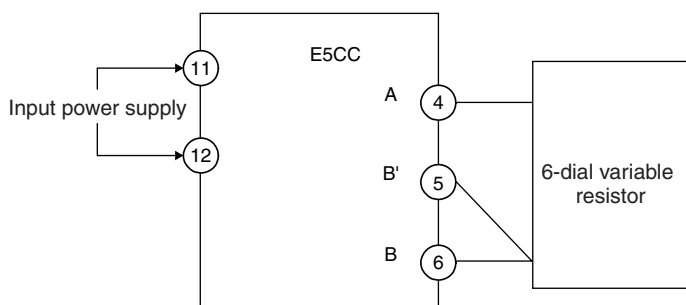

- Operation

Set the 6-dial variable resistor to the resistance that is equivalent to the test value.

● **Analog Input**

- Preparations

The diagram below shows the required device connections.

(The connection terminals depend on the model and input type.)

Current Input

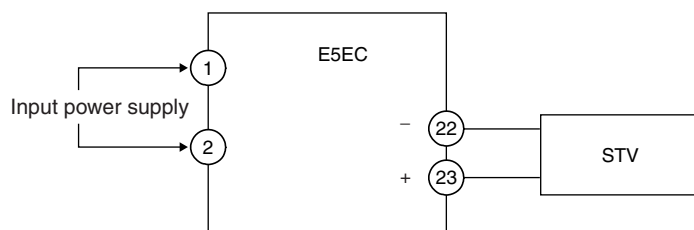
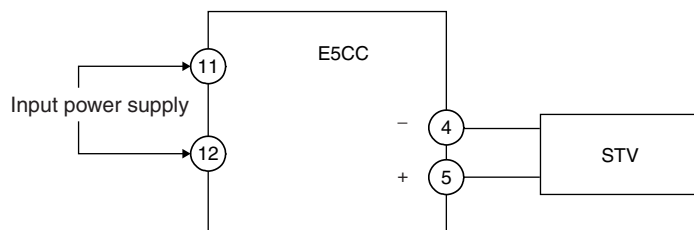

Voltage Input

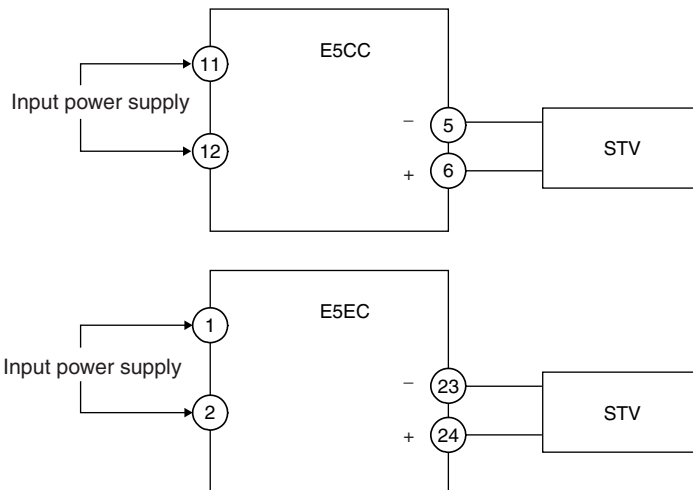

- Operation
Set the STV output to the voltage or current test value.

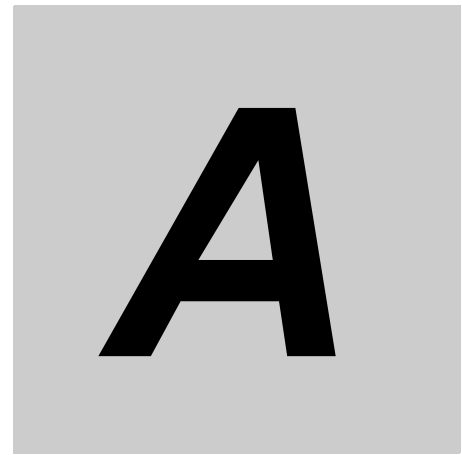

Appendices

A-1 Specifications	A-2
A-1-1 Ratings	A-2
A-1-2 Characteristics	A-4
A-1-3 Rating and Characteristics of Options	A-5
A-1-4 Waterproof Packing	A-5
A-2 Current Transformer (CT)	A-7
A-2-1 Specifications	A-7
A-2-2 Dimensions (Unit: mm)	A-7
A-3 USB-Serial Conversion Cable and Conversion Cable	A-8
A-3-1 E58-CIFQ2 USB-Serial Conversion Cable	A-8
A-3-2 E58-CIFQ2-E Conversion Cable	A-9
A-4 Error Displays	A-10
A-5 Troubleshooting	A-13
A-6 Parameter Operation Lists	A-16
A-6-1 Operation Level	A-16
A-6-2 Adjustment Level	A-17
A-6-3 Initial Setting Level	A-18
A-6-4 Manual Control Level	A-21
A-6-5 Monitor/Setting Item Level	A-21
A-6-6 Advanced Function Setting Level	A-22
A-6-7 Protect Level	A-26
A-6-8 Communications Setting Level	A-26
A-6-9 Initialization According to Parameter Changes	A-27
A-7 Sensor Input Setting Range, Indication Range, Control Range	A-30
A-8 Setting Levels Diagram	A-31
A-9 Parameter Flow	A-32

A

A-1 Specifications

A-1-1 Ratings

Supply voltage		100 to 240 VAC, 50/60 Hz	24 VAC, 50/60 Hz/24 VDC
Operating voltage range		85% to 110% of rated supply voltage	
Power consumption	E5CC	Option number 000: 5.2 VA max. Other option numbers: 6.5 VA max.	Option number 000: 3.1 VA max./1.6 W max. Other option numbers: 4.1 VA max./2.3 W max.
	E5EC	Option number 000: 6.6 VA max. Other option numbers: 8.3 VA max.	Option number 000: 4.1 VA max./2.3 W max. Other option numbers: 5.5 VA max./3.2 W max.
Sensor input ^{*1}		Thermocouple: K, J, T, E, L, U, N, R, S, B, W, PLII Platinum resistance thermometer: Pt100, JPt100 Infrared temperature sensor: 10 to 70°C, 60 to 120°C, 115 to 165°C, 140 to 260°C Current input ^{*2} : 4 to 20 mA, 0 to 20 mA (Input impedance: 150 Ω max.) Voltage input ^{*2} : 1 to 5 V, 0 to 5 V, 0 to 10 V (Input impedance: 1 MΩ min.)	
Control output 1/2	Relay output	E5CC	SPST-NO, 250 VAC, 3 A (resistive load), electrical durability: 100,000 operations Min. applicable load: 5 V, 10 mA ^{*3}
		E5EC	SPST-NO, 250 VAC, 5 A (resistive load), electrical durability: 100,000 operations Min. applicable load: 5 V, 10 mA
	Voltage output	E5CC	Output voltage 12 VDC ±20% (PNP), max. load current 21 mA, with short-circuit protection circuit
		E5EC	Control Output 1 Output voltage 12 VDC ±20% (PNP), max. load current 40 mA, with short-circuit protection circuit (21 mA if there are two control outputs) Control Output 2 Control output 2: 12 VDC ±20% (PNP), max. load current 21 mA, with short-circuit protection circuit
Current output		4 to 20 mA DC, 0 to 20 mA DC, Load: 500 Ω max. Resolution: Approx. 10,000 ^{*3}	
Auxiliary output	Relay outputs	Two Auxiliary Outputs SPST-NO, 250 VAC, 3 A (resistive load), electrical durability: 100,000 operations Min. applicable load: 5 V, 10 mA Three Auxiliary Outputs (E5CC) or Four Auxiliary Outputs (E5EC) SPST-NO, 250 VAC, 2 A (resistive load), electrical durability: 100,000 operations, Min. applicable load: 5 V, 10 mA	
Control method		2-PID or ON/OFF control	
Setting method		Digital setting using front panel keys	
Indication method		11-segment digital displays and individual indicators	
Other functions		Depend on the model	
Ambient temperature		-10 to 55°C (with no condensation or icing); with 3-year guarantee: -10 to 50°C	
Ambient humidity		25% to 85%	
Storage temperature		-25 to 65°C (with no condensation or icing)	
Altitude		2,000 m max.	
Recommended fuse		T2A, 250 VAC, time lag, low shut-off capacity	
Installation environment		Installation Category II, Pollution Class 2 (IEC 61010-1 compliant)	

*1 For input setting ranges, refer to *A-7 Sensor Input Setting Range, Indication Range, Control Range*.

*2 When connecting the ES2-HB/THB, connect it 1:1.

*3 With the E5CC, you cannot select a relay output or current output for control output 2.

● HB and HS Alarms

(E5CC/E5EC Models with HB and HS Alarms)

Max. heater current	50 A AC
Input current readout accuracy	±5% FS ±1 digit max.
Heater burnout alarm setting range	0.1 to 49.9 A (0.1 A units) 0.0 A: Heater burnout alarm output turns OFF. 50.0 A: Heater burnout alarm output turns ON. Min. detection ON time ^{*1} : 30 ms for a control period of 0.1 s or 0.2 s 100 ms for a control period of 0.5 s or 1 to 99 s
Heater short alarm setting range	0.1 to 49.9 A (0.1 A units) 0.0 A: Heater short alarm output turns ON. 50.0 A: Heater short alarm output turns OFF. Min. detection OFF time ^{*2} : 35 ms for a control period of 0.1 s or 0.2 s 100 ms for a control period of 0.5 s or 1 to 99 s

*1 HB alarms are not detected and the heater power is not measured if the ON time for the control output for heating is 100 ms or less (30 ms or less if the control period is 0.1 or 0.2 s).

*2 HS alarms are not detected and the leakage power is not measured if the ON time for the control output for heating is 100 ms or less (35 ms or less if the control period is 0.1 or 0.2 s).

A-1-2 Characteristics

Indication accuracy (ambient temperature of 23°C)	Thermocouple ^{*1}	(±0.3% of PV or ±1°C, whichever is greater) ±1 digit max.		
	Resistance thermometer	(±0.2% of PV or ±0.8°C, whichever is greater) ±1 digit max.		
	Analog input	±0.2% FS ±1 digit max.		
	CT input	±5% FS ±1 digit max.		
Temperature variation influence ^{*2} Voltage variation influence ^{*2}	Thermocouple	Thermocouple (R, S, B, W, PLII) (±1% of PV or ±10°C, whichever is greater) ±1 digit max. Other thermocouples: (±1% of PV or ±4°C, whichever is greater) ±1 digit max. *K thermocouple at -100°C max: ±10°C max.		
	Resistance thermometer	(±1% of PV or ±2°C, whichever is greater) ±1 digit max.		
	Analog input	±1% FS ±1 digit max.		
	CT input	±5% FS ±1 digit max.		
	Remote SP input	±1% FS ±1 digit max.		
Hysteresis	Temperature input	0.1 to 999.9°C or °F (in units of 0.1°C or °F)		
	Analog input	0.01% to 99.99% FS (in units of 0.01% FS)		
Proportional band (P)	Temperature input	0.1 to 999.9°C or °F (in units of 0.1°C or °F)		
	Analog input	0.1% to 999.9% FS (in units of 0.1% FS)		
Integral time (I) ^{*3}	0 to 9,999 s (in units of 1 s) 0.0 to 999.9 s (in units of 0.1 s)			
Derivative time (D) ^{*3}	0 to 9,999 s (in units of 1 s) 0.0 to 999.9 s (in units of 0.1 s)			
Control Period	0.1, 0.2, 0.5, or 1 to 99 s (in units of 1 s)			
Manual reset value	0.0% to 100.0% (in units of 0.1%)			
Alarm setting range	-1,999 to 9,999 (decimal point position depends on input type)			
Sampling cycle	50 ms			
Insulation resistance	20 MΩ min. (at 500 VDC)			
Dielectric strength	2,300 VAC, 50/60 Hz for 1 min between terminals of different charge			
Malfunction vibration	10 to 55 Hz, 20 m/s ² for 10 min each in X, Y and Z directions			
Vibration resistance	10 to 55 Hz, 20 m/s ² for 2 hr each in X, Y, and Z directions			
Malfunction shock	100 m/s ² , 3 times each in X, Y, and Z directions			
Shock resistance	300 m/s ² , 3 times each in X, Y, and Z directions			
Weight	E5CC	Approx. 120 g	Adapter: Approx. 10 g	Terminal cover: Approx. 0.5 g each
	E5EC	Approx. 210 g	Adapter: Approx. 4 g × 2	Terminal Cover: Approx. 1 g each
Degree of protection	Front panel: IP66, rear case: IP20, terminals: IP00			
Memory protection	Non-volatile memory (number of writes: 1,000,000)			

*1 The indication accuracy of K, T, and N thermocouples at a temperature of -100°C or less is ±2°C ±1 digit maximum.
The indication accuracy of U and L thermocouples is ±2°C ±1 digit maximum.
The indication accuracy of B thermocouples at a temperature of 400°C or less is not specified.
The indication accuracy of B thermocouples at a temperature of 400 to 800°C is ±3°C maximum.
The indication accuracy of R and S thermocouples at a temperature of 200°C or less is ±3°C ±1 digit maximum.
The indication accuracy of W thermocouples is (±0.3% of PV or ±3°C, whichever is greater) ±1 digit maximum.
The indication accuracy of PLII thermocouples is (±0.3% of PV or ±2°C, whichever is greater) ±1 digit maximum.

*2 Ambient temperature: -10°C to 23°C to 55°C
Voltage range: -15 to +10% of rated voltage



*3 The unit is determined by the setting of the Integral/Derivative Time Unit parameter.

A-1-3 Rating and Characteristics of Options

Event inputs	Contact Input ON: 1 k Ω max., OFF: 100 k Ω min.
	Non-contact Input ON: Residual voltage 1.5 V max.; OFF: Leakage current 0.1 mA max.
Communications	Transmission path: RS-485
	Communications method: RS-485 (2-wire, half duplex)
	Synchronization: Start-stop
	Baud rate: 9.6, 19.2, 38.4, or 57.6 kbps
Transfer output	Current output: 4 to 20 mA DC, Load: 500 Ω max., Resolution: 10,000 \pm 0.3%
	Linear voltage output: 1 to 5 VDC, Load: 1 k Ω min., Resolution: 10,000 \pm 0.3%
Remote SP input	Current input: 4 to 20 or 0 to 20 mA DC with input impedance of 150 Ω max.
	Voltage input: 1 to 5, 0 to 5, or 0 to 10 VDC with input impedance of 1 M Ω min.

A-1-4 Waterproof Packing

If the Waterproof Packing is lost or damage, order one of the following models.

Y92S-P8 (for DIN 48 \times 48)	Y92S-P9 (for DIN 48 \times 96)
	

A-1-5 Setup Tool Port Cover for Front Panel

A Y92F-P7 Setup Tool Port Cover for the front panel is included with the E5EC. Order this Port Cover separately if the Port Cover on the front-panel Setup Tool port is lost or damaged. The Waterproof Packing must be periodically replaced because it may deteriorate, shrink, or harden depending on the operating environment.

Y92S-P7



Use the following procedure to replace the Setup Tool Port Cover for the front panel.

● Replacement Procedure

<p>1 Open the Setup Tool Port Cover on the front panel.</p>	
<p>2 Pull gently on the Setup Tool Port Cover to remove it from the Digital Controller.</p>	
<p>3 Insert the stopper on the Setup Tool Port Cover into the hole at the bottom of the port.</p>	
<p>4 Make sure that the Setup Tool Port Cover is closed.</p>	

A-2 Current Transformer (CT)

A-2-1 Specifications

Item	Specifications	
Model number	E54-CT1	E54-CT3
Max. continuous current	50 A	120 A *1
Dielectric strength	1,000 VAC (for 1 min)	
Vibration resistance	50 Hz, 98 m/s ²	
Weight	Approx. 11.5 g	Approx. 50 g
Accessories	None	Armature (2), Plug (2)

*1 The maximum continuous current of the E5CC/E5EC is 50 A.

A-2-2 Dimensions (Unit: mm)

- E54-CT1

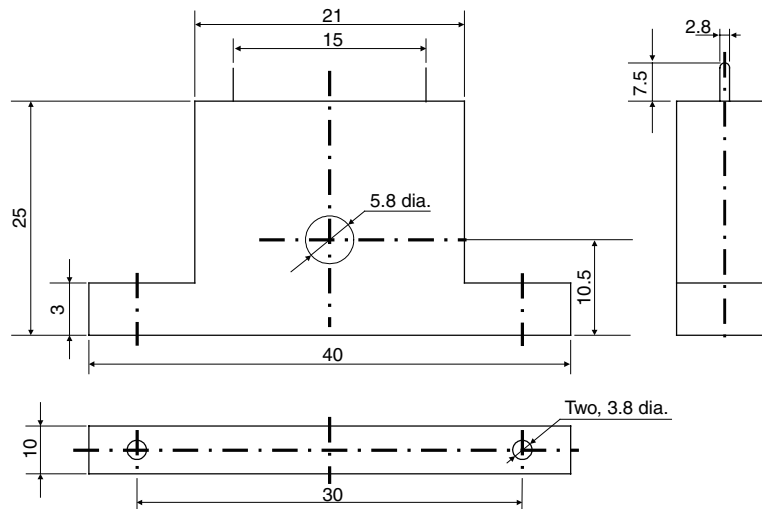

- E54-CT3

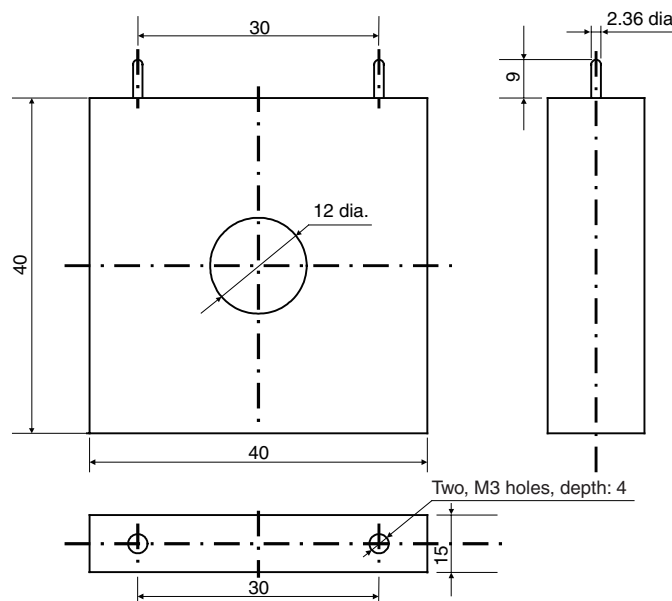

A-3 USB-Serial Conversion Cable and Conversion Cable

A USB-Serial Conversion Cable is used to connect the E5CC/E5EC to a computer. The E58-CIFQ2-E Conversion Cable is also required to connect to the Setup Tool port on the front panel of the E5EC. The following table lists the cables and ports that are used.

Model	Connection port	Cable
E5CC	Top-panel Setup Tool port	E58-CIFQ2 USB-Serial Conversion Cable
E5EC	Top-panel Setup Tool port	E58-CIFQ2 USB-Serial Conversion Cable
	Front-panel Setup Tool port	E58-CIFQ2 USB-Serial Conversion Cable and E58-CIFQ2-E Conversion Cable

Refer to 2-4 *Using the Setup Tool Port* for the connection procedure.

A-3-1 E58-CIFQ2 USB-Serial Conversion Cable

● Specifications

Item	Specifications
Applicable OS	Windows 2000, XP, Vista, or 7
Applicable software	CX-Thermo
Applicable models	E5CB Series and E5CC/E5EC Series
USB interface rating	Conforms to USB Specification 2.0
DTE speed	38,400 bps
Connector specifications	Computer end: USB (type A plug) Digital Controller: Special serial connector
Power supply	Bus power (Supplied from USB host controller)
Power supply voltage	5 VDC
Current consumption	450 mA max.
Output voltage	4.7±0.2 VDC (Supplied through USB-Serial Conversion Cable to the Digital Controller.)
Output current	250 mA max. (Supplied through USB-Serial Conversion Cable to the Digital Controller.)
Ambient temperature	0 to 55°C (with no condensation or icing)
Ambient humidity	10% to 80%
Storage temperature	-20 to 60°C (with no condensation or icing)
Storage humidity	10% to 80%
Altitude	2,000 m max.
Weight	Approx. 120 g

Note: Use a high-power port for the USB port.

● Dimensions

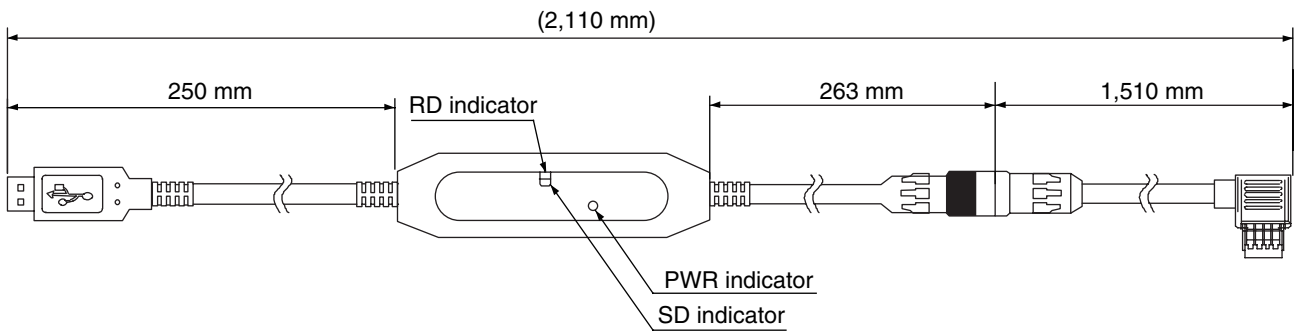

LED Indicator Display

Indicator	Color	Status	Meaning
PWR	Green	Lit.	USB bus power is being supplied.
		Not lit.	USB bus power is not being supplied.
SD	Yellow	Lit	Sending data from USB-Serial Conversion Cable
		Not lit	Not sending data from USB-Serial Conversion Cable
RD	Yellow	Lit	Receiving data from the USB-Serial Conversion Cable
		Not lit	Not receiving data from the USB-Serial Conversion Cable

A-3-2 E58-CIFQ2-E Conversion Cable

● Specifications

Item	Specification
Applicable models	E5EC Series
Connector specifications	Digital Controller: 4-pin plug E58-CIFQ2: Small special connector
Ambient temperature	0 to 55°C (with no condensation or icing)
Ambient humidity	10% to 80%
Storage temperature	-20 to 60°C (with no condensation or icing)
Storage humidity	10% to 80%
Altitude	2,000 m max.
Weight	Approx. 60 g

● Dimensions

E58-CIFQ2-E Conversion Cable

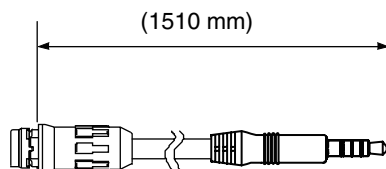

Connected to the E58-CIFQ2 USB-Serial Conversion Cable

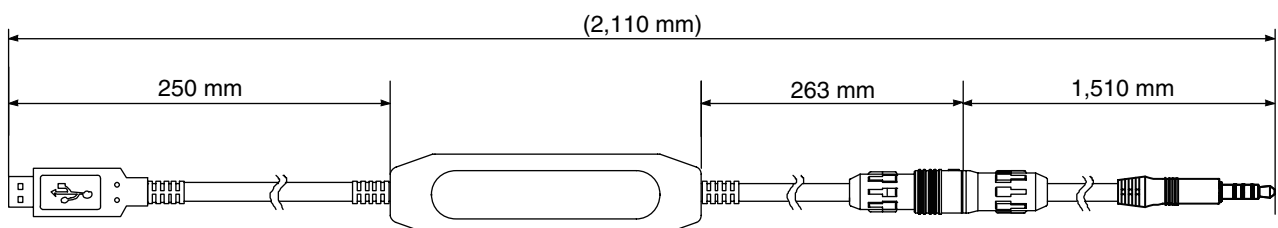

A-3 USB-Serial Conversion Cable and Conversion Cable

A

A-3-2 E58-CIFQ2-E Conversion Cable

A-4 Error Displays

When an error occurs, the error contents are shown on the No. 1 or the No. 2 display.
This section describes how to check error codes on the display, and the actions to be taken to remedy the problems.

S.ERR Input Error

● Meaning

The input value has exceeded the control range. *

The input type setting is not correct.

The sensor is disconnected or shorted.

The sensor wiring is not correct.

The sensor is not wired.

* Control Range

Resistance thermometer, thermocouple input:	Temperature setting lower limit -20°C to temperature setting upper limit $+20^{\circ}\text{C}$ (Temperature setting lower limit -40°F to temperature setting upper limit $+40^{\circ}\text{F}$)
ES1B input:	Same as input indication range
Analog input:	-5% to $+105\%$ of scaling range

● Action

Check the wiring of inputs for miswiring, disconnections, and short-circuits and check the input type.

If no abnormality is found in the wiring and input type, turn the power OFF then back ON again.

If the display remains the same, the Controller must be replaced. If the display is restored, then the probable cause is electrical noise affecting the control system. Check for electrical noise.

Note: With resistance thermometer input, a break in the A, B, or B' line is regarded as a disconnection.

● Operation

After an error occurs, the error is displayed and the alarm outputs function as if the upper limit has been exceeded.

It will also operate as if transfer output exceeded the upper limit. If an input error is assigned to a control output or auxiliary output, the output will turn ON when the input error occurs. The error message will appear in the display for the PV.

Note: The heating and cooling control outputs will turn OFF. When the manual MV, MV at stop, or MV at error is set, the control output is determined by the set value.

cccc
kkkk

Display Range Exceeded

● **Meaning**

Though this is not an error, it is displayed if the process value exceeds the display range when the control range is larger than the display range.

The display ranges are shown below (with decimal points omitted).

- When less than -1,999: ccccc
- When more than 9,999: kkkk

● **Operation**

Control continues, allowing normal operation. The value will appear in the display for the PV.

Resistance thermometer input (Except for models with a setting range of -199.9 to 500.0°C)
Thermocouple input (Except for models with a setting range of -199.9 to 400.0°C)
ES1B

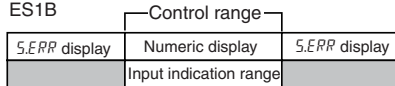

- Analog Input
- When display range < control range

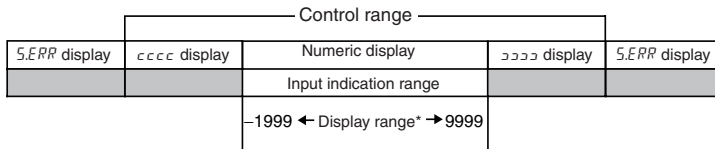

Resistance thermometer input (Except for models with a setting range of -1999. to 500.0°C)
Thermocouple input (Except for models with a setting range of -199.9 to 400.0°C)

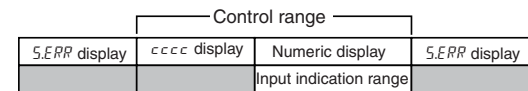

- Analog Input
- When display range ≥ control range

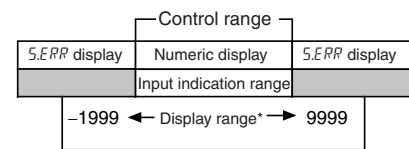

*The display range is shown in numbers with decimal points omitted.

E333

AD Converter Error

● **Meaning**

There is an error in internal circuits.

● **Action**

First, turn the power OFF then back ON again. If the display remains the same, the Controller must be repaired. If the display is restored, then the probable cause is electrical noise affecting the control system. Check for electrical noise.

● **Operation**

The control, auxiliary, and transfer outputs turn OFF. (A current output will be approx. 0 mA. A linear voltage output will be approx. 0 V.)

E111 **Memory Error**

- **Meaning**

Internal memory operation is in error.

- **Action**

First, turn the power OFF then back ON again. If the display remains the same, the Controller must be repaired. If the display is restored, then the probable cause is electrical noise affecting the control system. Check for electrical noise.

- **Operation**

The control, auxiliary, and transfer outputs turn OFF. (A current output will be approx. 0 mA. A linear voltage output will be approx. 0 V.)

FFFF **Current Value Exceeds**

- **Meaning**

This error is displayed when the heater current value exceeds 55.0 A.

- **Operation**

Control continues, allowing normal operation. An error message is displayed when the following items are displayed.

Heater current 1 value monitor

Heater current 2 value monitor

Leakage current 1 monitor

Leakage current 2 monitor

EE1	
EE2	HB Alarm
LER1	HS Alarm
LER2	

- **Meaning**

If there is an HB or HS alarm, the relevant parameter will flash on the No. 1 display.

- **Operation**

The relevant Heater Current 1 Value Monitor, Heater Current 2 Value Monitor, Leakage Current 1 Monitor, or Leakage Current 2 Monitor parameters in the Operation or Adjustment Level will flash on the No. 1 display. However, control continues and operation is normal.

A-5 Troubleshooting

Checking Problems

If the Digital Controller is not operating normally, check the following points before requesting repairs. If the problem persists, contact your OMRON representative for details on returning the product.

Timing	Status	Meaning	Countermeasures	Page
Turning ON the power for the first time	The TUNE indicator will flash.	ST (self-tuning) is in progress (default setting: ON).	This is not a product fault. The TUNE indicator flashes during self-tuning.	4-25
	Temperature error is large. Input error (S.Err display)	Input type mismatch	Check the sensor type and reset the input type correctly.	4-11
		Thermometer is not installed properly.	Check the thermometer installation location and polarity and install correctly.	2-8, 2-12
	Communications are not possible.	Non-recommended adapter is being used.	Make sure that the connected device is not faulty.	*
During operation	Overshooting Undershooting Hunting	ON/OFF control is enabled (default: ON/OFF control selected).	Select PID control and execute either ST (self-tuning) or AT (auto-tuning). When using self-tuning, turn ON the power supply to the Digital Controller and load (heater, etc.) at the same time, or turn ON the load power supply first. Accurate self-tuning and optimum control will not be possible if the power supply to the load is turned ON after turning ON the power supply to the Digital Controller.	4-23
		Control period is longer compared with the speed of rise and fall in temperature.	Shorten the control period. A shorter control period improves control performance, but a cycle of 20 ms minimum is recommended in consideration of the service life of the relays.	4-14
		Unsuitable PID constant	Set appropriate PID constants using either of the following methods. <ul style="list-style-type: none"> Execute AT (autotuning). Set PID constants individually using manual settings. 	4-23
		HS alarm operation fault	Use breeder resistance if the problem is due to leakage current. Also investigate the errors detected by the HS alarm function.	4-41
	Temperature is not rising	Specified operation is unsuitable for required control (default: Reverse operation).	Select either forward or reverse operation depending on the required control. Reverse operation is used for heating operations.	4-14
		Heater is burnt out or deteriorated.	Check whether heater burnout or deterioration have occurred. Also investigate the errors detected by the heater burnout alarm.	4-39
		Insufficient heater capacity	Check whether the heater's heating capacity is sufficient.	---
		Cooling system in operation.	Check whether a cooling system is operating.	---
		Peripheral devices have heat prevention device operating.	Set the heating prevention temperature setting to a value higher than the set temperature of the Digital Controller.	---

* Refer to the *E5CC/E5EC Digital Temperature Controllers Communications Manual* (Cat. No. H175) for details.

Timing	Status	Meaning	Countermeasures	Page
During operation (continued)	Output will not turn ON	Set to STOP (default: RUN)	Set the RUN/STOP mode to RUN. If STOP is lit on the display, control is stopped.	5-12
		Specified operation is unsuitable for required control (default: Reverse operation).	Select either forward or reverse operation depending on the required control. Reverse operation is used for heating operations.	4-14
		A high hysteresis is set for ON/OFF operation (default: 1.0°C)	Set a suitable value for the hysteresis.	4-20
		The specified power is not being supplied from the terminals.	The output will not turn ON while the Digital Controller is being operated with power supplied through the USB-Serial Conversion Cable. Supply the specified power from the terminals.	---
	Temperature Controller will not operate	Set to STOP (default: RUN)	Set the RUN/STOP mode to RUN. If STOP is lit on the display, control is stopped.	5-12
	Temperature error is large Input error (S.err display)	Thermometer has burnt out or short-circuited.	Check whether the thermometer has burnt out or short-circuited.	---
		Thermometer lead wires and power lines are in the same conduit, causing noise from the power lines (generally, display values will be unstable).	Wire the lead wires and power lines in separate conduits, or wire them using a more direct path.	---
		Connection between the Digital Controller and thermocouple is using copper wires.	Connect the thermocouple's lead wires directly, or connect a compensating conductor suitable for the thermocouple.	---
		Installation location of thermometer is unsuitable.	Make sure that the location that is being measured with the temperature sensor is suitable.	---
		Input shift is not set correctly (default: 0°C)	Set a suitable input shift. If input shift is not required, set the input shift value to 0.0.	5-3
Keys will not operate		Setting change protect is ON.	Turn OFF setting change protect.	5-19
Cannot shift levels	Operations limited due to protection.	Set the operation/adjustment protect, initial setting/communications protect, and setting change protect values as required.	5-20	
After long service life	Control is unstable	Terminal screws may be loose.	Retighten terminal screws to a torque of 0.43 to 0.58 N-m.	2-16
		The internal components have reached the end of their service life.	The Digital Controller's internal electrolytic capacitor depends on the ambient temperature, and load rate. The structural life depends on the ambient environment (shock, vibration). The life expectancy of the output relays varies greatly with the switching capacity and other switching conditions. Always use the output relays within their rated load and electrical life expectancy. If an output relay is used beyond its life expectancy, its contacts may become welded or burned. Replace the Digital Controller and all other Digital Controllers purchased in the same time period.	---

Symptom: Cannot Communicate or a Communications Error Occurs

Meaning	Countermeasures
The communications wiring is not correct.	Correct the wiring.
The communications line has become disconnected.	Connect the communications line securely and tighten the screws.
The communications cable is broken.	Replace the cable.
The communications cable is too long.	The total cable length for RS-485 is 500 m max.
The wrong communications cable has been used.	Use a shielded, AWG24 to AWG18 (cross-sectional area of 0.205 to 0.823 mm ²) twisted-pair cable for the communications cable.
More than the specified number of communications devices are connected to the same communications path.	When 1:N communications are used, a maximum of 32 nodes may be connected, including the host node.
An end node has not been set at each end of the communications line.	Set or connect terminating resistance at each end of the line. If the E5CC/E5EC is the end node, 120-Ω (1/2-W) terminating resistance is used. Be sure that the combined resistance with the host device is 54 Ω minimum.
The specified power supply voltage is not being supplied to the Controller.	Supply the specified power supply voltage.
The specified power supply voltage is not being supplied to an Interface Converter (such as the K3SC).	Supply the specified power supply voltage.
The same baud rate and communications method are not being used by all of the Controllers, host devices, and other devices on the same communications line.	Set the same values for the baud rate, protocol, data length, stop bits, and parity on all nodes.
The unit number specified in the command frame is different from the unit number set by the Controller.	Use the same unit number.
The same unit number as the Controller is being used for another node on the same communications line.	Set each unit number for only one node.
There is a mistake in programming the host device.	Use a line monitor to check the commands. Check operation using a sample program.
The host device is detecting the absence of a response as an error before it receives the response from the Controller.	Shorten the send data wait time in the Controller or increase the response wait time in the host device.
The host device is detecting the absence of a response as an error after broadcasting a command.	The Controller does not return responses for broadcast commands.
The host device sent another command before receiving a response from the Controller.	The response must always be read after sending a command (except for broadcast commands).
The host device sent the next command too soon after receiving a response from the Controller.	After receiving a response, wait at least 2 ms before sending the next command.
The communications line became unstable when Controller power was turned ON or interrupted, and the host device read the unstable status as data.	Initialize the reception buffer in the host device before sending the first command and after turning OFF the power to the Controller.
The communications data was corrupted from noise from the environment.	Try using a slower baud rate. Separate the communications cable from the source of noise. Use a shielded, twisted-pair cable for the communications cable. Use as short a communications cable as possible, and do not lay or loop extra cable. To prevent inductive noise, do not run the communications cable parallel to a power line. If noise countermeasures are difficult to implement, use an Optical Interface.

* Refer to the *E5CC/E5EC Digital Temperature Controllers Communications Manual* (Cat. No. H175) for error details.

A-6 Parameter Operation Lists

A-6-1 Operation Level

Parameters	Characters	Setting (monitor) value	Display	Default	Unit
Process Value		Temperature: According to indication range for each sensor. Analog: Scaling lower limit -5% FS to Scaling upper limit +5% FS			EU
Set Point		SP lower limit to SP upper limit		0	EU
Multi-SP Set Point Selection	<i>M-SP</i>	0 to 7		0	None
Remote SP Monitor	<i>RSP</i>	Remote SP lower limit -10%FS to remote SP upper limit + 10%FS			EU
Set Point During SP Ramp	<i>SP-M</i>	SP lower limit to SP upper limit			EU
Heater Current 1 Value Monitor	<i>EE1</i>	0.0 to 55.0			A
Heater Current 2 Value Monitor	<i>EE2</i>	0.0 to 55.0			A
Leakage Current 1 Monitor	<i>LER1</i>	0.0 to 55.0			A
Leakage Current 2 Monitor	<i>LER2</i>	0.0 to 55.0			A
Program Start	<i>PRSt</i>	RSET, STRT	<i>RSEt, StRt</i>	RSET	None
Soak Time Remain	<i>SKtR</i>	0 to 9999			min or h
RUN/STOP	<i>R-S</i>	RUN/STOP	<i>RUN, StOP</i>	Run	None
Alarm Value 1	<i>RL-1</i>	All alarms except for MV absolute-value upper-limit or lower-limit alarms: -1,999 to 9,999 MV absolute-value upper-limit or lower-limit alarms: -199.9 to 999.9		0 0.0	EU %
Alarm Value Upper Limit 1	<i>RL1H</i>	-1,999 to 9,999		0	EU
Alarm Value Lower Limit 1	<i>RL1L</i>	-1,999 to 9,999		0	EU
Alarm Value 2	<i>RL-2</i>	All alarms except for MV absolute-value upper-limit or lower-limit alarms: -1,999 to 9,999 MV absolute-value upper-limit or lower-limit alarms: -199.9 to 999.9		0 0.0	EU %
Alarm Value Upper Limit 2	<i>RL2H</i>	-1,999 to 9,999		0	EU
Alarm Value Lower Limit 2	<i>RL2L</i>	-1,999 to 9,999		0	EU
Alarm Value 3	<i>RL-3</i>	All alarms except for MV absolute-value upper-limit or lower-limit alarms: -1,999 to 9,999 MV absolute-value upper-limit or lower-limit alarms: -199.9 to 999.9		0 0.0	EU %
Alarm Value Upper Limit 3	<i>RL3H</i>	-1,999 to 9,999		0	EU
Alarm Value Lower Limit 3	<i>RL3L</i>	-1,999 to 9,999		0	EU
Alarm Value 4	<i>RL-4</i>	All alarms except for MV absolute-value upper-limit or lower-limit alarms: -1,999 to 9,999 MV absolute-value upper-limit or lower-limit alarms: -199.9 to 999.9		0 0.0	EU %
Alarm Value Upper Limit 4	<i>RL4H</i>	-1,999 to 9,999		0	EU
Alarm Value Lower Limit 4	<i>RL4L</i>	-1,999 to 9,999		0	EU
MV Monitor (Heating)	<i>ō</i>	-5.0 to 105.5 (standard) 0.0 to 105.0 (heating/cooling)			%
MV Monitor (Cooling)	<i>ē-ō</i>	0.0 to 105.0			%

A-6-2 Adjustment Level

Parameters	Characters	Setting (monitor) value	Display	Default	Unit
Adjustment Level Display	<i>L.RdJ</i>				
AT Execute/Cancel	<i>At</i>	OFF, AT Cancel AT-2: 100%AT Execute AT-1: 40%AT Execute	<i>OFF, At-2, At-1</i>	OFF	None
Communications Writing	<i>CMWt</i>	OFF, ON	<i>OFF, ON</i>	OFF	None
SP Mode	<i>SPMd</i>	LSP, RSP	<i>LSP, RSP</i>	LSP	None
Heater Current 1 Value Monitor	<i>Et1</i>	0.0 to 55.0			A
Heater Burnout Detection 1	<i>Hb1</i>	0.0 to 50.0		0.0	A
Heater Current 2 Value Monitor	<i>Et2</i>	0.0 to 55.0			A
Heater Burnout Detection 2	<i>Hb2</i>	0.0 to 50.0		0.0	A
Leakage Current 1 Monitor	<i>LCR1</i>	0.0 to 55.0			A
HS Alarm 1	<i>HS1</i>	0.0 to 50.0		50.0	A
Leakage Current 2 Monitor	<i>LCR2</i>	0.0 to 55.0			A
HS Alarm 2	<i>HS2</i>	0.0 to 50.0		50.0	A
SP 0	<i>SP-0</i>	SP lower limit to SP upper limit		0	EU
SP 1	<i>SP-1</i>	SP lower limit to SP upper limit		0	EU
SP 2	<i>SP-2</i>	SP lower limit to SP upper limit		0	EU
SP 3	<i>SP-3</i>	SP lower limit to SP upper limit		0	EU
SP 4	<i>SP-4</i>	SP lower limit to SP upper limit		0	EU
SP 5	<i>SP-5</i>	SP lower limit to SP upper limit		0	EU
SP 6	<i>SP-6</i>	SP lower limit to SP upper limit		0	EU
SP 7	<i>SP-7</i>	SP lower limit to SP upper limit		0	EU
Process Value Input Shift	<i>INS</i>	Temperature input: -199.9 to 999.9		0.0	°C or °F
		Analog input: -1,999 to 9,999		0	EU
Process Value Slope Coefficient	<i>INRt</i>	0.001 to 9.999		1.000	None
Remote SP Input Shift	<i>RSS</i>	Temperature input: -199.9 to 999.9		0.0	°C or °F
		Analog input: -1,999 to 9,999		0	EU
Remote SP Input Slope Coefficient	<i>RSRt</i>	0.001 to 9.999		1.000	None
Proportional Band	<i>P</i>	Temperature input: 0.1 to 999.9		8.0	°C or °F
		Analog input: 0.1 to 999.9		10.0	%FS
Integral Time	<i>I</i>	Integral/Derivative Time Unit of 1 s: 0 to 9,999		233	Seconds
		Integral/Derivative Time Unit of 0.1 s: 0.0 to 999.9		233.0	
Derivative Time	<i>d</i>	Integral/Derivative Time Unit of 1 s: 0 to 9,999		40	Seconds
		Integral/Derivative Time Unit of 0.1 s: 0.0 to 999.9		40.0	
Proportional Band (Cooling)	<i>I-P</i>	Temperature input: 0.1 to 999.9		8.0	°C or °F
		Analog input: 0.1 to 999.9		10.0	%FS
Integral Time (Cooling)	<i>I-I</i>	Integral/Derivative Time Unit of 1 s: 0 to 9,999		233	Seconds
		Integral/Derivative Time Unit of 0.1 s: 0.0 to 999.9		233.0	
Derivative Time (Cooling)	<i>I-d</i>	Integral/Derivative Time Unit of 1 s: 0 to 9,999		40	Seconds
		Integral/Derivative Time Unit of 0.1 s: 0.0 to 999.9		40.0	
Dead Band	<i>I-db</i>	Temperature input: -199.9 to 999.9		0.0	°C or °F
		Analog input: -19.99 to 99.99		0.00	%FS
Manual Reset Value	<i>OF-R</i>	0.0 to 100.0		50.0	%
Hysteresis (Heating)	<i>HY5</i>	Temperature input: 0.1 to 999.9		1.0	°C or °F
		Analog input: 0.01 to 99.99		0.10	%FS
Hysteresis (Cooling)	<i>IHY5</i>	Temperature input: 0.1 to 999.9		1.0	°C or °F
		Analog input: 0.01 to 99.99		0.10	%FS

Parameters	Characters	Setting (monitor) value	Display	Default	Unit
Soak Time	<i>SORR</i>	1 to 9999		1	min or h
Wait Band	<i>WE-b</i>	Temperature input: OFF or 0.1 to 999.9	<i>OFF, 0.1 to 999.9</i>	OFF	°C or °F
		Analog input: OFF, 0.01 to 99.99	<i>OFF, 0.01 to 99.99</i>	OFF	%FS
MV at Stop	<i>MV-S</i>	Standard: -5.0 to 105.0 Heating/cooling: -105.0 to 105.0		0.0	%
MV at PV Error	<i>MV-E</i>	Standard: -5.0 to 105.0 Heating/cooling: -105.0 to 105.0		0.0	%
SP Ramp Set Value	<i>SPRL</i>	OFF, 1 to 9,999	<i>OFF, 1 to 9999</i>	OFF	EU/s, EU/min, EU/h
SP Ramp Fall Value	<i>SPRL</i>	SAME, OFF, or 1 to 9,999	<i>SAME, OFF, 1 to 9999</i>	SAME	EU/s, EU/min, EU/h
MV Upper Limit	<i>UL-H</i>	MV lower limit +0.1 to 105.0 (standard) 0.0 to 105.0 (heating/cooling)		100.0	%
MV Lower Limit	<i>UL-L</i>	-5.0 to MV upper limit -0.1 (standard) -105.0 to 0.0 (heating/cooling)		0.0 (standard) -100.0 (heating/ cooling)	%
MV Change Rate Limit	<i>CRL</i>	0.0 to 100.0 (0.0: MV Change Rate Limit Disabled)		0.0	%/s
Extraction of Square Root Low-cut Point	<i>SRP</i>	0.0 to 100.0		0.0	%

A-6-3 Initial Setting Level

Parameters	Characters	Setting (monitor) value	Display	Default	Unit	
Input Type	<i>IN-t</i>	Temperature input	0: Pt100 1: Pt100 2: Pt100 3: JPt100 4: JPt100 5: K 6: K 7: J 8: J 9: T 10: T 11: E 12: L 13: U 14: U 15: N 16: R 17: S 18: B 19: W 20: PLII 21: 10 to 70°C 22: 60 to 120°C 23: 115 to 165°C 24: 140 to 260°C		5	None
		Analog input	25: 4 to 20 mA 26: 0 to 20 mA 27: 1 to 5 V 28: 0 to 5 V 29: 0 to 10 V		5	None
Scaling Upper Limit	<i>IN-H</i>	Scaling lower limit + 1 to 9,999		100	None	
Scaling Lower Limit	<i>IN-L</i>	-1,999 to scaling upper limit -1		0	None	
Decimal Point	<i>dP</i>	0 to 3		0	None	

Parameters	Characters	Setting (monitor) value	Display	Default	Unit
Temperature Unit	<i>d-U</i>	°C, °F	<i>℄, F</i>	°C	None
SP Upper Limit	<i>SL-H</i>	Temperature input: SP lower limit + 1 to Input setting range upper limit		1300	EU
		Analog input: SP lower limit + 1 to scaling upper limit		100	
SP Lower Limit	<i>SL-L</i>	Temperature input: Input setting range lower limit to SP upper limit – 1		–200	EU
		Analog input: Scaling lower limit to SP upper limit – 1		0	
PID ON/OFF	<i>ENEL</i>	ON/OFF 2-PID	<i>āNāF, PĊd</i>	ON/OFF	None
Standard or Heating/Cooling	<i>S-HĊ</i>	Standard or heating/cooling	<i>SċNd, H-Ċ</i>	Standard	None
ST	<i>St</i>	OFF, ON	<i>āFF, āN</i>	ON	None
Program Pattern	<i>PERN</i>	OFF, STOP, CONT	<i>āFF, StāP, ĊāNċ</i>	OFF	None
Control Period (Heating)	<i>ĊP</i>	0.1, 0.2, 0.5, or 1 to 99	<i>0.1, 0.2, 0.5, 1 to 99</i>	Relay output: 20 Voltage output (for driving SSR): 2	Seconds
Control Period (Cooling)	<i>Ċ-ĊP</i>	0.1, 0.2, 0.5, or 1 to 99	<i>0.1, 0.2, 0.5, 1 to 99</i>	Relay output: 20 Voltage output (for driving SSR): 2	Seconds
Direct/Reverse Operation	<i>āREV</i>	Reverse operation, direct operation	<i>āR-R, āR-d</i>	Reverse operation	None
Alarm 1 Type	<i>RLċ1</i>	0: Alarm function OFF 1: Upper and lower-limit alarm 2: Upper-limit alarm 3: Lower-limit alarm 4: Upper and lower-limit range alarm 5: Upper- and lower-limit alarm with standby sequence 6: Upper-limit alarm with standby sequence 7: Lower-limit alarm with standby sequence 8: Absolute-value upper-limit alarm 9: Absolute-value lower-limit alarm 10: Absolute-value upper-limit alarm with standby sequence 11: Absolute-value lower-limit alarm with standby sequence 12: LBA (Loop Burnout Alarm) 13: PV change rate alarm 14: SP absolute-value upper-limit alarm 15: SP absolute-value lower-limit alarm 16: MV absolute-value upper-limit alarm 17: MV absolute-value lower-limit alarm 18: RSP absolute-value upper-limit alarm *1 19: RSP absolute-value lower-limit alarm *1		2	None
Alarm 1 Hysteresis	<i>RLH1</i>	Temperature input: 0.1 to 999.9 for all alarms except for MV absolute-value upper-limit or MV lower-limit alarms		0.2	°C or °F
		Analog input: 0.01 to 99.99 for all alarms except for MV absolute-value upper-limit or MV lower-limit alarms		0.02	%FS
		0.01 to 99.99 for MV absolute-value upper-limit or MV lower-limit alarms		0.50	%
Alarm 2 Type	<i>RLċ2</i>	Same as Alarm 1 Type except that 12 (LBA) cannot be set.		2	None

Parameters	Characters	Setting (monitor) value	Display	Default	Unit
Alarm 2 Hysteresis	RLH2	Temperature input: 0.1 to 999.9 for all alarms except for MV absolute-value upper-limit or MV lower-limit alarms		0.2	°C or °F
		Analog input: 0.01 to 99.99 for all alarms except for MV absolute-value upper-limit or MV lower-limit alarms		0.02	%FS
		0.01 to 99.99 for MV absolute-value upper-limit or MV lower-limit alarms		0.50	%
Alarm 3 Type	RLH3	Same as Alarm 1 Type except that 12 (LBA) cannot be set.		2	None
Alarm 3 Hysteresis	RLH3	Temperature input: 0.1 to 999.9 for all alarms except for MV absolute-value upper-limit or MV lower-limit alarms		0.2	°C or °F
		Analog input: 0.01 to 99.99 for all alarms except for MV absolute-value upper-limit or MV lower-limit alarms		0.02	%FS
		0.01 to 99.99 for MV absolute-value upper-limit or MV lower-limit alarms		0.50	%
Alarm 4 Type	RLH4	Same as Alarm 1 Type except that 12 (LBA) cannot be set.		2	None
Alarm 4 Hysteresis	RLH4	Temperature input: 0.1 to 999.9 for all alarms except for MV absolute-value upper-limit or MV lower-limit alarms		0.2	°C or °F
		Analog input: 0.01 to 99.99 for all alarms except for MV absolute-value upper-limit or MV lower-limit alarms		0.02	%FS
		0.01 to 99.99 for MV absolute-value upper-limit or MV lower-limit alarms		0.50	%
Control Output 1 Signal	o15t	4-20: 4-20 mA 0-20: 0-20 mA	4-20, 0-20	4-20	None
Control Output 2 Signal	o25t	4-20: 4-20 mA 0-20: 0-20 mA	4-20, 0-20	4-20	None
Transfer Output Signal	tR5t	4-20: 4-20 mA 1-5V: 1-5 V	4-20, 1-5V	4-20	None
Transfer Output Type	tR-t	OFF: OFF SP: Set point* ² SP-M: Ramp set point PV: Process value MV: Manipulated variable (heating) C-MV: Manipulated variable (cooling)* ³	oFF SP SP-M PV MV [-MV	OFF	None
Transfer Output Upper Limit	tR-H	*4		*4	*4
Transfer Output Lower Limit	tR-L	*4		*4	*4
Event Input Assignment 1	EV-1	NONE: None STOP: RUN/STOP MANU: Auto/Manual Switch PRST: Program Start * ⁵ DRS: Invert Direct/Reverse Operation RSP: SP mode switch* ¹ AT-2: 100% AT Execute/Cancel AT-1: 40% AT Execute/Cancel * ⁶ WTPT: Setting Change Enable/Disable CMWT: Communications write enable/disable* ⁷ LAT: Alarm Latch Cancel MSP0: Multi-SP No. switching bit 0 MSP1: Multi-SP No. switching bit 1 MSP2: Multi-SP No. switching bit 2	NONE StoP MANU PRSt dRS RSP Rt-2 Rt-1 WtPt [MwL LAt MSP0 MSP1 MSP2	MSP0	None
Event Input Assignment 2	EV-2	Same as Event Input Assignment 1.	Same as Event Input Assignment 1.	STOP	None

Parameters	Characters	Setting (monitor) value	Display	Default	Unit
Event Input Assignment 3	EV-3	Same as Event Input Assignment 1.	Same as Event Input Assignment 1.	NONE	None
Event Input Assignment 4	EV-4	Same as Event Input Assignment 1.	Same as Event Input Assignment 1.	NONE	None
Event Input Assignment 5	EV-5	Same as Event Input Assignment 1.	Same as Event Input Assignment 1.	NONE	None
Event Input Assignment 6	EV-6	Same as Event Input Assignment 1.	Same as Event Input Assignment 1.	NONE	None
Extraction of Square Root Enable	SR	OFF: ON	OFF, ON	OFF(0)	None
Move to Advanced function Setting Level	RMdV	-1,999 to 9,999		0	None

- *1 This function can be set only for a Controller that supports a remote SP input.
- *2 When the SP is selected, the remote SP will be output while the Remote SP Mode is set in the SP Mode parameter.
- *3 This value can be set for standard control, but the value will be disabled.
- *4

Transfer output type	Setting (monitor) range	Default*4.1 (transfer output upper/lower limits)	Unit
Set Point	SP lower limit to SP upper limit	SP upper limit/lower limit	EU
Set Point During SP Ramp	SP lower limit to SP upper limit	SP upper limit/lower limit	EU
PV	Temperature input: Input setting range lower limit to Input setting range upper limit	Input setting range upper/lower limit	EU
	Analog input: Scaling lower limit to Scaling upper limit	Scaling upper/lower limit	
MV (Heating)	Standard: -5.0 to 105.0 Heating/cooling: 0.0 to 105.0	100.0/0.0	%
MV (Cooling)	0.0 to 105.0	100.0/0.0	%

- *4.1 Initialized when the transfer output type is changed.
Initialized if the input type, temperature unit, scaling upper/lower limit, or SP upper/lower limit is changed when the transfer output type is SP, ramp SP, or PV.
(When initialized by the initializing settings, it is initialized to 100.0/0.0.)
- *5 PRST (Program Start) can be set even when the Program Pattern parameter is set to OFF, but the function will be disabled.
- *6 This function can be set for heating/cooling control, but the function will be disabled.
- *7 These settings can be used only for models with communications.

A-6-4 Manual Control Level

Parameters	Characters	Setting (monitor) value	Display	Default	Unit
Manual MV		-5.0 to 105.0 (standard)* -105.0 to 105.0 (heating/cooling)*		0.0	%

* When the Manual MV Limit Enable parameter is set to ON, the setting range will be the MV lower limit to the MV upper limit.

A-6-5 Monitor/Setting Item Level

The contents displayed vary depending on the Monitor/Setting 1 to 5 (advanced function setting level) setting.

A-6-6 Advanced Function Setting Level

Parameters	Characters	Setting (monitor) value	Display	Default	Unit
Parameter Initialization	$\bar{C}N\bar{C}t$	OFF, FACT	$\bar{a}FF, FRCt$	OFF	None
Number of Multi-SP Points	$MSPU$	OFF(1), 2 to 8	$\bar{a}FF, 2\ to\ 8$	OFF	None
SP Ramp Time Unit	$SPRU$	S: EU/second M: EU/minute H: EU/hour	S, M, H	M	None
Standby Sequence Reset	$RES\bar{t}$	Condition A, condition B	R, b	Condition A	None
Auxiliary Output 1 Open in Alarm	$5b\ iN$	N-O: Close in alarm N-C: Open in alarm	$N-\bar{a}, N-\bar{C}$	N-O	None
Auxiliary Output 2 Open in Alarm	$5b2N$	N-O: Close in alarm N-C: Open in alarm	$N-\bar{a}, N-\bar{C}$	N-O	None
Auxiliary Output 3 Open in Alarm	$5b3N$	N-O: Close in alarm N-C: Open in alarm	$N-\bar{a}, N-\bar{C}$	N-O	None
Auxiliary Output 4 Open in Alarm	$5b4N$	N-O: Close in alarm N-C: Open in alarm	$N-\bar{a}, N-\bar{C}$	N-O	None
HB ON/OFF	HbU	OFF, ON	$\bar{a}FF, \bar{a}N$	ON	None
Heater Burnout Latch	HbL	OFF, ON	$\bar{a}FF, \bar{a}N$	OFF	None
Heater Burnout Hysteresis	HbH	0.1 to 50.0		0.1	A
ST Stable Range	$St - b$	0.1 to 999.9		15.0	°C or °F
α	$ALFR$	0.00 to 1.00		0.65	None
Integral/Derivative Time Unit	$t\bar{C}DU$	1, 0.1	$1, 0.1$	1	Second
AT Calculated Gain	$AL - G$	0.1 to 10.0		0.8	None
AT Hysteresis	$AL - H$	Temperature input: 0.1 to 999.9		0.8	°C or °F
		Analog input: 0.01 to 9.99		0.20	%FS
Limit Cycle MV Amplitude	$LCMA$	5.0 to 50.0		20.0	%
Input Digital Filter	$\bar{C}NF$	0.0 to 999.9		0.0	Second
Moving Average Count	$MARV$	OFF, 2, 4, 8, 16, or 32		OFF	Times
MV Display	$\bar{a} - dP$	OFF, ON	$\bar{a}FF, \bar{a}N$	OFF	None
Automatic Display Return Time	RET	OFF, 1 to 99	$\bar{a}FF, 1\ to\ 99$	OFF	Second
Display Brightness	$bRG\bar{t}$	1 to 3		3	None
Alarm 1 Latch	$R1L\bar{t}$	OFF, ON	$\bar{a}FF, \bar{a}N$	OFF	None
Alarm 2 Latch	$R2L\bar{t}$	OFF, ON	$\bar{a}FF, \bar{a}N$	OFF	None
Alarm 3 Latch	$R3L\bar{t}$	OFF, ON	$\bar{a}FF, \bar{a}N$	OFF	None
Alarm 4 Latch	$R4L\bar{t}$	OFF, ON	$\bar{a}FF, \bar{a}N$	OFF	None
Move to Protect Level Time	$PRL\bar{t}$	1 to 30		3	Second
Cold Junction Compensation Method	CJC	OFF, ON	$\bar{a}FF, \bar{a}N$	ON	None
Alarm 1 ON Delay	$R1\bar{a}N$	0 to 999 (0: ON delay disabled)		0	Second
Alarm 2 ON Delay	$R2\bar{a}N$	0 to 999 (0: ON delay disabled)		0	Second
Alarm 3 ON Delay	$R3\bar{a}N$	0 to 999 (0: ON delay disabled)		0	Second
Alarm 4 ON Delay	$R4\bar{a}N$	0 to 999 (0: ON delay disabled)		0	Second
Alarm 1 OFF Delay	$R1\bar{a}F$	0 to 999 (0: OFF delay disabled)		0	Second
Alarm 2 OFF Delay	$R2\bar{a}F$	0 to 999 (0: OFF delay disabled)		0	Second
Alarm 3 OFF Delay	$R3\bar{a}F$	0 to 999 (0: OFF delay disabled)		0	Second
Alarm 4 OFF Delay	$R4\bar{a}F$	0 to 999 (0: OFF delay disabled)		0	Second
MV at Stop and Error Addition	$MVSE$	OFF, ON	$\bar{a}FF, \bar{a}N$	OFF	None
Auto/Manual Select Addition	$AMRd$	OFF, ON	$\bar{a}FF, \bar{a}N$	OFF	None
Manual Output Method	$MAR\bar{N}t$	HOLD or INIT	$H\bar{a}Ld, \bar{C}N\bar{C}t$	HOLD	None

Parameters	Characters	Setting (monitor) value	Display	Default	Unit
Manual MV Initial Value	<i>MANN</i>	-5.0 to 105.0 for standard control *1 -105.0 to 105.0 for heating/cooling control *1		0.0	%
RT	<i>RL</i>	OFF, ON	<i>OFF, ON</i>	OFF	None
HS Alarm Use	<i>HSU</i>	OFF, ON	<i>OFF, ON</i>	ON	None
HS Alarm Latch	<i>HSL</i>	OFF, ON	<i>OFF, ON</i>	OFF	None
HS Alarm Hysteresis	<i>HSH</i>	0.1 to 50.0		0.1	A
LBA Detection Time	<i>LbR</i>	0 to 9999 (0: LBA function disabled)		0	Second
LBA Level	<i>LbRL</i>	Temperature input: 0.1 to 999.9 Analog input: 0.01 to 99.99		8.0 10.00	°C or °F %FS
LBA Band	<i>LbRb</i>	Temperature input: 0.0 to 999.9 Analog input: 0.00 to 99.99		3.0 0.20	°C or °F %FS
Control Output 1 Assignment	<i>OUT 1</i>	Relay Output or Voltage Output (for Driving SSR) *2 NONE: No assignment O: Control output (heating) C-O: Control output (cooling) ALM1: Alarm 1 ALM2: Alarm 2 ALM3: Alarm 3 ALM4: Alarm 4 HA: Heater alarm (HB + HS) HB: Heater burnout alarm (HB) HS: Heater short alarm (HS) S.ERR: Input error RS.ER: Remote SP input error P.END: Program End output *3 RUN: RUN output ALM: Integrated alarm WR1: Work bit 1 *4 WR2: Work bit 2 *4 WR3: Work bit 3 *4 WR4: Work bit 4 *4 WR5: Work bit 5 *4 WR6: Work bit 6 *4 WR7: Work bit 7 *4 WR8: Work bit 8 *4 Current Output *2 NONE: Not assigned. O: Control output (heating) C-O: Control output (cooling)	<i>NONE</i> <i>O</i> <i>C-O</i> <i>ALM1</i> <i>ALM2</i> <i>ALM3</i> <i>ALM4</i> <i>HA</i> <i>HB</i> <i>HS</i> <i>S.ERR</i> <i>RS.ER</i> <i>P.END</i> <i>RUN</i> <i>ALM</i> <i>WR1</i> <i>WR2</i> <i>WR3</i> <i>WR4</i> <i>WR5</i> <i>WR6</i> <i>WR7</i> <i>WR8</i> <i>NONE</i> <i>O</i> <i>C-O</i>	O	None
Control Output 2 Assignment	<i>OUT 2</i>	Same as the Control Output 1 Assignment parameter.	Same as the Control Output 1 Assignment parameter.	NONE	None

Parameters	Characters	Setting (monitor) value	Display	Default	Unit
Auxiliary Output 1 Assignment	<i>Sub 1</i>	NONE: No assignment O: Control output (heating) C-O: Control output (cooling) ALM1: Alarm 1 ALM2: Alarm 2 ALM3: Alarm 3 ALM4: Alarm 4 HA: Heater alarm (HB + HS) HB: Heater burnout alarm (HB) HS: Heater short alarm (HS) S.ERR: Input error RS.ER: RSP input error P.END: Program end output *3 RUN: RUN output ALM: Integrated alarm WR1: Work bit 1 *4 WR2: Work bit 2 *4 WR3: Work bit 3 *4 WR4: Work bit 4 *4 WR5: Work bit 5 *4 WR6: Work bit 6 *4 WR7: Work bit 7 *4 WR8: Work bit 8 *4	<i>NONE</i> <i>o</i> <i>C-o</i> <i>ALM 1</i> <i>ALM 2</i> <i>ALM 3</i> <i>ALM 4</i> <i>HA</i> <i>HB</i> <i>HS</i> <i>S.ERR</i> <i>RS.ER</i> <i>P.END</i> <i>RUN</i> <i>ALM</i> <i>WR 1</i> <i>WR 2</i> <i>WR 3</i> <i>WR 4</i> <i>WR 5</i> <i>WR 6</i> <i>WR 7</i> <i>WR 8</i>	ALM1 *Controllers without HB and HS alarm detection: HA	None
Auxiliary Output 2 Assignment	<i>Sub 2</i>	Same as the Auxiliary Output 1 Assignment parameter.	Same as the Auxiliary Output 1 Assignment parameter.	ALM2	None
Auxiliary Output 3 Assignment	<i>Sub 3</i>	Same as the Auxiliary Output 1 Assignment parameter.	Same as the Auxiliary Output 1 Assignment parameter.	ALM3	None
Auxiliary Output 4 Assignment	<i>Sub 4</i>	Same as the Auxiliary Output 1 Assignment parameter.	Same as the Auxiliary Output 1 Assignment parameter.	ALM4	None
Integrated Alarm Assignment	<i>ALM A</i>	0 to 255 Alarm 1: +1 Alarm 2: +2 Alarm 3: +4 Alarm 4: +8 HB alarm: +16 HS alarm: +32 Input error: +64 RSP input error: +128		49	None
Soak Time Unit	<i>t-U</i>	M: Minutes H: Hours	<i>M, H</i>	M	None
Alarm SP Selection	<i>AL SP</i>	SP-M: Ramp set point SP: Set point	<i>SP-M, SP</i>	SP-M	None
Remote SP Input	<i>RS-t</i>	4-20: 4-20 mA 0-20: 0-20 mA 1-5V: 1-5 V 0-5V: 0-5 V 0-10: 0-10 V	<i>4-20, 0-20, 1-5V, 0-5V, 0-10</i>	4-20	None
Remote SP Enable	<i>RSPU</i>	OFF, ON	<i>oFF, oN</i>	OFF	None
Remote SP Upper limit	<i>RSPH</i>	Temperature input: Input setting range lower limit to Input setting range upper limit		1300	EU
		Analog input: Scaling lower limit to Scaling upper limit		100	

Parameters	Characters	Setting (monitor) value	Display	Default	Unit
Remote SP lower limit	RSPL	Temperature input: Input setting range lower limit to Input setting range upper limit		-200	EU
		Analog input: Scaling lower limit to Scaling upper limit		0	
SP Tracking	SPTR	OFF, ON	OFF, ON	OFF	None
Manual MV Limit Enable	MANL	OFF, ON	OFF, ON	OFF	None
PV Rate of Change Calculation Period	PVRC	1 to 999		20	Sampling period
Heating/Cooling Tuning Method	HCLM	0: Same as heating control 1: Linear 2: Air cooling 3: Water cooling		0	None
Minimum Output ON/OFF Band	AMPW	0.0 to 50.0		1.0	%
PF Setting	PF	OFF: OFF RUN: RUN STOP: STOP R-S: RUN/STOP AT-2: 100% AT execute/cancel AT-1: 40% AT execute/cancel LAT: Alarm Latch Cancel A-M: Auto/manual PFDP: Monitor/setting item SHFT: Digit Shift Key	OFF RUN STOP R-S AT-2 AT-1 LAT A-M PFDP SHFT	SHFT	None
Monitor/Setting Item 1	PFd1	0: Disabled 1: PV/SP/Multi-SP 2: PV/SP/MV 3: PV/SP/Soak time remain 4: Proportional band (P) 5: Integral time (I) 6: Derivative time (D) 7: Alarm value 1 8: Alarm value upper limit 1 9: Alarm value lower limit 1 10: Alarm value 2 11: Alarm value upper limit 2 12: Alarm value lower limit 2 13: Alarm value 3 14: Alarm value upper limit 3 15: Alarm value lower limit 3 16: Alarm value 4 17: Alarm value upper limit 4 18: Alarm value lower limit 4 19: PV/SP/Internal SP 20: PV/SP/Alarm value 1 21: Proportional Band (Cooling) (C-P) 22: Integral Time (Cooling) (C-I) 23: Derivative Time (Cooling) (C-D)		1	None
Monitor/Setting Item 2	PFd2	Same as Monitor/Setting Item 1.		0	None
Monitor/Setting Item 3	PFd3	Same as Monitor/Setting Item 1.		0	None
Monitor/Setting Item 4	PFd4	Same as Monitor/Setting Item 1.		0	None
Monitor/Setting Item 5	PFd5	Same as Monitor/Setting Item 1.		0	None
PV/SP No. 1 Display Selection	SPd1	0: Nothing is displayed. 1: PV/SP/Nothing displayed 2: PV/Nothing displayed/Nothing displayed 3: SP/SP (character display)/Nothing displayed 4: PV/SP/MV 5: PV/SP/Multi-SP No. 6: PV/SP/Soak time remain 7: PV/SP/Internal SP (ramp SP) 8: PV/SP/Alarm value 1		4	None
PV/SP No. 2 Display Selection	SPd2	Same as PV/SP No. 1 Display Selection.		0	None
MV Display Selection	ad5L	0: MV (Heating) C-O: MV (Cooling)	0, L - 0	0	None

Parameters	Characters	Setting (monitor) value	Display	Default	Unit
PV Decimal Point Display	PVdP	OFF, ON	OFF, ON	ON	None
PV Status Display Function	PVSt	OFF: OFF MANU: Manual STOP: Stop ALM1: Alarm 1 ALM2: Alarm 2 ALM3: Alarm 3 ALM4: Alarm 4 ALM: OR of alarms 1 to 4 HA: Heater alarm	OFF MANU STOP ALM1 ALM2 ALM3 ALM4 ALM HA	OFF	None
SV Status Display Function	SVSt	OFF: OFF MANU: Manual STOP: Stop ALM1: Alarm 1 ALM2: Alarm 2 ALM3: Alarm 3 ALM4: Alarm 4 ALM: OR of alarms 1 to 4 HA: Heater alarm	OFF MANU STOP ALM1 ALM2 ALM3 ALM4 ALM HA	OFF	None
Display Refresh Period	dREF	OFF, 0.25, 0.5, 1.0	OFF, 0.25, 0.5, 1.0	0.25	Second
Move to Calibration Level	EMOV	-1999 to 9999		0	None

- *1 If the Manual MV Limit Enable parameter is set to ON, the setting range will be the MV lower limit to the MV upper limit.
- *2 The setting ranges are different for relay and voltage outputs (for driving SSR) and for current outputs.
- *3 This parameter can be set when the Program Pattern parameter is set to OFF, but the function will be disabled.
- *4 WR1 to WR8 are not displayed when the logic operation function is not used.

A-6-7 Protect Level

Parameters	Characters	Setting (monitor) value	Display	Default	Unit
Move to Protect level	PMOV	-1999 to 9999		0	None
Operation/Adjustment Protect	OPPE	0 to 3		0	None
Initial Setting/Communications Protect	ICPE	0 to 2		1	None
Setting Change Protect	WPEP	OFF, ON	OFF, ON	OFF	None
PF Key Protect	PFPPE	OFF, ON	OFF, ON	OFF	None
Changed Parameters Only	CHGP	OFF, ON	OFF, ON	OFF	None
Parameter Mask Enable	PMSK	OFF, ON	OFF, ON	ON	None
Password to Move to Protect Level	PRLP	-1,999 to 9,999		0	None

A-6-8 Communications Setting Level

Parameters	Characters	Setting (monitor) value	Display	Default	Unit
Protocol Setting	PSEL	CWF: CompoWay/F MOD: Modbus	CWF, Mod	CompoWay/ F	None
Communications Unit No.	U-No	0 to 99		1	None
Communications Baud Rate	bPS	9.6, 19.2, 38.4, or 57.6	9.6, 9.2, 38.4, 57.6	9.6	kbps
Communications Data Length	LEN	7, 8		7	Bit
Communications Stop Bits	SbL	1, 2		2	Bit
Communications Parity	PRLY	NONE: None EVEN: Even ODD: Odd	NONE, EVEN, odd	Even	None
Send Data Wait Time	SdWT	0 to 99		20	ms

A-6-9 Initialization According to Parameter Changes

The parameters that are initialized when parameters are changed are shown under Related initialized parameters.

Changed parameter	Input Type	Temperature Unit	Scaling Lower Limit Scaling Upper Limit	SP Lower Limit SP Upper Limit	PID ON/OFF	Standard or Heating/Cooling	Program Pattern	ST	Remote SP Enable	Transfer Output Type	RT	Integral/Derivative Time Unit	Alarm 1 to 4 Type	SP 0 to 7 Set Point	Password to Move to Protect Level
Related parameter initialization execution condition		Temperature input	Analog input								*9				
SP Upper Limit SP Lower Limit	●*1	●*1	●*1	---	---	---	---	---	---	---	---	---	---	---	---
Set Point	●*2	●*2	●*2	●*2	---	---	---	---	---	---	---	---	---	●*16	---
SP0 to SP7	●*2	●*2	●*2	●*2	---	---	---	---	---	---	---	---	---	●*16	---
RT	●*3	---	---	---	---	---	---	---	---	---	---	---	---	---	---
Proportional Band	●*13	---	---	---	---	---	---	---	---	---	●*9	●*19	---	---	---
Integral Time	●*13	---	---	---	---	---	---	---	---	---	●*9	●*19	---	---	---
Derivative Time	●*13	---	---	---	---	---	---	---	---	---	●*9	●*19	---	---	---
Proportional Band (Cooling)	●*13	---	---	---	---	---	---	---	---	---	●*9	●*19	---	---	---
Integral Time (Cooling)	●*13	---	---	---	---	---	---	---	---	---	●*9	●*19	---	---	---
Derivative Time (Cooling)	●*13	---	---	---	---	---	---	---	---	---	●*9	●*19	---	---	---
Integral/Derivative Time Unit	---	---	---	---	---	---	---	---	---	---	●*9	---	---	---	---
MV Upper Limit, MV Lower Limit	---	---	---	---	---	●*5	---	---	---	---	---	---	---	---	---
MV at Stop	---	---	---	---	---	●	---	---	---	---	---	---	---	---	---
MV at PV Error	---	---	---	---	---	●	---	---	---	---	---	---	---	---	---
Transfer Output Upper Limit, Transfer Output Lower Limit *4	●*4.1	●*4.1	●*4.1	●*4.1	---	●*4.2	---	---	---	●*4.3	---	---	---	---	---
SP Mode	●*17	---	---	---	●*17	●*17	---	●*11	●*12	---	---	---	---	---	---
Remote SP Enable	●*17	---	---	---	●*17	●*17	---	●*11	---	---	---	---	---	---	---
Remote SP Upper Limit Remote SP Lower Limit	●*1	●*1	●*1	---	---	---	---	---	---	---	---	---	---	---	---
Control Output 1 Assignment	---	---	---	---	---	●	●	---	---	---	---	---	---	---	---
Control Output 2 Assignment	---	---	---	---	---	●*6	●*6	---	---	---	---	---	---	---	---
Auxiliary Output 1 Assignment	---	---	---	---	---	●*7	●*7	---	---	---	---	---	---	---	---
Auxiliary Output 2 Assignment	---	---	---	---	---	●*6	●*6	---	---	---	---	---	---	---	---
Auxiliary Output 3 Assignment	---	---	---	---	---	●	●	---	---	---	---	---	---	---	---
Auxiliary Output 4 Assignment	---	---	---	---	---	●*6	●*6	---	---	---	---	---	---	---	---
Event Input Assignment 1 to 6	---	---	---	---	---	---	●*8	---	---	---	---	---	---	---	---
Move to Protect Level	---	---	---	---	---	---	---	---	---	---	---	---	---	---	●*10
MV Display Selection	---	---	---	---	---	●	---	---	---	---	---	---	---	---	---

Changed parameter	Input Type	Temperature Unit	Scaling Lower Limit	Scaling Upper Limit	SP Lower Limit	SP Upper Limit	PID ON/OFF	Standard or Heating/Cooling	Program Pattern	ST	Remote SP Enable	Transfer Output Type	RT	Integral/Derivative Time Unit	Alarm 1 to 4 Type	SP 0 to 7 Set Point	Password to Move to Protect Level
Dead Band	●*13	---	---	---	---	---	---	---	---	---	---	---	---	---	---	---	---
Hysteresis (Heating)	●*13	---	---	---	---	---	---	---	---	---	---	---	---	---	---	---	---
Hysteresis (Cooling)	●*13	---	---	---	---	---	---	---	---	---	---	---	---	---	---	---	---
Wait Band	●*13	---	---	---	---	---	---	---	---	---	---	---	---	---	---	---	---
Alarm 1 to 4 Hysteresis	●*14	---	---	---	---	---	---	---	---	---	---	---	---	---	●*15	---	---
ST Stable Range	●*13	---	---	---	---	---	---	---	---	---	---	---	---	---	---	---	---
AT Hysteresis	●*13 *18	●*18	---	---	---	---	---	---	---	---	---	---	---	---	---	---	---
LBA Level	●*13	---	---	---	---	---	---	---	---	---	---	---	---	---	---	---	---
LBA Band	●*13	---	---	---	---	---	---	---	---	---	---	---	---	---	---	---	---

- *1 Initialized to input setting range upper and lower limits, or scaling upper and lower limits.
- *2 Clamped by SP upper and lower limits.
- *3 This parameter is initialized only when the input type is changed to analog input when the RT parameter is ON. The RT parameter turns OFF.
- *4 Initialization is performed as shown below according to the transfer output type setting. The initialization differs depending on the changed parameter and the output type setting.
 - SP: SP upper and lower limits
 - Ramp SP: SP upper and lower limits
 - PV: Input setting range upper and lower limits or scaling upper and lower limits
 - MV (Heating): 100.0/0.0
 - MV (Cooling): 100.0/0.0
 - *4.1 Initialized only when the transfer output type is set to SP, Ramp SP, or PV.
 - *4.2 Initialized only when the transfer output type is set to MV (Heating) or MV (Cooling).
 - *4.3 Initialized to the above default values regardless of the settings for changing the transfer output type.
- *5 Initialized as follows according to the Standard or Heating/Cooling parameter setting.
 - MV Upper Limit: 100.0
 - MV Lower Limit: Standard 0.0, heating/cooling -100.0
- *6 Initialized to control output (cooling) for heating and cooling control, according to the following. (The defaults for standard control are the defaults in the parameter list.)
 - With control output 2: The Control Output 2 Assignment parameter is initialized to control output (cooling).
 - If the Controller does not have control output 2 but has four auxiliary outputs, the Auxiliary Output 4 Assignment parameter is initialized to Control Output (Cooling).
 - Otherwise, the Auxiliary Output 2 Assignment parameter is initialized to Control Output (Cooling).
- *7 If the Program Pattern parameter is set to OFF, the Auxiliary Output 1 Assignment parameter is initialized as follows:
 - Controllers with HB and HS alarms: Heater alarm
 - Controllers without HB and HS alarms: Alarm 1
 If the Program Pattern parameter is not set to OFF, the Auxiliary Output 1 Assignment parameter is initialized to the program end output.
- *8 If the Program Start parameter is assigned when the program pattern is changed to OFF, the Program Start parameter will be initialized to "not assigned."
- *9 For a temperature input, the Integral/Derivative Time Unit parameter is initialized only when the RT parameter is turned ON. The default is as follows:
 - Integral/Derivative Time Unit: 0.1 s (The PID parameters are also initialized when the Integral/Derivative Time Unit parameter is initialized.) *19
- *10 This parameter is initialized to the new Password to Move to Protect Level password.
- *11 When the ST parameter is turned ON, the SP Mode parameter is initialized to LSP and the Remote SP Enable parameter is initialized to OFF.
- *12 When the Remote SP Enable parameter is turned OFF, the SP Mode parameter is initialized to LSP.

- *13 These parameters are initialized when the Input Type parameter is changed from a temperature input to an analog input or from an analog input to a temperature input.
- *14 This parameter is initialized when the Input Type parameter is changed from a temperature input to an analog input or from an analog input to a temperature input. However, it is not initialized if the applicable alarm is an MV absolute-value upper-limit alarm or an MV absolute-value lower-limit alarm.
- *15 This parameter is initialized to 50 (0.50%) if a non-MV alarm is changed to an MV alarm. This parameter is initialized to 2 (0.2°C or 0.02%FS) if an MV alarm is changed to a non-MV alarm.
- *16 Write to both so that the SP and the currently selected Multi-SP SP0 to SP7 match.
- *17 When the ST condition is met, the SP Mode parameter is initialized to LSP and the Remote SP Enable parameter is initialized to OFF.
- *18 Initialized to 0.8 when the temperature unit is °C, and to 1.4 when the temperature unit is °F.
- *19 These parameters are initialized as follows:
 - Integral/Derivative Time Unit of 1 s: Proportional band to 8.0, integral time to 233, and derivative time to 40. (This applies to both the heating and cooling constants.)
 - Integral/Derivative Time Unit of 0.1 s: Proportional band to 8.0, integral time to 233.0, and derivative time to 40.0. (This applies to both the heating and cooling constants.)

A-7 Sensor Input Setting Range, Indication Range, Control Range

	Specifications	Set value	Input setting range	Input indication range
Resistance thermometer	Pt100	0	-200 to 850 (°C)/-300 to 1500 (°F)	-220 to 870 (°C)/-340 to 1540 (°F)
		1	-199.9 to 500.0 (°C)/-199.9 to 900.0 (°F)	-199.9 to 520.0 (°C)/-199.9 to 940.0 (°F)
	JPt100	2	0.0 to 100.0 (°C)/0.0 to 210.0 (°F)	-20.0 to 120.0 (°C)/-40.0 to 250.0 (°F)
		3	-199.9 to 500.0 (°C)/-199.9 to 900.0 (°F)	-199.9 to 520.0 (°C)/-199.9 to 940.0 (°F)
Thermocouple	K	4	0.0 to 100.0 (°C)/0.0 to 210.0 (°F)	-20.0 to 120.0 (°C)/-40.0 to 250.0 (°F)
		5	-200 to 1300 (°C)/-300 to 2300 (°F)	-220 to 1320 (°C)/-340 to 2340 (°F)
	J	6	-20.0 to 500.0 (°C)/0.0 to 900.0 (°F)	-40.0 to 520.0 (°C)/-40.0 to 940.0 (°F)
		7	-100 to 850 (°C)/-100 to 1500 (°F)	-120 to 870 (°C)/-140 to 1540 (°F)
	T	8	-20.0 to 400.0 (°C)/0.0 to 750.0 (°F)	-40.0 to 420.0 (°C)/-40.0 to 790.0 (°F)
		9	-200 to 400 (°C)/-300 to 700 (°F)	-220 to 420 (°C)/-340 to 740 (°F)
	E	10	-199.9 to 400.0 (°C)/-199.9 to 700.0 (°F)	-199.9 to 420.0 (°C)/-199.9 to 740.0 (°F)
		11	-200 to 600 (°C)/-300 to 1100 (°F)	-220 to 620 (°C)/-340 to 1140 (°F)
	L	12	-100 to 850 (°C)/-100 to 1500 (°F)	-120 to 870 (°C)/-140 to 1540 (°F)
		13	-200 to 400 (°C)/-300 to 700 (°F)	-220 to 420 (°C)/-340 to 740 (°F)
	U	14	-199.9 to 400.0 (°C)/-199.9 to 700.0 (°F)	-199.9 to 420.0 (°C)/-199.9 to 740 (°F)
		15	-200 to 1300 (°C)/-300 to 2300 (°F)	-220 to 1320 (°C)/-340 to 2340 (°F)
	R	16	0 to 1700 (°C)/0 to 3000 (°F)	-20 to 1720 (°C)/-40 to 3040 (°F)
		17	0 to 1700 (°C)/0 to 3000 (°F)	-20 to 1720 (°C)/-40 to 3040 (°F)
	B	18	100 to 1800 (°C)/300 to 3200 (°F)	0 to 1820 (°C)/0 to 3240 (°F)
		19	0 to 2300 (°C)/0 to 3200 (°F)	-20 to 2320 (°C)/-40 to 3240 (°F)
PLII	20	0 to 1300 (°C)/0 to 2300 (°F)	-20 to 1320 (°C)/-40 to 2340 (°F)	
	ES1B Infrared Temperature Sensor	10 to 70°C	21	0 to 90 (°C)/0 to 190 (°F)
60 to 120°C		22	0 to 120 (°C)/0 to 240 (°F)	-20 to 160 (°C)/-40 to 320 (°F)
115 to 165°C		23	0 to 165 (°C)/0 to 320 (°F)	-20 to 205 (°C)/-40 to 400 (°F)
140 to 260°C		24	0 to 260 (°C)/0 to 500 (°F)	-20 to 300 (°C)/-40 to 580 (°F)
Current input	4 to 20 mA	25	Any of the following ranges, by scaling: -1999 to 9999 -199.9 to 999.9 -19.99 to 99.99 -1.999 to 9.999	-5% to 105% of setting range. The display shows -1999 to 9999 (numeric range with decimal point omitted).
	0 to 20 mA	26		
	Voltage input	1 to 5 V		
0 to 5 V		28		
0 to 10 V		29		

- The default is 5.
- The applicable standards for each of the above input ranges are as follows:
K, J, T, E, N, R, S, B: JIS C1602-1995, IEC 60584-1
L: Fe-CuNi, DIN 43710-1985
U: Cu-CuNi, DIN 43710-1985
W: W5Re/W26Re, ASTM E988-1990
JPt100: JIS C 1604-1989, JIS C 1606-1989
Pt100: JIS C 1604-1997, IEC 60751
PLII: According to Platinel II Electromotive Force Table by Engelhard Corp.

A-8 Setting Levels Diagram

This diagram shows all of the setting levels. To move to the Advanced Function Setting Level and Calibration Level, you must enter passwords. Some parameters are not displayed depending on the protect level setting and the conditions of use.

Control stops when you move from the Operation Level to the Initial Setting Level.

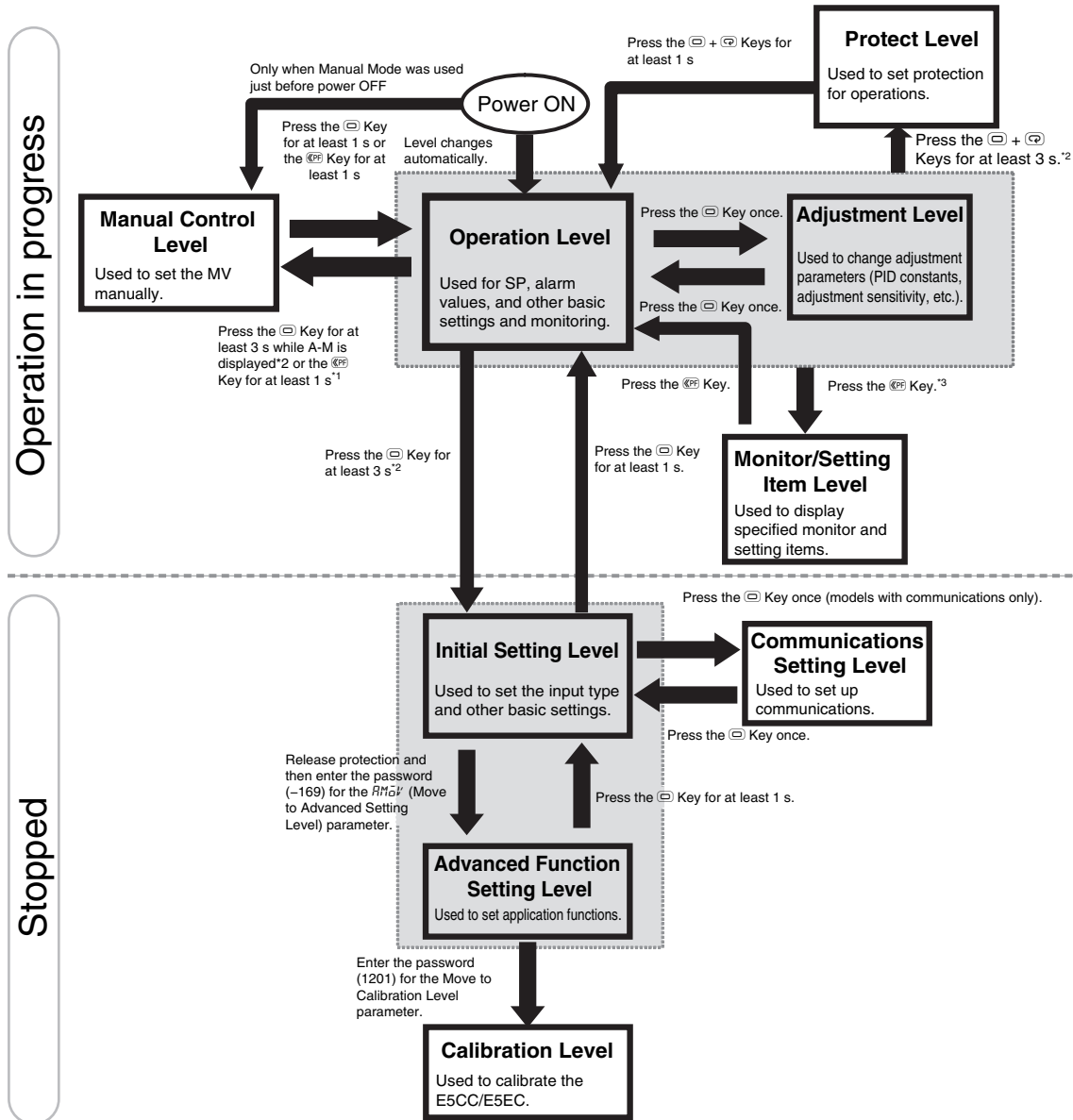

A-8 Setting Levels Diagram

A

- *1 To use a key procedure to move to Manual Control Level, set the Auto/Manual Select Addition parameter to ON and set the PF Setting parameter to R-M (Auto/Manual).
- *2 The No. 1 display will flash when the keys are pressed for 1 s or longer.
- *3 Set the PF Setting parameter to PFdP (monitor/setting items).

A-9 Parameter Flow

This section describes the parameters set in each level. Pressing the **⏪** Key at the last parameter in each level returns to the top parameter in that level.

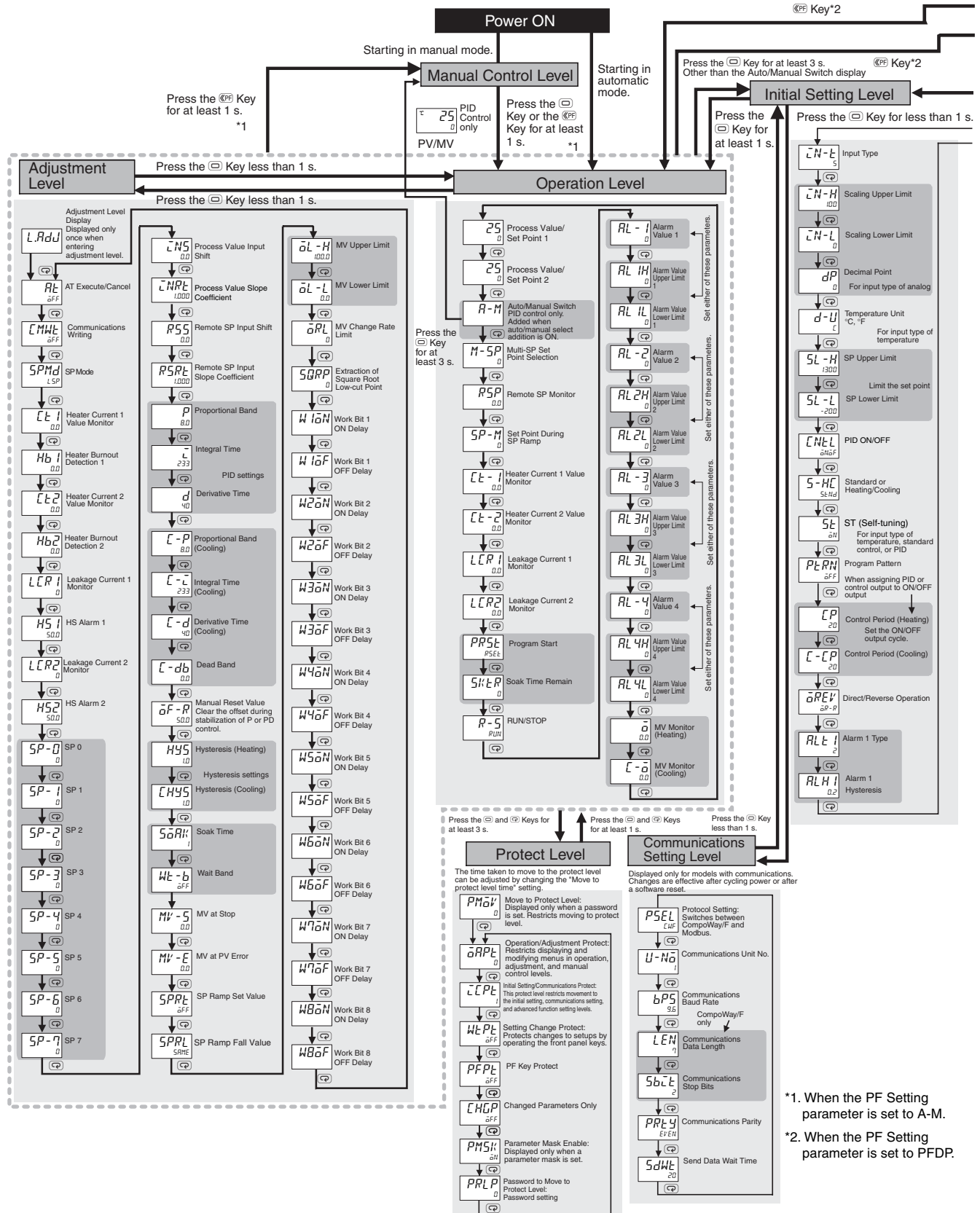

*1. When the PF Setting parameter is set to A-M.
 *2. When the PF Setting parameter is set to PFDP.

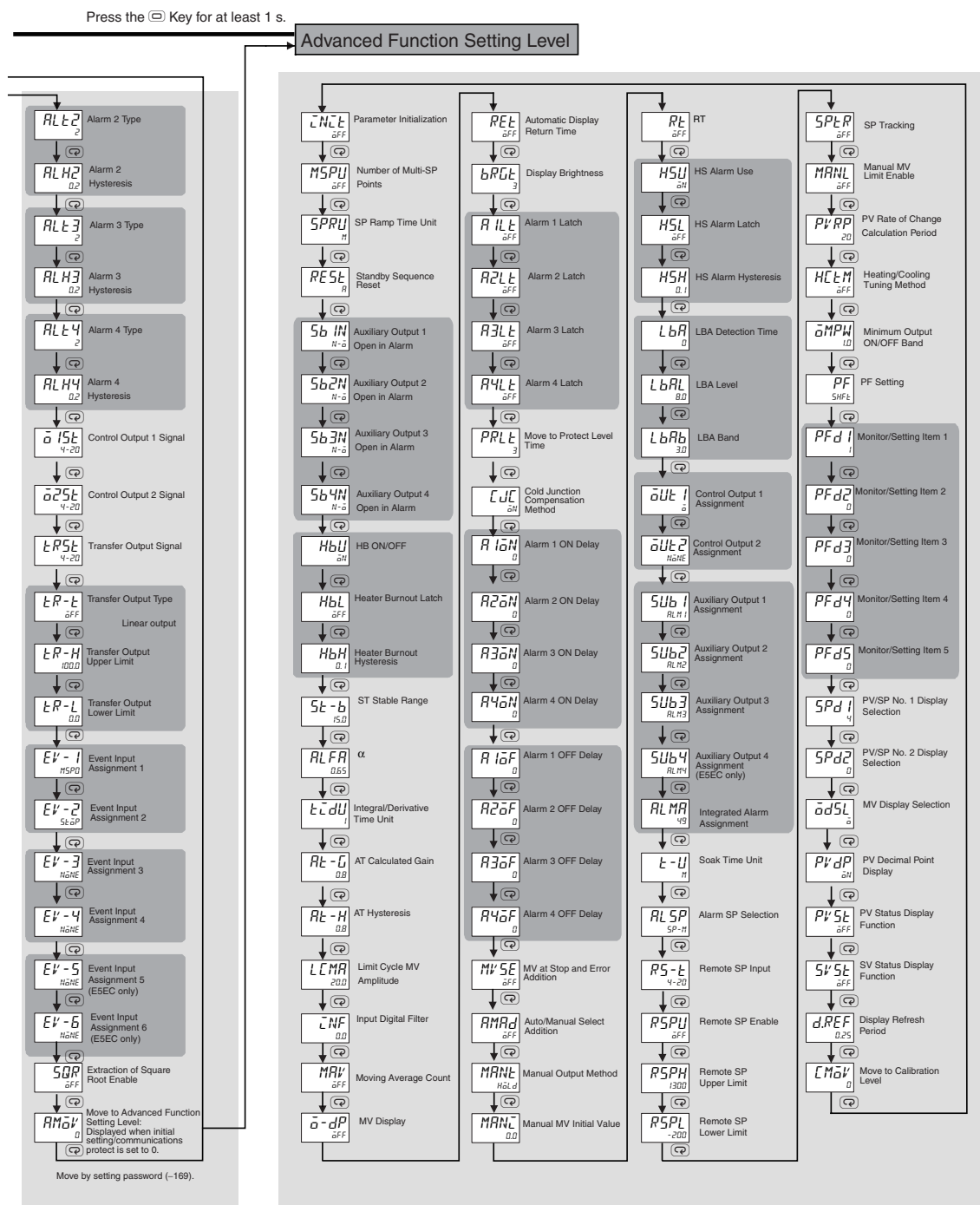
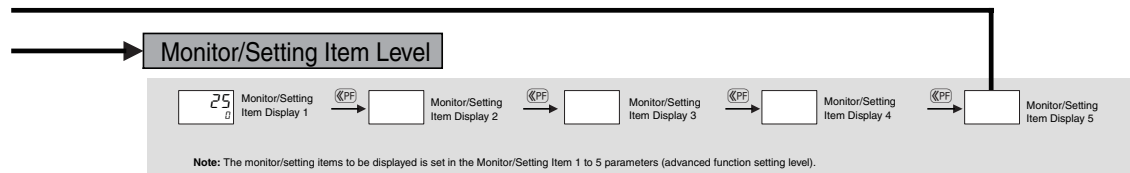

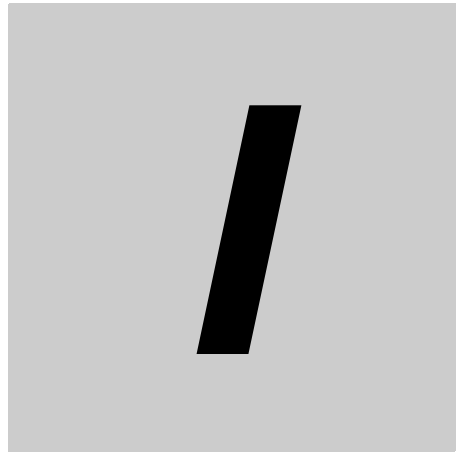

Index



Numerics

2-PID control 4-13, 6-41

A

AD Converter Error A-11
Adjustment Level 6-17, A-17
Advanced Function Setting Level 6-54, A-22
air cooling/water cooling tuning 5-9
alarm delays 5-26
alarm hysteresis 4-37
alarm latches 4-38
alarm operation 4-38
alarm outputs 4-30
alarm types 4-30
alarm values 4-34
alarms 4-16
alarms (standard alarms) 1-3
analog inputs 5-5, 7-9
assigning outputs 4-15
AT (auto-tuning) 4-23
auto/manual control 5-12
auto/manual selection display 5-32
auto-tuning (AT) 4-23, 6-19
auxiliary output opening and closing in alarm 4-18
auxiliary outputs 1 to 4 2-18

B

balanceless-bumpless operation 5-31

C

calibrating a current input 7-9
calibrating a voltage input 7-10
calibrating inputs 7-2
calibrating the transfer output 7-11
characteristics A-4
checking indication accuracy 7-13
 analog input 7-14
 infrared temperature sensor 7-13
 resistance thermometer 7-14
clearing the program end status 5-39
cold junction compensator 7-13
communications 2-21
communications operation command 5-21
Communications Setting Level 6-84, A-26
CompoWay/F 1-4, 5-53, 6-84, A-26
connecting the cold junction compensator 7-4
control outputs 1-3, 4-17
control outputs 1 and 2 2-17
control periods 4-14
control ranges A-30
controlling the start of the simple program function 5-13
CT
 dimensions A-7
 E54-CT1 A-7
 E54-CT3 A-7

 specifications A-7
CT inputs 2-19
current transformer (CT) 4-43, A-7
Current Value Exceeds A-12

D

derivative time 4-29
detection current values 4-45
Digit Shift Key 3-7
dimensions 2-2
direct and reverse operation 4-14
Display Range Exceeded A-11
displaying changed parameters 5-22
Down Key (☑ Key) 3-6

E

error displays A-10
event inputs 1-3, 2-18, 5-11
extraction of square roots 5-44

F

front panel 3-4
 E5CC 3-4
 E5EC 3-4

H

HB alarm 4-39, A-3, A-12
heater burnout alarm 6-58, A-3
heater short alarm 4-39, A-3
heating/cooling control 5-7, 6-42
HS alarm 4-41, A-3, A-12
HS alarms 1-3

I

I/O configuration 1-5
indication ranges A-30
infrared temperature sensor 7-13
initial setting example
 example 1 4-8
 example 2 4-9
initial setting examples 4-8
Initial Setting Level 3-4, 6-38, A-18
initialization 6-56
Input Error A-10
input error 6-31
input sensor types 1-3
Input Type
 default 6-39
input type 4-10
inputs 2-16
installation 2-2
 mounting the Terminal Covers
 E5CC 2-5
 E5EC 2-6

mounting to the panel	
E5CC	2-5
E5EC	2-6
insulation block diagrams	2-22
integral time	4-29
integral/derivative time unit	5-9

K

key operations	5-11
Keys	
⏏ Down Key	3-6
⏏ Level Key	3-6
⏏ Mode Key	3-6
⏏ Shift Key (PF Key)	3-6
⏏ Up Key	3-6

L

Level Key (⏏ Key)	3-6
linear tuning	5-9
logic operations	5-57
loop burnout alarm	5-28

M

main functions	1-3
manual control	5-31
Manual Control Level	6-36, A-21
manual output method	5-31
manual setup	4-28
Memory Error	A-12
Modbus-RTU	1-4, 5-53, A-26
Mode Key (⏏ Key)	3-6
model number legends	1-6
Monitor/Setting Item Level	6-35, A-21
mounting the Terminal Covers	
E5CC	2-5
E5EC	2-6
multi-SP	5-11

N

No. 1 display	3-4, 4-49, 6-8
No. 2 display	3-4, 4-49, 6-8
No. 3 display	3-4, 4-49, 6-8

O

ON/OFF control	4-13, 4-20, 6-41
operation indicators	3-4, 3-5
Operation Level	6-7, A-16
output limits	5-42
output periods	6-43

P

panel cutout	2-3
parameter flow	A-32

parameter operation lists	A-16
parameter structure	7-3
parameters	
α	6-60
Adjustment Level Display	6-19
Alarm 1 to 4 Hysteresis	6-48
Alarm 1 to 4 Latch	6-63
Alarm 1 To 4 OFF Delay	6-66
Alarm 1 to 4 ON Delay	6-65
Alarm 1 to 4 Type	4-30, 6-44
Alarm 1 to 4 Upper Limit	4-34
Alarm Lower Limit Value	4-34
Alarm SP Selection	6-75
Alarm Upper Limit Value	4-34
Alarm Value 1 to 4	4-34, 6-14
Alarm Value Lower Limit 1 to 4	6-15
Alarm Value Upper Limit 1 to 4	6-15
Alpha	6-60
AT Calculated Gain	6-61
AT Calculation Gain	4-23
AT Execute/Cancel	4-23, 6-19
AT Hysteresis	4-23, 6-61
Auto/Manual Select Addition	5-31, 6-67
Auto/Manual Switch	6-9
Automatic Display Return Time	6-62
Auxiliary Output 1 to 4 Assignment	4-15, 5-7, 6-73
Auxiliary Output 1 to 4 Open in Alarm	6-58
Changed Parameter Only	6-5
Cold Junction Compensation Method	6-64
Communications Baud Rate	6-84
Communications Data Length	6-84
Communications Parity	6-84
Communications Stop Bits	6-84
Communications Unit No.	6-84
Communications Wait Time	6-84
Communications Writing	6-20
Control Output 1 Assignment	6-72
Control Output 1 Signal	6-49
Control Output 2 Assignment	6-72
Control Output 2 Signal	6-49
Control Period (Cooling)	6-43
Control Period (Heating)	6-43
Dead Band	5-8, 6-28
Decimal Point	6-40
Derivative Time	6-27
Derivative Time (Cooling)	4-13, 5-9, 6-28
Digit Shift	6-79
Direct/Reverse Operation	6-44
Display Brightness	6-63
Display Refresh Period	6-83
Event Input Assignment	5-12
Event Input Assignment 1 to 6	6-51
event inputs	5-11
Extraction of Square Root Enable	5-44, 6-53
Extraction of Square Root Low-cut Point	5-44, 6-33
HB ON/OFF	6-58
Heater Burnout Detection 1	6-21
Heater Burnout Detection 2	6-22
Heater Burnout Hysteresis	6-59

Heater Burnout Latch	6-59	Password to Move to Protect Level	6-6
Heater Current 1 Value Monitor	6-10, 6-21	PF Setting	6-35, 6-36, 6-79
Heater Current 2 Value Monitor	6-11, 6-22	PID ON/OFF	6-41
Heating/Cooling Tuning Method	5-9, 6-78	PID ON/OFF parameter	4-21
HS Alarm 1	6-23	Process Value Input Shift	5-3
HS Alarm 2	6-24	Process Value Slope Coefficient	5-3
HS Alarm Hysteresis	6-69	Process Value/Set Point 1	6-8
HS Alarm Latch	6-69	Process Value/Set Point 2	6-8
HS Alarm Use	4-42, 6-68	Program Pattern	5-37, 6-43
Hysteresis	4-20	Program Start	6-12
Hysteresis (Cooling)	6-29	Proportional Band	6-27
Hysteresis (Heating)	6-29	Proportional Band (Cooling)	4-13, 5-9, 6-28
Initial Setting/Communications Protect	6-4	Protocol Setting	6-84
Input Digital Filter	6-61	PV Decimal Point Display	6-82
Input Type	6-39, A-18	PV Rate of Change Calculation Period	4-35, 6-78
input type	4-10	PV Status Display Function	6-82
Integral Time	6-27	PV/MV (Manual MV)	6-37
Integral Time (Cooling)	4-13, 5-9, 6-28	PV/SP Display Selection	6-8
Integral/Derivative Time Unit	6-27, 6-28, 6-60	PV/SP No. 1 Display Selection	4-49, 6-8, 6-81
Integrated Alarm Assignment	5-24, 6-74	PV/SP No. 2 Display Selection	4-49, 6-8, 6-81
LBA Band	5-29, 6-71	Remote SP Enable	5-55, 6-75
LBA Detection Time	5-29, 6-70	Remote SP Input	5-55, 6-75
LBA Level	5-29, 6-70	Remote SP Input Shift	5-55
Leakage Current 1 Monitor	6-11, 6-23	Remote SP Input Slope Coefficient	5-55, 6-27
Leakage Current 2 Monitor	6-12, 6-24	Remote SP Lower Limit	5-55, 6-76
Limit Cycle MV Amplitude	4-24, 6-61	Remote SP Monitor	5-55, 5-56, 6-9
Loop Burnout Alarm (LBA)	5-28	Remote SP Upper Limit	5-55, 6-76
Manual Control Level	5-32	RT	6-68
Manual MV Initial Value	5-32, 6-67	RT (Robust Tuning)	6-68
Manual MV Limit Enable	5-32, 6-77	RUN/STOP	6-13
Manual Output Method	6-67	Scaling Lower Limit	6-40
Manual Reset Value	6-29	Scaling Upper Limit	6-40
Minimum Output ON/OFF Band	6-79	Set Point During SP Ramp	6-10
Monitor/Setting Item 1 to 5	6-80	Set Point Lower Limit	5-15
Monitor/Setting Item Display 1 to 5	6-35	Set Point Upper Limit	5-15
Move to Advanced Function Setting Level	6-53	Setting Change Protect	6-5
Move to Calibration Level	6-83	Soak Time	5-37, 5-38, 6-30
Move to Protect Level	6-3	Soak Time Remain	6-13
Move to Protect Level Time	6-64	Soak Time Unit	6-74
Move to the Protect Level	5-20	SP Lower Limit	6-41
Moving Average Count	5-3, 6-62	SP Mode	5-55, 5-56, 6-20
Multi-SP Set Point Selection	6-9	SP Ramp Fall Value	5-17, 6-32
MV (Manual MV)	6-37	SP Ramp Set Value	5-17, 6-32
MV at Error	6-31	SP Ramp Time Unit	6-56
MV at PV Error	5-43	SP Tracking	5-55, 5-56, 6-77
MV at Stop	5-42, 6-31	SP Upper Limit	6-41
MV at Stop and Error Addition	6-66	SP0 to SP7	6-25
MV Change Rate Limit	5-46, 6-33	ST (self-tuning)	6-42, 6-60
MV Display	6-62	ST Stable Range	6-60
MV Display Selection	4-49, 6-81	Standard or Heating/Cooling	6-42
MV Lower Limit	6-32	Standby Sequence Reset	6-57
MV Monitor (Cooling)	6-16	SV Status Display Function	6-83
MV Monitor (Heating)	6-16	Temperature Unit	6-40
MV Upper Limit	6-32	Transfer Output Lower Limit	6-50
Number of Multi-SP Points	5-11, 5-14, 6-56	Transfer Output Signal	6-49
Operation/Adjustment Protect	6-4	Transfer Output Type	5-34, 6-49
Parameter Initialization	6-56	Transfer Output Upper Limit	6-50
Parameter Mask Enable	6-6	Wait Band	5-38, 6-30
password	5-20	Work Bit 1 to 8 OFF Delay	6-34

Work Bit 1 to 8 ON Delay	6-34
password	5-20, 5-21
setting	5-21
PF Key (ⓀPF Key)	3-6, 3-7, 5-20, 5-32, 5-48, 6-5
PF setting	5-48
PID constants	4-23, 4-25
PID control	4-13
power supply	2-16
process value/set point 1	4-49
process value/set point 2	4-49
program end	5-39
program end output	5-39
proportional action	4-28
proportional band	4-29
Protect Level	6-3, A-26
protection	5-19
Initial Setting/Communications Protect	5-19
Operation/Adjustment Protect	5-19
PF Key Protect	5-20
Setting Change Protect	5-20
PV change rate alarm	4-35
PV status display	5-51

R

ratings	A-2
registering calibration data	7-2
remote SP input	2-20
remote SP input compensation	5-56
resistance thermometer calibration	7-7
RS-485	1-4, 2-21, A-5
RT (Robust Tuning)	4-26
run/stop control	5-12

S

sampling cycle	1-2, 4-35, A-4
sensor input setting ranges	A-30
set point limiter	5-15
set points 0 to 7	6-9
setting levels diagram	A-31
setting monitor/setting items	5-49
setting output specifications	4-14
setting the input type	4-10
setting the set point (SP)	4-19
setting the SP upper and lower limit values	5-15
Setup Tool ports	2-23, 2-24, 3-7
Shift Key (ⓀPF Key)	3-7
shifting input values	5-3
shifting inputs	5-3
simple program function	5-37
starting method	5-38
SP ramp	5-17
alarms	5-18
operation at startup	5-17
restrictions	5-18
SP0 to SP7	5-11
specifications	A-2
ST (self-tuning)	4-25

startup conditions	4-25
ST stable range	4-26
standby sequences	4-37
standard control	6-42
SV status display	5-51
switching the SP mode	5-13

T

temperature unit	4-12
terminal arrangement	2-7
terminal block wiring examples	
E5CC	2-7
E5EC	2-11
thermocouple calibration	7-4
thermocouple or infrared temperature sensor	7-13
three-position control	5-10
transfer output	2-20, 5-34
transfer output signal	5-34
transfer scaling	5-34
troubleshooting	A-13

U

Up Key (Ⓚ Key)	3-6
USB-Serial Conversion Cable	2-23, 2-25, A-8
user calibration	7-2
using the terminals	2-7

W

wiring	2-16
wiring precautions	2-16
work bit 1 to 8	5-60

OMRON Corporation Industrial Automation Company

Tokyo, JAPAN

Contact: www.ia.omron.com

Regional Headquarters

OMRON EUROPE B.V.

Wegalaan 67-69-2132 JD Hoofddorp
The Netherlands

Tel: (31)2356-81-300/Fax: (31)2356-81-388

OMRON ELECTRONICS LLC

One Commerce Drive Schaumburg,
IL 60173-5302 U.S.A.

Tel: (1) 847-843-7900/Fax: (1) 847-843-7787

OMRON ASIA PACIFIC PTE. LTD.

No. 438A Alexandra Road # 05-05/08 (Lobby 2),
Alexandra Technopark,
Singapore 119967

Tel: (65) 6835-3011/Fax: (65) 6835-2711

OMRON (CHINA) CO., LTD.

Room 2211, Bank of China Tower,
200 Yin Cheng Zhong Road,
PuDong New Area, Shanghai, 200120, China

Tel: (86) 21-5037-2222/Fax: (86) 21-5037-2200

Authorized Distributor:

D3E Electronique

Parc du Grand TROYES
3 Rond Point Winston CHURCHILL
10302 SAINTE SAVINE

Tél: 03 25 71 31 65 Fax: 03 25 74 38 82

Email: electronique@d3e.fr www.d3e.fr

© OMRON Corporation 2011 All Rights Reserved.
In the interest of product improvement,
specifications are subject to change without notice.

Cat. No. H174-E1-01

1211